

OSA20

Optical Spectrum Analyzer

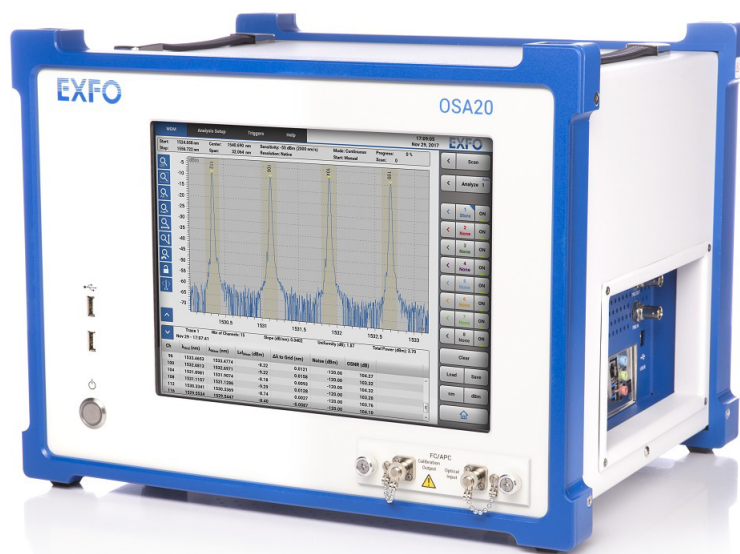

Copyright

Copyright © 2018–2023 EXFO Inc. All rights reserved. No part of this publication may be reproduced, stored in a retrieval system or transmitted in any form, be it electronically, mechanically, or by any other means such as photocopying, recording or otherwise, without the prior written permission of EXFO Inc.(EXFO).

Information provided by EXFO is believed to be accurate and reliable. However, no responsibility is assumed by EXFO for its use nor for any infringements of patents or other rights of third parties that may result from its use. No license is granted by implication or otherwise under any patent rights of EXFO.

EXFO's Commerce And Government Entities (CAGE) code under the North Atlantic Treaty Organization (NATO) is 0L8C3.

The information contained in this publication is subject to change without notice.

Trademarks

EXFO's trademarks have been identified as such. However, the presence or absence of such identification does not affect the legal status of any trademark.

Units of Measurement

Units of measurement in this publication conform to SI standards and practices.

Patents

The exhaustive list of patents is available at www.EXFO.com/patent.

Version number: 2.0.0.4

Information in this document applies to the OSA20 2.0.x system version.

Contents

Copyright	ii
Regulatory Information	vi
1 Introducing the OSA20	1
Technical Specifications	1
Product Overview	4
Conventions	11
2 Safety Information	13
Other Safety Symbols on Your Unit	14
Laser Safety Information	15
Electrical Safety Information	16
3 Getting Started with Your OSA20	19
Unpacking and Installing the OSA20	19
Connecting the OSA20 to a Power Source	21
Connecting a Light Source to the OSA20	23
Connecting a Mouse and Keyboard to the OSA20	24
Sharing the OSA20 Display with an External Screen	25
Turning on the OSA20 and Accessing the Home Window	26
Turning off the OSA20	27
Updating the OSA20 System Version	28
Updating the Operating System Version (Security Updates)	30
4 Setting Up Your OSA20	31
Setting the Screen Brightness	31
Setting Spectral and Power Units	31
Setting the Date and Time	31
Accessing an Analysis Mode	33
5 Performing Measurement Scans	37
Defining the Scan Parameters	37
Zeroing the Dark Current	43
Manually Starting/Stopping the Optical Spectrum Acquisition	45
Triggering the Optical Spectrum Acquisition	46
Generating Output Trigger Signals	47
6 Configuring and Displaying Scan Traces	49
Operating Scan Traces	49
Handling Traces Files	55
Adjusting the Graph Display	56

7 Analyzing Traces	61
Setting Up Peaks and Troughs Search	66
Selecting the Component Under Test (PCT Mode)	69
Setting Up Channel Detection	70
Setting Up Spectral Width Analysis	76
Setting Up XXdB Width Analysis	81
Setting Up Mean Wavelength/Frequency Analysis	84
Analyzing Central Wavelength and Sigma Value Results	86
Analyzing FWHM Results	87
Analyzing Side Modes Spacing Results	88
Setting Up Notch Width Analysis	89
Setting Up Level Check Analysis	92
Setting Up SMSR Analysis	94
Setting Up OSNR Analysis	97
Setting Up Ripple Analysis	103
Setting Up Optical Power Analysis	105
Setting Up Loss Measurement Analysis	107
Setting Up Peak Power Density Analysis	108
Setting Up Gain and Noise Figure Analysis	109
Setting Up Pass Band Test Analysis	113
Setting Up Stop Band Test Analysis	119
Setting Up Mask Test Analysis	125
8 Handling Files and User Data	127
Connecting/Disconnecting USB Storage Devices	127
Saving Analysis Settings and Results	127
Loading Measurement and Analysis Settings	129
Handling Files Saved	130
Deleting all User Data from the OSA20 Internal Drive	130
Restoring Factory Settings	131
9 Using the OSA20 in Remote Control	133
Preparing the OSA20 for Remote Control	133
Entering/Exiting the Remote Mode	136
10 Performing Basic Maintenance Operations	137
Cleaning the OSA20	137
Cleaning Optical Connectors	139
Performing a User Calibration	140
Replacing the External Power Fuse	141
Recalibrating the OSA20	142
Carrying the OSA20	142
Recycling and Disposal	142
11 Troubleshooting	143
Handling Errors and Warnings	143
Forcing the OSA20 to Shutdown & Restart	147
Using Remote Assistance Tools	148
Displaying the User Documentation	148
Contacting the Technical Support Group	149
Transportation	149

12 Warranty	151
General Information	151
Gray Market and Gray Market Products	151
Liability	152
Exclusions	152
Certification	152
Service and Repairs	153
EXFO Service Centers Worldwide	154

Regulatory Information

USA Electromagnetic Interference Regulatory Statement

Electronic test and measurement equipment is exempt from FCC part 15, subpart B compliance in the United States of America. However, EXFO Inc. makes reasonable efforts to ensure compliance to the applicable standards.

The limits set by these standards are designed to provide reasonable protection against harmful interference when the equipment is operated in a commercial environment. This equipment generates, uses, and can radiate radio frequency energy and, if not installed and used in accordance with the user documentation, may cause harmful interference to radio communications. Operation of this equipment in a residential area is likely to cause harmful interference in which case the user will be required to correct the interference at his own expense.

Modifications not expressly approved by the manufacturer could void the user's authority to operate the equipment.

Canada Electromagnetic Interference Regulatory Statement

This equipment generates, uses, and can radiate radio frequency energy and, if not installed and used in accordance with the instruction manual, may cause harmful interference to radio communications. Operation of this equipment in a residential area is likely to cause harmful interference.

Cet équipement génère, utilise et peut émettre de l'énergie radio-fréquence et, s'il n'est pas installé et utilisé conformément à la documentation de l'utilisateur, il peut occasionner une interférence néfaste aux communications radio. L'utilisation de cet équipement dans une zone résidentielle est susceptible d'occasionner une interférence néfaste.

Caution: This equipment is not intended for use in residential environments and may not provide adequate protection to radio reception in such environments.

Attention: Cet appareil n'est pas destiné à être utilisé dans des environnements résidentiels et peut ne pas assurer la protection adéquate à la réception radioélectrique dans ce type d'environnements.

This is a class A, group 1 product.

- **Class A equipment:** Equipment that is, by virtue of its characteristics, highly unlikely to be used in a residential environment, including a home business shall be classified as class A and shall comply with the class A limits specified in the applicable ICES standard. Characteristics considered in this assessment include price, marketing and advertising methodology, the degree to which the functional design inhibits applications suitable to residential environments, or any combination of features that would effectively preclude the use of such equipment in a residential environment.

Classe A: Matériel qui, en raison de ses caractéristiques, ne sera fort probablement pas utilisé dans un milieu domiciliaire ni par des entreprises établies à domicile. Parmi les caractéristiques considérées dans cette évaluation, il y a le prix, les méthodes de commercialisation et de publicité, la mesure dans laquelle les fonctions de l'appareil font qu'il ne se prête pas à des applications convenant au milieu domiciliaire ou toute

combinaison de ces caractéristiques qui aurait pour conséquence d'en prévenir effectivement l'utilisation à domicile. Utilisé également pour indiquer les limites d'émission correspondantes qui s'appliquent à un tel matériel.

- Group 1 equipment: group 1 contains all equipment which is not classified as group 2 equipment, and includes equipment such as laboratory and scientific equipment, industrial process, measurement and control equipment.

Group 2 equipment: group 2 contains all ISM RF equipment in which radio-frequency energy in the frequency range 9 kHz to 400 GHz is intentionally generated and used or only used locally, in the form of electromagnetic radiation, inductive and/or capacitive coupling, for the treatment of material for inspection/analysis purposes, or for transfer of electromagnetic energy.

Appareils du groupe 1 : le groupe 1 réunit tous les appareils compris dans le domaine d'application de la présente Norme, qui ne sont pas classés comme étant des appareils du groupe 2. Le groupe 1 inclut les appareils scientifiques et de laboratoire, les processus industriels, appareils de mesure ou de contrôle.

Appareils du groupe 2 : le groupe 2 réunit tous les appareils ISM à fréquences radioélectriques dans lesquels de l'énergie à fréquences radioélectriques dans la plage de fréquences comprises entre 9 kHz et 400 GHz est produite et utilisée volontairement ou uniquement utilisée localement sous forme de rayonnement électromagnétique, de couplage inductif et/ou capacitif, pour le traitement de la matière, à des fins d'examen ou d'analyse ou pour le transfert d'énergie électromagnétique.

Supplier's Declaration of Conformity (SDoC)

The SDoC for your product is as follows:

CAN ICES-001 (A) / NMB-001 (A)

EU and UK Electromagnetic Compatibility Regulatory Statement

Warning: This is a class A product. In a domestic environment, this product may cause radio interference in which case the user may be required to take adequate measures. Your product is suitable for use in industrial electromagnetic environments.

EU and UK Declaration of Conformity

The full text of the declaration of conformity is available at the following Internet address: www.exfo.com/en/resources/legal-documentation.

1 Introducing the OSA20

The OSA20 is a diffraction-grating based optical spectrum analyzer, using a touch sensitive display with multi-touch gesture control. It provides an extensive suite of built-in analysis functions enabling input signal measurement and analysis for many common applications.

A wide range of communication ports allows remote control operations and export of data.

The OSA20 features one general analysis mode and seven application-oriented modes. Each analysis mode has a full suite of analysis functions for a detailed spectrum analysis.

Technical Specifications



IMPORTANT

The following technical specifications can change without notice. The information presented in this section is provided as a reference only. To obtain this product's most recent technical specifications, visit the EXFO Web site at www.exfo.com.

Optical Measurement		
Wavelength	Spectral range	1250–1700 nm / 239.834–176.349 THz
	Span range	0.5 nm to full range (450 nm)
	Linearity ^a	±6 pm over 1500–1640 nm, ±20 pm over full range / 2.5 GHz @ 1550 nm
	Accuracy ^a	±10 pm over 1500–1640 nm, ±25 pm over full range / 2.5 GHz @ 1550 nm
	Repeatability	±2 pm / 0.25 GHz @ 1550 nm
	Sampling resolution	2 pm / 0.25 GHz @ 1550 nm
	Sampling points	251 (span of 0.5 nm) to 225,001 (span of 450 nm)
	Reference	Built-in ELED (safety class 1) + Acetylene cell (user calibration by patch cord) Acetylene gas is a NIST standard Reference Material SRM 2517a. The P9 line is used in the case of OSA20
Monochromator	Resolution bandwidth ^{b, c, d}	20 pm native, adjustable over 50–2000 pm with 1 pm step
	Dynamic range (ORR) ^e	≥ 30 dB (> 35 dB typ.) beyond ±50 pm from peak ≥ 50 dB (> 55 dB typ.) beyond ±100 pm from peak ≥ 60 dB (> 63 dB typ.) beyond ±200 pm from peak
	Stray light suppression ratio ^f	≥ 73 dB

Introducing the OSA20

Technical Specifications

Optical Measurement			
Optical power	Input power per channel	≤ 20 dBm	
	Total safe power	≤ 25 dBm	
	Level sensitivity ^g	single scan	High (0.5 nm/s): < -76 dBm (-78 dBm typ.)
		with averaging (Avg Nb of scans) ^h	High (0.5 nm/s): -80 dBm (Avg 3), -85 dBm (Avg 30), -90 dBm (Avg 380) -75 dBm (2 nm/s): -80 dBm (Avg 7), -85 dBm (Avg 70), -90 dBm (Avg 800)
	Absolute level accuracy ^{a, i}		± 0.4 dB at 1310 nm and 1550 nm
	Level linearity ^j		± 0.07 dB over the full range (input level -50 to +3 dBm)
	Level/wavelength flatness ^k		± 0.15 dB over 1500–1640 nm, ± 0.25 dB over 1260–1680 nm
	Level sampling		± 0.01 dB over -60 to +20 dBm
Sweep speed	Sensitivity ^g	-55 dBm at 2000 nm/s to -75 dBm at 2 nm/s	
	Sweep cycle/100 nm ^l	300 ms typ.	
	Sampling rate	1 MHz typ.	

- a. After user calibration performed after 1 hour warm-up time.
- b. Native 17–24 pm over 1500–1620 nm (except in -55 dBm sensitivity), 17–26 pm over 1250–1700 nm.
- c. Adjustable resolution bandwidth is calculated from the native bandwidth.
- d. Adjustable over 6–400 GHz with 0.1 GHz step on the abscissa in THz.
- e. HeNe laser at 1523 nm with ± 2 nm span.
- f. Laser at 1523 nm with ± 50 nm span, excluding ± 2 nm around peak.
- g. Noise level of 99 % of all data points over 1520–1620 nm.
- h. Typical values.
- i. Over 18–28°C all sensitivity settings except ± 0.6 dB in -55 dBm and Burst sensitivities.
- j. Measured @ 1310 nm and 1500 nm, except ± 0.3 dB in -55 dBm and Burst sensitivities.
- k. Except ± 0.35 dB in -55 dBm and Burst sensitivities, except for water absorption lines, over 18–28°C all sensitivity settings.
- l. Sweep cycle /100 nm at -60 dBm sensitivity at center wavelength of 1475 nm.

The validity of specifications depends on operating conditions (see *Recalibrating the OSA20* on page 142).

Interfaces and Electrical		
Optical interfaces	Optical input	SMF-28 type fiber
	User calibration output	Built-in ELED (safety class 1) + Acetylene cell (user calibration by patch cord)
	Connector (input and output)	FC/APC or FC/PC or SC/APC or SC/PC
	Return loss	> 38 dB (> 42 dB typ.) at 1310 nm and at 1550 nm (APC connector)
External devices	Screen	VGA Port (x1), DVI-D Port (x1), HDMI (x1)
	Mouse, keyboard, hard disk...	USB 2.0-A (x4), USB 3.0-A (x2)
	Serial ports (unused)	Male SUBD-9 (x2)
	Sound ports (unused)	Line-in (x1), Line-out (x1), Microphone (x1)
Remote interfaces	Ethernet (2x RJ45)	1 GB/s max.
	GPIO (1x IEEE 488)	7.2 MB/s max.
	USB (1x USB 2.0-B)	115 kB/s max.
Triggers	Trigger In (BNC)	High level: >3 V Low level: <2 V Input maximum range: 0–5.5 V
	Trigger Out (BNC)	High level: 4.5 to 5 V on high-impedance load (> 10 kΩ) Low level: 0 to 0.5 V on high-impedance load (> 10 kΩ)
Physical specifications	Display screen	12 inch capacitive touch-screen (res. 1024 x 768)
	Data Storage capacity	256 GB
	Dimensions & weight	W 413 x H 314 x D 385 mm, 15 kg
	Available accessory	Rack mount kit

Product Overview

The OSA20 is delivered with the following accessories:

- 1 front panel protective cover
- 1 power supply cord
- 1 AC/DC power adapter (fastened on the rear panel)
- 1 capacitive touch screen stylus
- 1 manual *Getting Started with OSA20*
- 1 USB key containing the system version installed on the OSA20 and the available drivers, examples, reports and user documentation.

Front Panel

The OSA20 is delivered with a protective cover fastened on the front panel.

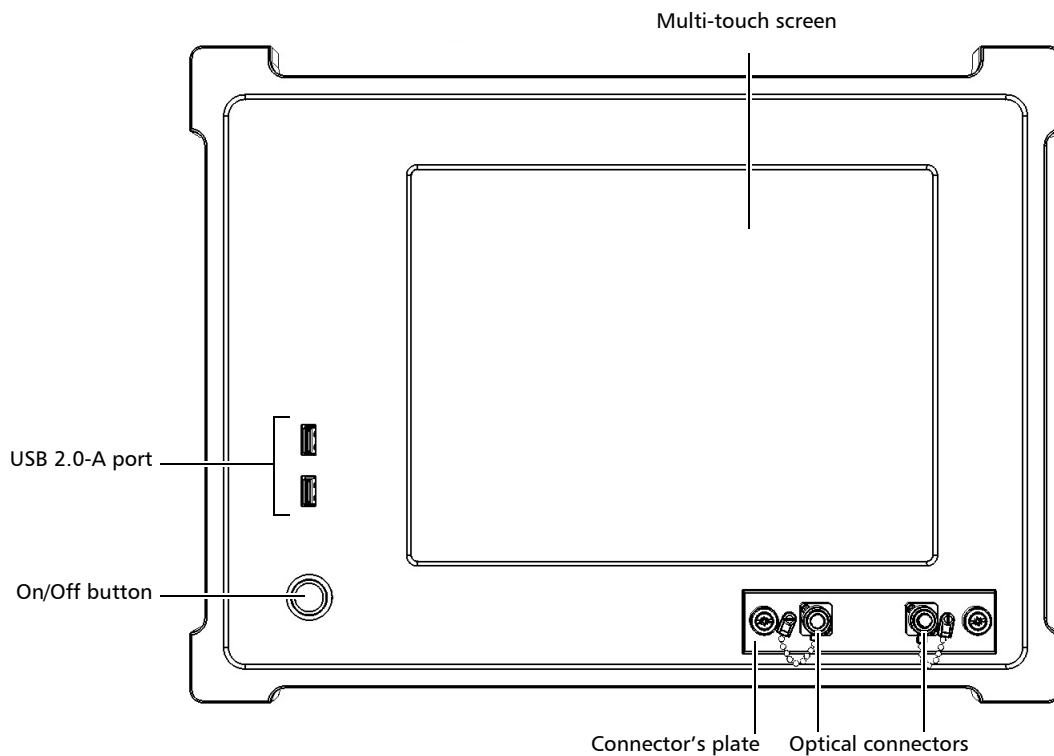

On/Off button

The  label identifies the On/Off button that enables you to turn on or off the OSA20 (see *Turning on the OSA20 and Accessing the Home Window* on page 26).

Multi-touch Screen

The multi-touch screen enables you to perform all possible operations on the OSA20.

To select a parameter, command or function on the screen, touch the corresponding command with the tip of your finger or the stylus, without tapping it.

The following gestures are available on the multi-touch screen:

Gesture	Description
Touch	Gently touch something on the screen with your finger or the stylus to select it.
Pan	Drag your finger or the stylus across the screen.
Pinch/Stretch	Pinch two fingers together or move them apart to zoom in or out: <ul style="list-style-type: none"> ➤ To zoom in, touch two points on the screen and move your fingers away from each other. ➤ To zoom out, touch two points on the screen and move your fingers toward each other.
Long press	Hold your finger or stylus on the graph until a complete circle appears around it to automatically activate the rectangle zoom (see <i>Adjusting the Scale of the Graph</i> on page 56).

USB ports

The  label identifies the two USB 2.0 type-A ports located on the front panel. They enable you to connect USB devices such as:

- Keyboard and mouse if needed (see *Connecting a Mouse and Keyboard to the OSA20* on page 24)
- USB key or hard disk to export your measurement results
- An external multi-touch screen

The USB ports are SELV classified; you must only connect them to interfaces of the same type.

Optical Connectors

The two following optical connectors, protected by a dust cap, are located on the front panel:

- The **Calibration Output** label identifies the ELED and acetylene source output, used for user calibration of the wavelength (see *Performing a User Calibration* on page 140).
The  label indicates an injury hazard. The user calibration output requires special safety instructions for proper use: see *Performing a User Calibration* on page 140.
- The **Optical Input** label identifies the optical input, used to connect a light source.
The two optical connectors are mounted on a plate, which enables you to access the internal optical connectors for cleaning (see *Cleaning Optical Connectors* on page 139).

Left-side Panel: Cooling Fan

The cooling fan, located on the left-side panel of the OSA20, extracts warm air from inside. A cover grid protects it.

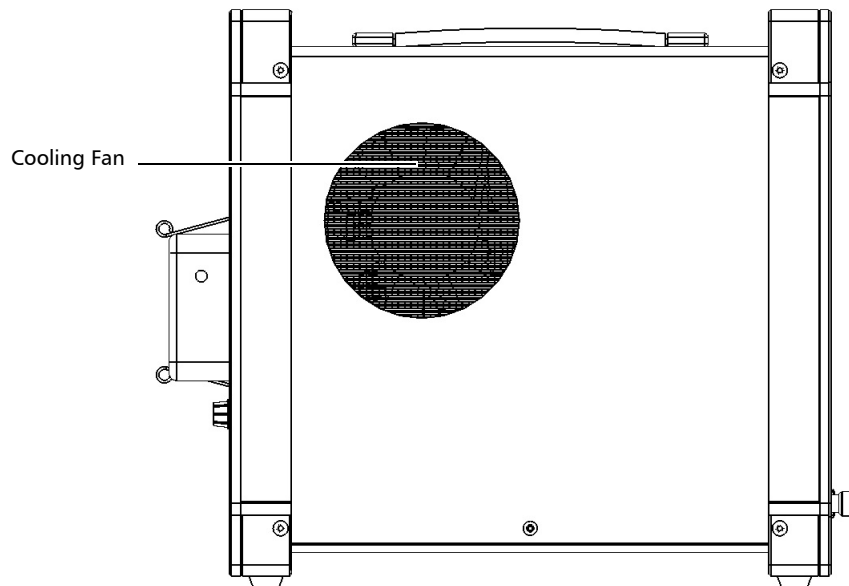

Right-side Panel: Connectors

The right-side panel of the OSA20 contains:

- A complete set of communication ports and interfaces for remote control and export of data.
All ports and interfaces are SELV classified and must only be connected to interfaces of the same type.
- Ventilation holes for air input.

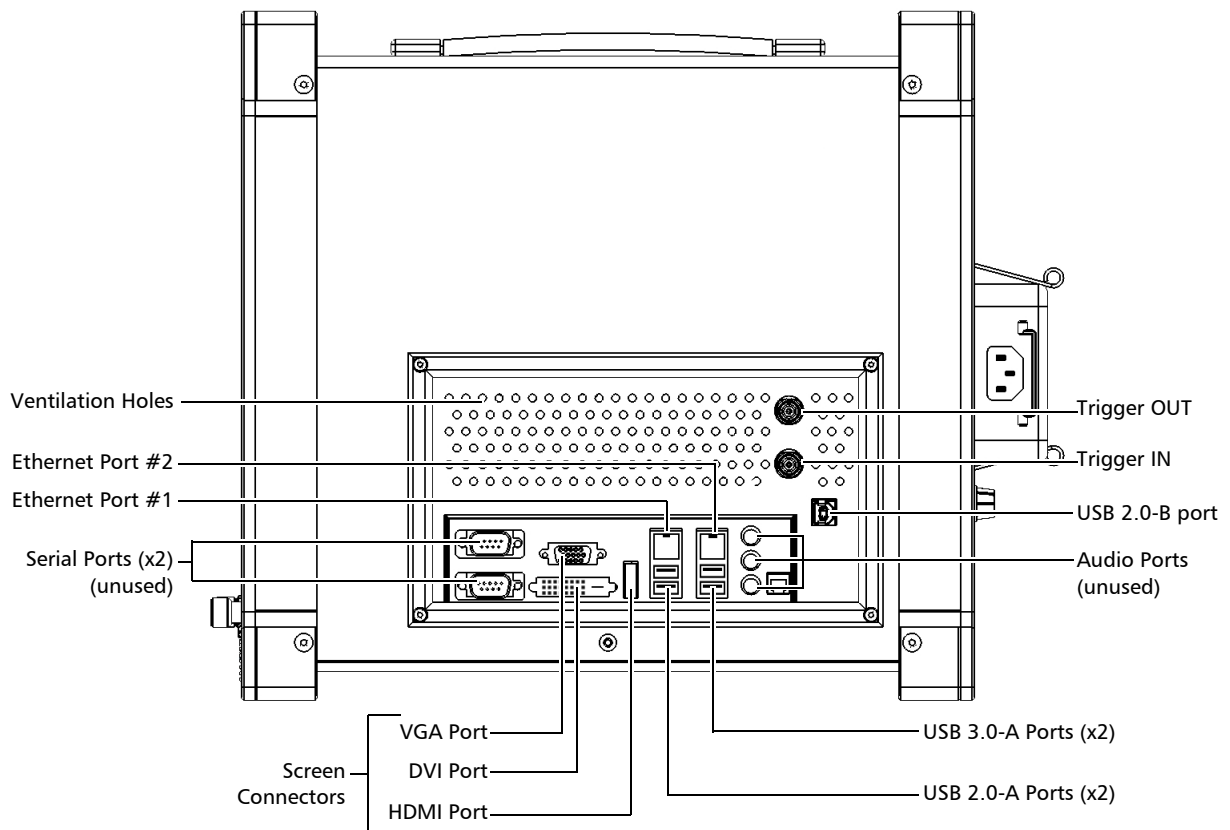

External Screen Connectors

You can connect an external screen to the following ports:

- **VGA** port
- **DVI** port
- **HDMI** port

For more details on how to configure the external screen settings, see *Sharing the OSA20 Display with an External Screen* on page 25.

Trigger Ports

The trigger ports enable you to synchronize scans with a signal (see *Interfaces and Electrical* on page 3 for more details on signal levels).

- **TRIG OUT:** BNC connector for outputting trigger signals. For more details, see *Generating Output Trigger Signals* on page 47.
- **TRIG IN:** input BNC connector for starting scan in synchronization with an external trigger signal, as described in *Triggering the Optical Spectrum Acquisition* on page 46.

In RLT mode, this port is used as a gate: see paragraphs **RLT – Recirculating Loop Transmission on page 33** and **Gate Acquisition (RLT mode only) on page 41**.

USB Ports

- **USB 2.0-A** and **USB 3.0-A**: these ports enable you to connect USB devices such as:
 - Keyboard and mouse if needed (see *Connecting a Mouse and Keyboard to the OSA20* on page 24)
 - USB key or hard disk to export your measurement results
 - An external multi-touch screen

The USB ports are SELV classified; you must only connect them to interfaces of the same type.

- **USB 2.0-B**: this port enables you to perform remote control operations from a connected computer. For more information, see *Using the OSA20 in Remote Control* on page 133.

Ethernet Ports

The two Ethernet ports enable you to perform remote control operations.

- Ethernet port #1:

This port is associated with a DHCP server. It can be used to connect directly a computer that will be assigned automatically an IP address.

- Ethernet port #2:

You can configure this port manually or automatically through a remote DHCP server.

For more information, *Using the OSA20 in Remote Control* on page 133.



IMPORTANT

The Ethernet ports can only be used for remote control of the OSA20. Any other use is not possible.

Audio and Serial Ports

Unused ports.

Rear Panel

The rear panel holds the power adapter, power switch, fuse holder and GPIB connector.

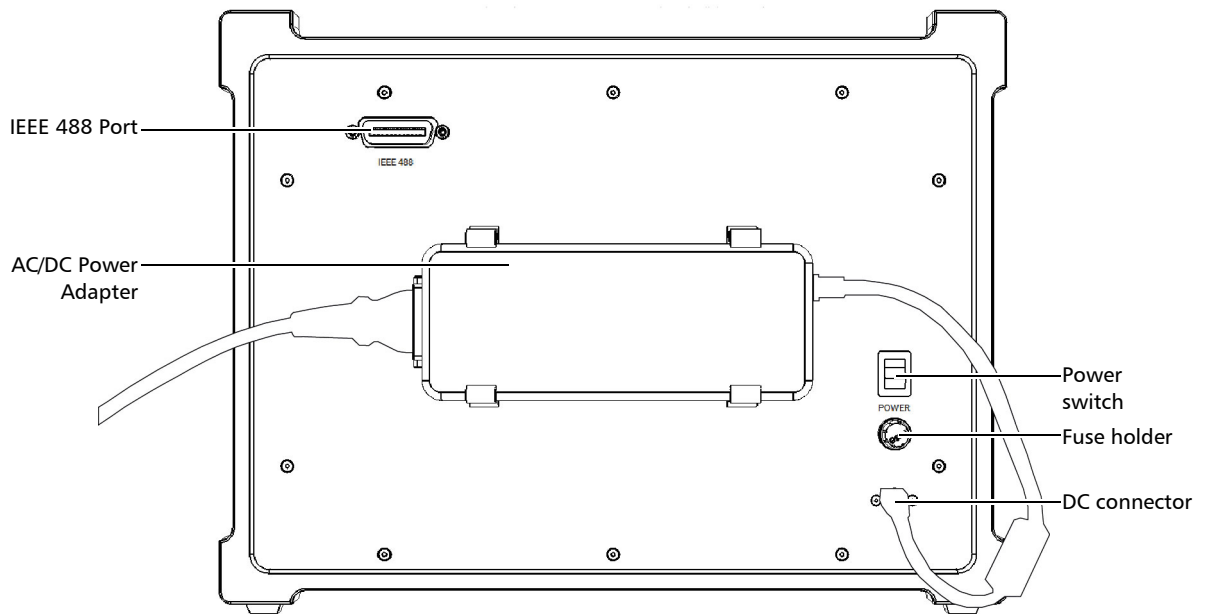

IEEE 488 Port

This port (also known as GPIB port) enables you to perform remote control operations. For more information, see *Using the OSA20 in Remote Control* on page 133.

The IEEE 488 port is SELV classified; you must only connect it to interfaces of the same type.

AC/DC Power Adapter and Power Cord

The AC/DC power adapter is fastened on the rear panel for convenient purpose.

It is plugged to the 48 V DC connector, identified by the  label.



CAUTION

To ensure the smooth functioning of the OSA20, you must only use the power adapter provided by EXFO.

The 48 V DC connector is SELV classified and must only be connected to interfaces of the same type.











Fuse Holder

The fuse holder contains a fuse (see *Technical Specifications* on page 1 for fuse type) to protect the OSA20 from overcurrent.

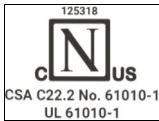
Introducing the OSA20

Product Overview

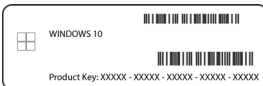
Labels and Markings

Label	Description
	<p>Identification of the product</p> <p>Indicates serial number, model, options (if any), and date of manufacture.</p>
	<p>Manufacturer identification</p> <p>Contact information of the manufacturer.</p>
	<p>Fuse type (x2): see <i>Technical Specifications</i> on page 1.</p>
	<p>Indicates an injury hazard. It appears on a location that requires special instructions for proper use: see <i>Electrical Safety Information</i> on page 16.</p>
	<p>WEEE symbol for recycling</p> <p>See <i>Recycling and Disposal</i> on page 142.</p>
	<p>Safety certification label</p>
<p>CAN ICES-001 (A) / NMB-001 (A)</p>	<p>Canadian certification</p> <p>See <i>Regulatory Information</i> on page vi.</p>
	<p>UK conformity assessment</p> <p>See <i>Regulatory Information</i> on page vi.</p>
	<p>CE marking</p> <p>See <i>Regulatory Information</i> on page vi.</p>
	<p>EFUP label (RoHS China)</p> <p>See <i>Chinese Regulation on Restriction of Hazardous Substances (RoHS)</i> on page 155.</p>
	<p>Windows license label</p> <p>The OSA20 embeds Windows 10.</p>
	<p>Warranty seal</p> <p>The OSA20 cover must not be open, otherwise the warranty is not valid anymore.</p>

Conventions

Before using the product described in this guide, you should understand the following conventions:



WARNING

Indicates a potentially hazardous situation which, if not avoided, could result in *death or serious injury*. Do not proceed unless you understand and meet the required conditions.



CAUTION

Indicates a potentially hazardous situation which, if not avoided, may result in *minor or moderate injury*. Do not proceed unless you understand and meet the required conditions.



CAUTION

Indicates a potentially hazardous situation which, if not avoided, may result in *component damage*. Do not proceed unless you understand and meet the required conditions.



IMPORTANT

Refers to information about this product you should not overlook.

2 Safety Information



WARNING

Do not install or terminate fibers while a light source is active. Never look directly into a live fiber and ensure that your eyes are protected at all times.



WARNING

The use of controls, adjustments and procedures, namely for operation and maintenance, other than those specified herein may result in hazardous radiation exposure or impair the protection provided by this unit.



WARNING

If the equipment is used in a manner not specified by the manufacturer, the protection provided by the equipment may be impaired.



WARNING

Use only accessories designed for your unit and approved by EXFO. For a complete list of accessories available for your unit, refer to its technical specifications or contact EXFO.



IMPORTANT

Refer to the documentation provided by the manufacturers of any accessories used with your EXFO product. It may contain environmental and/or operating conditions limiting their use.



IMPORTANT

When you see the following symbol on your unit , make sure that you refer to the instructions provided in your user documentation. Ensure that you understand and meet the required conditions before using your product.



IMPORTANT

When you see the following symbol on your unit , it indicates that the unit is equipped with a laser source, or that it can be used with instruments equipped with a laser source. These instruments include, but are not limited to, modules and external optical units.



IMPORTANT











Other safety instructions relevant for your product are located throughout this documentation, depending on the action to perform. Make sure to read them carefully when they apply to your situation.

Safety Information

Other Safety Symbols on Your Unit

Other Safety Symbols on Your Unit

One or more of the following symbols may also appear on your unit.

Symbol	Meaning
	Direct current
	Alternating current
	The unit is equipped with an earth (ground) terminal.
	The unit is equipped with a protective conductor terminal.
	The unit is equipped with a frame or chassis terminal.
	On (Power)
	Off (Power)
 OR 	On/off (Power)
	Fuse

Laser Safety Information

Your instrument is in compliance with standards IEC 60825-1: 2007 and 2014.

Laser radiation may be encountered at the optical output port.

The following labels indicate that a product contains a Class 1 laser or LED source:

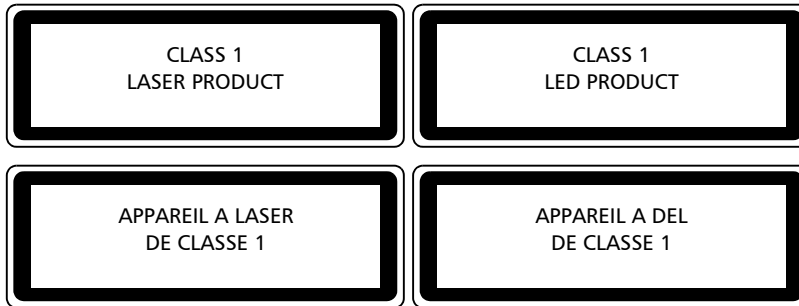

Complies with standards 21 CFR 1040.10, except for deviations pursuant to Laser Notice No. 50, dated June 24, 2007.

Electrical Safety Information

Your unit uses an external AC/DC power adapter connected to an international safety standard three-wire power cable.



WARNING

- Use the external power supply (AC/DC power adapter) indoors only.
- Never connect the unit to the AC mains (with the AC/DC power adapter) when it is used outdoors.
- Operation of any electrical instrument around flammable gases or fumes constitutes a major safety hazard.
- To avoid electrical shock, do not operate the unit if any part of the outer surface (covers, panels, etc.) is damaged.
- Only authorized personnel should carry out adjustments, maintenance or repair of opened units under voltage. A person qualified in first aid must also be present. Do not replace any components while the power cable is connected.
- Your unit is equipped with an internal replaceable clock battery to keep time and date accurate. Only authorized personnel can replace this battery. Attempting to replace it yourself could seriously compromise your safety.
- Use only fuses with the required rated current and specified type . Do not use repaired fuses or short-circuited fuse holders. For more information, see the section about replacing the fuses in this user documentation.
- Unless otherwise specified, all interfaces are intended for connection to Safety Extra Low Voltage (SELV) circuits only.
- Capacitors inside the unit may be charged even if the unit has been disconnected from its electrical supply.



WARNING

- Use only the listed and certified AC/DC power adapter provided by EXFO with your unit. It provides reinforced insulation between primary and secondary, and is suitably rated for the country where the unit is sold.



CAUTION

Position the unit so that the air can circulate freely around it.

Equipment Ratings		
Temperature	Operation	+5 °C to +40 °C (+41 °F to +104 °F) ^a
	Storage	-10 °C to +50 °C (+14 °F to 122 °F)

Equipment Ratings	
Performance guaranteed temperature	+18 °C to +28 °C (+64.4 °F to +82.4 °F)
Relative humidity ²	<ul style="list-style-type: none"> ▶ unit: 80 % for temperatures up to 31°C decreasing linearly to 50 % relative humidity at 40°C ▶ AC/DC power adapter: 5-95 % RH, non-condensing
Maximum operation altitude	< 2000 m (6562 ft)
Pollution degree	2
Overvoltage category	<ul style="list-style-type: none"> ▶ unit: II ▶ AC/DC power adapter: I
Measurement category	Not rated for measurement categories II, III, or IV
Input power ³	<ul style="list-style-type: none"> ▶ unit: 48 V --- ; 3 A (protected by fuse) ▶ AC/DC power adapter: 100 - 240 V ~ ; 50/60 Hz; 1.5 A (Output power: 48 V --- ; 3.13 A)

- a. Scan stops if temperature > 35°C



CAUTION

- ▶ The use of voltages higher than those indicated on the label affixed to your unit may damage the unit.

3 Getting Started with Your OSA20

This section explains how to properly install and connect the OSA20.

Unpacking and Installing the OSA20

This section explains how to install the OSA20 as a bench top instrument.

To install the OSA20 into a rack, EXFO has designed a special rack mount (for more details, contact your sales representative). The procedure to install the OSA20 into a 19-inch rack is available in the manual delivered with the rack mount kit.

The OSA20 is designed for indoor use only, and is not dedicated to wet locations. It must be operated under proper environment conditions, as explained in the following procedure.



CAUTION

- To ensure proper environment conditions, make sure the location where the OSA20 will be installed meets the environmental characteristics listed in *Technical Specifications* on page 1.
- Do not install the OSA20 near any source of heat or cold.
- To ensure proper ventilation and cooling, make sure there is sufficient clearance below, on top and at the sides of the OSA20 in the place where it will be installed.

To unpack and install the OSA20:

1. Open the package with care and remove the protective foam.



IMPORTANT

When unpacking, handle the device with care and do not damage the original shipping container in case the OSA20 needs to be returned to EXFO.

2. Remove the tape that closes the plastic bag, and open the plastic bag that contains the OSA20 to make visible the two handles.
3. Pull out the OSA20 vertically from its packaging: hold it by its two retractable handles and keep it horizontal.
4. Set the OSA20 on a flat stable surface free of excessive vibration.
5. Allow the flow of air to circulate freely around the OSA20 and remove any equipment or paper that could block the air flow. Ventilation holes are located on the right and bottom sides of the OSA20.
6. Do not place anything under or at the sides of the OSA20, as illustrated in the following figure.

Getting Started with Your OSA20

Unpacking and Installing the OSA20

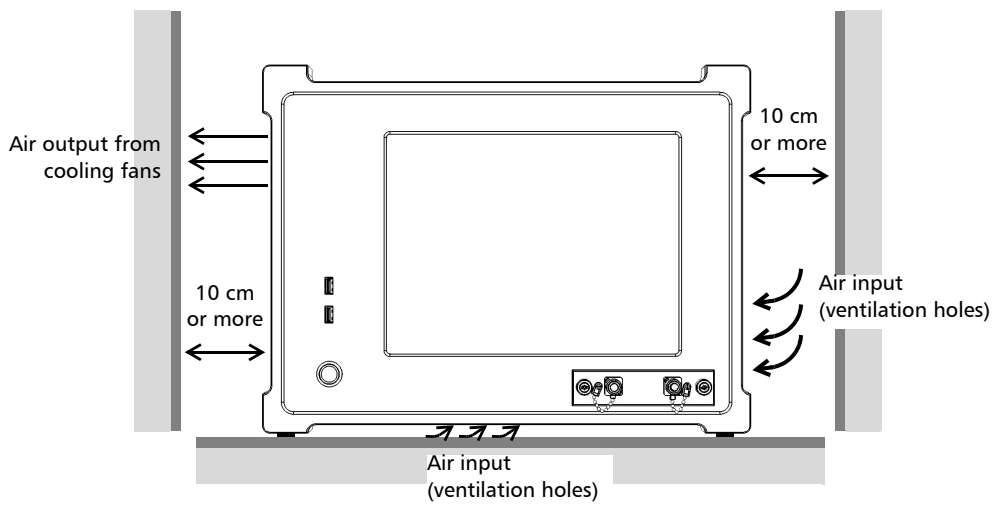

- 7.** On the rear panel (see *Rear Panel* on page 9), make sure the power switch is set to **O**.
- 8.** Remove the protective cover from the front panel:
 - 8a.** Hold your hands on the two lateral edges of the protective cover.
 - 8b.** Slightly splay the lateral edges of the protective cover to unfasten the two side tabs from the back of the front frame.
 - 8c.** Gently pull horizontally the protective cover out of the front panel.
- 9.** To tilt the OSA20 upward, deploy the two retractable legs located below it.

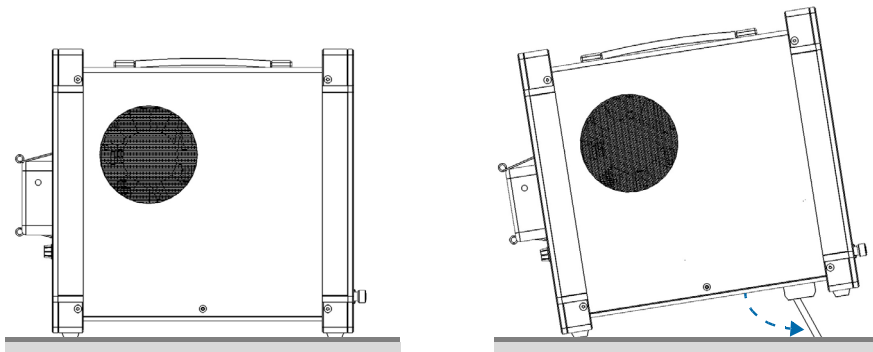

Connecting the OSA20 to a Power Source

The OSA20 is dedicated to be connected to a SELV circuit.

Connecting the OSA20 to the Wall Socket Using the Power Adapter

The OSA20 has a chassis connected to ground via the power supply cord. A protective ground connection by way of the grounding conductor in the power cord is essential for safe operation.

You must use the AC/DC adapter provided with the OSA20. For voltage specifications, see *Technical Specifications* on page 1.



WARNING

- Make sure the wall socket on which the OSA20 will be plugged is protected by a 16 A max circuit breaker.
- Make sure the OSA20 power source does not apply more than 265 Volts RMS between the supply conductors and the ground.
- To avoid the possibility of injury, make sure the socket outlet in which the power supply cord will be plugged is equipped with a protective ground contact, and that the electrical installation fulfills the local safety requirements.

To connect the OSA20 with the power adapter:

1. Make sure the AC/DC adapter is not plugged to the wall socket.
2. Make sure the power switch is set to **O**.
3. On the rear panel, connect the cord of the adapter to the 48 V connector.
4. Connect one end of the provided power supply cord to the AC/DC adapter located on the rear panel and plug the other end to the proper voltage wall socket outlet (to know the voltage requirement, see *Technical Specifications* on page 1).
5. On the rear panel, set the power switch to **I**.

Connecting the OSA20 to a 48 V DC Power Source

You can directly connect the OSA20 to a 48 V DC power source by following the instructions given in this section.

The following figure describes the 48 V connector located on the rear panel:

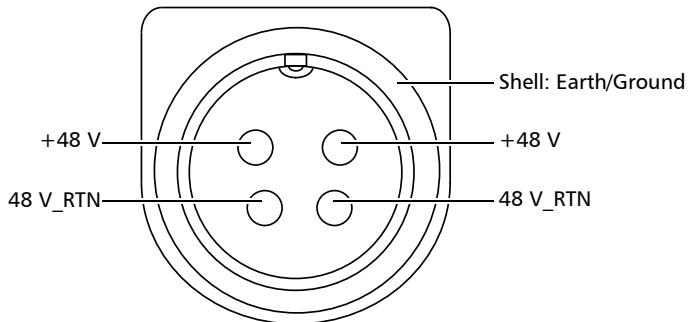

CAUTION

- Make sure the voltage of the power source is in the range 48–60 V and complies with the requirements of SELV circuit, as defined in the IEC60950-1 standard.
- Make sure you have a Kycon KPPX-4P connector.
- Make sure the cord you associate with the Kycon KPPX-4P connector fits your requirements. The choice of the cord is under your responsibility.

To connect the OSA20 to a 48 V DC power source:

1. Make sure the power switch is set to **O**.
2. On the rear panel, connect the Kycon KPPX-4P connector to the 48 V connector and make sure the five pins are connected.
3. On the rear panel, set the power switch to **I**.

Connecting a Light Source to the OSA20

You can connect any type of light source whose output power is in the range indicated in the technical specifications (see *Technical Specifications* on page 1).



CAUTION

- Make sure you use the appropriate connector type, corresponding to the one mounted on your OSA20 (see *Interfaces and Electrical* on page 3 for available models).
- Make sure optical connectors are perfectly clean. It is essential to achieve optimum system performance (see *Cleaning Optical Connectors* on page 139).

To connect a light source to the OSA20:

1. Remove the protective cap from the **Optical input** connector.



IMPORTANT

Keep protective caps on optical connectors when not in use.

2. Connect the light source to the optical input of the OSA20 with the appropriate patch cord corresponding to the connector type mounted on your product, as indicated on the connector's plate (see *Front Panel* on page 4).

Connecting a Mouse and Keyboard to the OSA20

To operate the OSA20, you can connect a USB mouse and keyboard to the USB-A 2.0 and USB-A 3.0 ports located on the front and right-side panels of the OSA20 (see *Product Overview* on page 4).

To connect mouse and keyboard:

Connect the USB mouse and keyboard to one of the available USB ports (you do not need to restart the OSA20).

- All operations available using the multi-touch screen are also accessible using the mouse and keyboard.
- The Windows keyboard shortcuts are deactivated.
- The default keyboard setting is QWERTY.

To configure your keyboard using the GUI:

The following procedure explains how to set the language layout corresponding to the keyboard you have connected. After connection, the default keyboard setting is QWERTY.

1. In the OSA20 home window, touch the **Settings** button.

The **Keyboard** area enables you to switch between QWERTY and AZERTY keyboard.

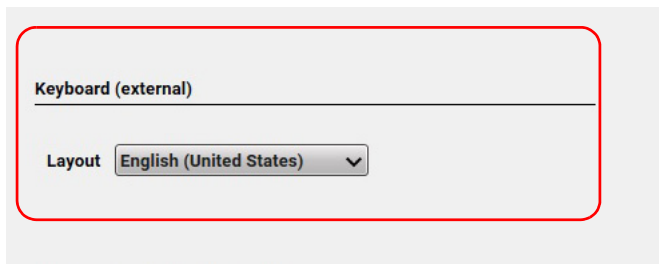

2. Select the appropriate keyboard in the **Layout** list:
 - French (France): AZERTY keyboard
 - English (United States): QWERTY keyboard
3. Touch the  button to go back to the OSA20 home window.

Sharing the OSA20 Display with an External Screen

You can connect an external screen to the OSA20 to share the display and control (you do not need to restart the OSA20).

Make sure the screen you want to connect to the OSA20 can connect to a VGA, DVI or HDMI port, and make sure you have the appropriate connection cable to connect your external screen.

To share the OSA20 display with an external screen:

- 1.** Connect your external screen to one of the available screen connectors located on the right-side panel of the OSA20 (see *Right-side Panel: Connectors* on page 6) with the appropriate cable.
- 2.** If the external screen is a touchscreen: connect it to the OSA20 with a USB-A cable to be able to operate the OSA20 with multi-touch gestures from the connected screen.
- 3.** In the OSA20 home window, touch the **Settings** button.

The **Settings** window appears. The screen you have connected is available in the **Screen** list. If not, touch the **Refresh** button to make it appear.

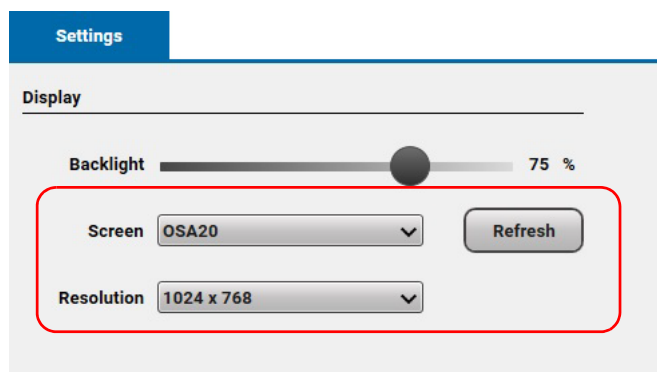

- 4.** In the **Display** area, select the screen on which you want to display the OSA20 graphical user interface (GUI):
 - **OSA20:** the GUI is only displayed on the OSA20 screen.
 - **External:** the GUI is only displayed on the external connected screen.
 - **OSA20 & External:** the GUI is displayed on the external connected screen and on the OSA20 screen.

The OSA20 display immediately appears on the external screen (if selected).

- 5.** Select the resolution of the screen.

The resolution immediately changes on the external screen.

Turning on the OSA20 and Accessing the Home Window

The home window enables you to access the wanted analysis mode and the main configuration settings of the OSA20.

Make sure the OSA20 is properly installed: see *Unpacking and Installing the OSA20* on page 19.

To display the OSA20 Home window:

- If the OSA20 is turned off:

On the front panel, press the  button.

After a few seconds, the button lights up. The startup procedure takes approximately 1 minute and 30 seconds.

Once started, the OSA20 home window appears.

- If the OSA20 is turned on and you have selected an analysis mode or a configuration window:

Touch the  button.



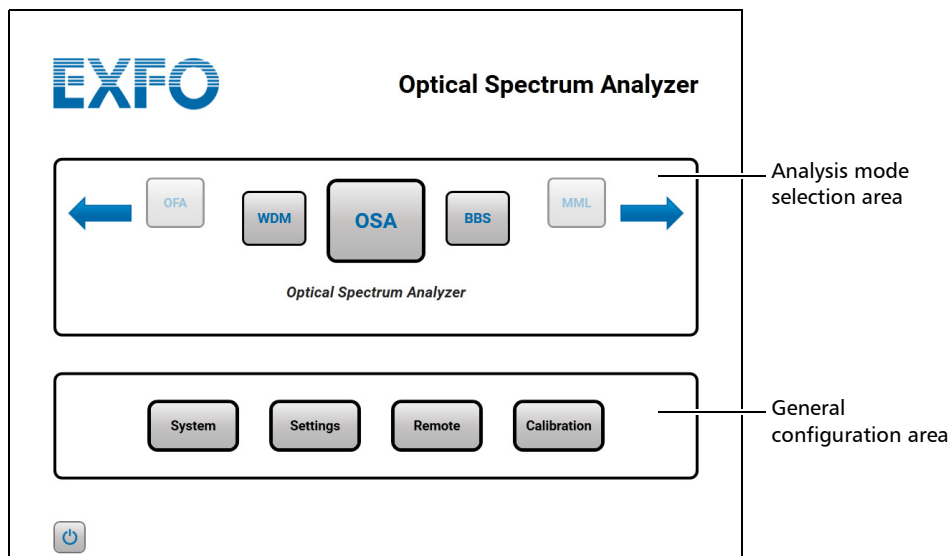

The OSA20 home window appears.



- Analysis mode selection area

Each analysis mode has its own traces and analysis tools. For more details, see section *Accessing an Analysis Mode* on page 33.

➤ General configuration area

Button	Description
	Provides information about the OSA20 and a customer support contact list. The More button gives access to additional information on the system and to remote assistance tools (see <i>Using Remote Assistance Tools</i> on page 148).
	Enables you to set the OSA20 general parameters.
	Enables you to set the remote control parameters of the OSA20. For more details, see <i>Using the OSA20 in Remote Control</i> on page 133.
	Opens the OSA20 user calibration application, which enables you to reference the monochromator to one of the acetylene absorption lines. For more details, see <i>Performing a User Calibration</i> on page 140.

Turning off the OSA20

The following procedure explains how to correctly turn the OSA20 off.





CAUTION

Never turn the OSA20 off by directly setting the power switch to **O**.

To turn the OSA20 off:

1. Do one of the following:

Touch the  button and in the home window, touch the  button.

OR

On the front panel, shortly press the  button.

A confirmation message appears.

2. Touch **Yes**.
The OSA20 stops.
3. On the rear panel, set the power switch to **O**.

Updating the OSA20 System Version

The OSA20 embedded software package is a .pkg file available on the EXFO website.

Updating the OSA20 system version does not affect calibration data nor user data.

The last software package (version 2.0.x and above) can only be installed on OSA20 embedding Windows 10 operating system (see the following procedures for details):

- ▶ Package versions 2.x are only compatible with OSA20s embedding Windows 10.
- ▶ Package versions 1.x are only compatible with OSA20s embedding Windows 7.

OSA20 with serial number starting with EO can be upgraded to Windows 10. If you want to migrate your OSA20 to Windows 10, please contact EXFO (see *Contacting the Technical Support Group* on page 149).

To check the operating system version installed on your OSA20:

1. In the OSA20 home window, touch the **System** button.
2. Touch the **More** button to access the system additional information.

The PC section indicates the operating system (OS) version installed on your OSA20: Windows 7 or Windows 10.

3. If your OSA20 embeds Windows 7:

3a. Verify if your OSA20 can be upgraded to Windows 10 by checking its serial number: in the OSA20 home window, touch the **System** button.

The System Information area display the OSA20 serial number. If it starts with EO, your OSA20 can be upgraded to Windows 10.

3b. To migrate your OSA20 to Windows 10, please contact EXFO.

To update the OSA20 system version:

1. Make sure that your OSA20 is compatible with the update package you want to install (see the above procedure):
 - ▶ Package versions 2.x are only compatible with OSA20s embedding Windows 10.
 - ▶ Package versions 1.x are only compatible with OSA20s embedding Windows 7.
2. From the EXFO website (www.EXFO.com/en/exfo-apps), download the OSA20 update package (compressed into a .zip file) and unzip it to a USB device, so that the necessary .pkg file is located at the USB device root.
3. Connect the USB device to one of the available USB ports on the front panel (see *Front Panel* on page 4).
4. Turn off the OSA20 (see *Turning off the OSA20* on page 27).
5. On the front panel, press the  button to turn on the OSA20.

The OSA20 automatically detects the .pkg file on the USB device and starts the update wizard.



CAUTION

To avoid serious system problems:

- Do not turn the OSA20 off during the update.
- Do not remove the USB device before the end of the upgrade process.

6. Follow the instructions displayed on screen to update the system version.

Once the update is finished, the OSA20 starts normally.

7. Safely remove the USB device as explained in *Connecting/Disconnecting USB Storage Devices* on page 127.

Updating the Operating System Version (Security Updates)

You should check for updates regularly to keep the OSA20 operating system version up to date for security reasons.

Updating the operating system may take a significant amount of time.

To update the operating system version:

- 1.** Make sure that your OSA20 is connected to the Internet with an Ethernet cable, on Ethernet port #2 (see *Right-side Panel: Connectors* on page 6).
- 2.** Turn on the OSA20 as explained in *Turning on the OSA20 and Accessing the Home Window* on page 26.
- 3.** In the OSA20 home window, touch the **Settings** button.

The **Operating System** area enables you to update the operating system.

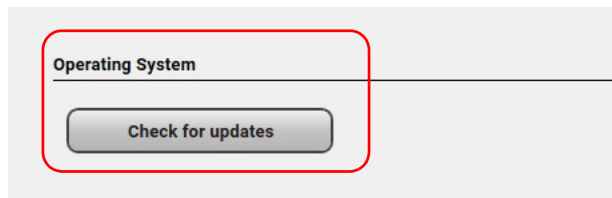

- 4.** Click the **Check for updates** button.

The OSA20 verifies if your system is up to date. This operation might take time. If updates are available, a message gives the list of available updates and prompts you to install them.

- 5.** Click the **Download, install and restart** button to install the update(s).

The OSA20 downloads and installs the updates, and then restarts automatically.

- 6.** Once the OSA20 has restarted: in the **Settings** window, click the **Check for updates** button again to make sure that all updates have been installed. If all updates have not been installed, perform steps 1 to 5 again to install all the available updates.

4 Setting Up Your OSA20

Setting the Screen Brightness

You can modify the GUI brightness as explained in the following procedure.

To modify the screen brightness:

1. In the OSA20 home window, touch the **Settings** button.

The **Backlight** cursor enables you to define the screen brightness.

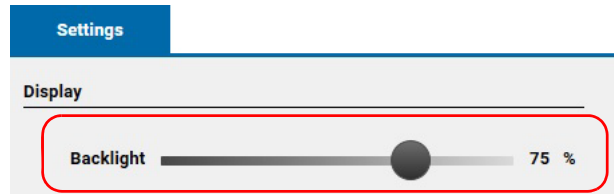

2. Slide the **Backlight** cursor to increase or decrease the brightness of the OSA20 screen.
3. Touch the  button to go back to the OSA20 home window.

Setting Spectral and Power Units

You can set the spectral and power units to use in measurements and analysis.

To set the units from the Settings window:

1. In the OSA20 home window, touch the **Settings** button.

The **Units** area enables you to set the spectral and power units of the OSA20.

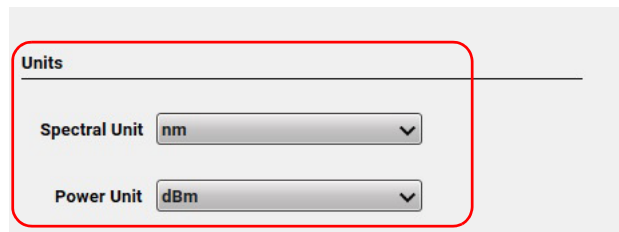

2. Touch the **Spectral Unit** and **Power Unit** lists to select the wanted units.
If **Power Unit** is set to mW, the minimum scale value is 0 mW in all cases, regardless the zoom factor.
3. Touch the  button to go back to the OSA20 home window.

To set the units from the Analysis mode window:

1. In the Analysis mode window, touch one of the following button to modify the spectral

or power units used for measurement and analysis:



2. To apply the change to the analysis results, restart the analysis.

Setting the Date and Time

The date and time set here will be used for all measurements.

Setting Up Your OSA20

Setting the Date and Time

To set the date and time:

1. In the OSA20 home window, touch the **Settings** button.

The **Date & Time** area enables you to set the date and time of the OSA20.

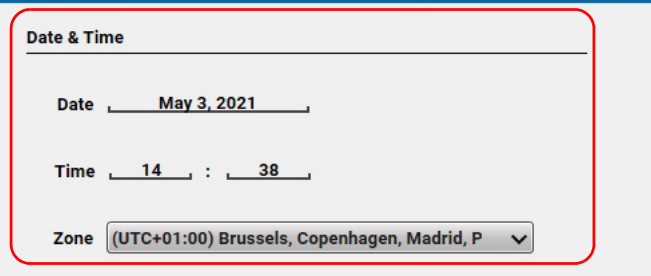

The screenshot shows the 'Date & Time' settings interface. At the top, there is a title 'Date & Time' followed by a horizontal line. Below the line are three input fields: 'Date' with the value 'May 3, 2021', 'Time' with the value '14 : 38', and 'Zone' with a dropdown menu showing '(UTC+01:00) Brussels, Copenhagen, Madrid, P'. A red rectangular box highlights the entire settings area.

2. Touch the **Date** and **Time** (hours and minutes) fields to enter date and time.
3. Select your time zone in the displayed **Zone** list.
4. Touch the  button to go back to the OSA20 home window.

Accessing an Analysis Mode

The OSA20 provides eight analysis modes. Each mode has its own available traces and analysis tools, which are adapted to the tested application.

The available analysis tools by analysis mode are detailed in *Analyzing Traces* on page 61.

➤ **OSA – Optical Spectrum Analyzer**

This analysis mode is the most open of all. It contains most of the analysis tools available in the OSA20 for the characterization of unknown or mixed sources.

➤ **BBS – Broadband Source**

This mode provides a series of analysis tools designed for the characterization of Broad Band Sources such as Semiconductor, Raman or Fibre Optical Amplifiers and superluminescent or Edge-Emitting LED.

➤ **MML – Multimode Laser**

This mode provides a series of analysis tools designed for the characterization of sources with a large spectral width and several emission peaks. These sources are also known as Multiple-Longitudinal Mode Lasers, for instance the Fabry-Perot laser diodes.

➤ **SML – Single Mode Laser**

This mode provides a series of analysis tools designed for the characterization of single mode lasers such as distributed feedback Bragg laser diodes and external cavity lasers.

➤ **WDM – Wavelength Division Multiplexing**

This mode provides a series of analysis tools designed for the characterization of WDM signals such as Coarse WDM, Dense WDM and ROADM.

➤ **OFA – Optical Fiber Amplifier**

This mode provides a series of analysis tools designed for the characterization of optical amplifiers such as Erbium Doped Fiber Amplifier (EDFA).

➤ **PCT – Passive Component Tester**

This mode provides a series of analysis tools specific to the characterization of passive components such as optical filters, isolators or fibers.

➤ **RLT – Recirculating Loop Transmission**

This analysis mode is a special version of WDM and is specifically designed for recirculating loop experiments.

In this mode, the acquisition is synchronized with the gated input signal (via the **TRIG IN** port); at each scan a controlled shift is applied in order to control the scan completion.

Setting Up Your OSA20

Accessing an Analysis Mode

The total scan time is widely linked to the gate signal period and its duty cycle.

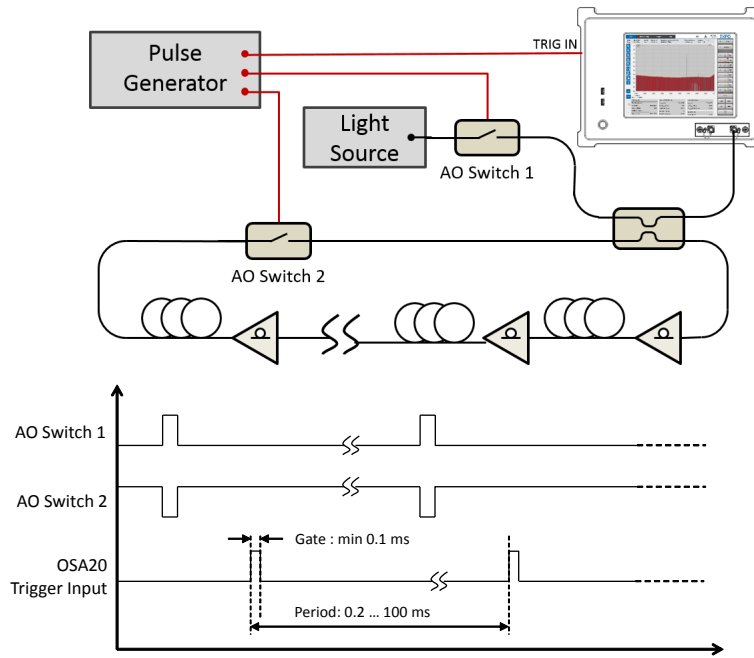

To access an analysis mode:

1. If you are using the OSA20 for the first time, calibrate it as explained in *Performing a User Calibration* on page 140 before accessing an analysis mode.
2. In the OSA20 home window, touch the right or left blue arrows to navigate to the wanted analysis mode.
3. Touch the button corresponding to the analysis mode you want to enter.

The analysis mode window appears.

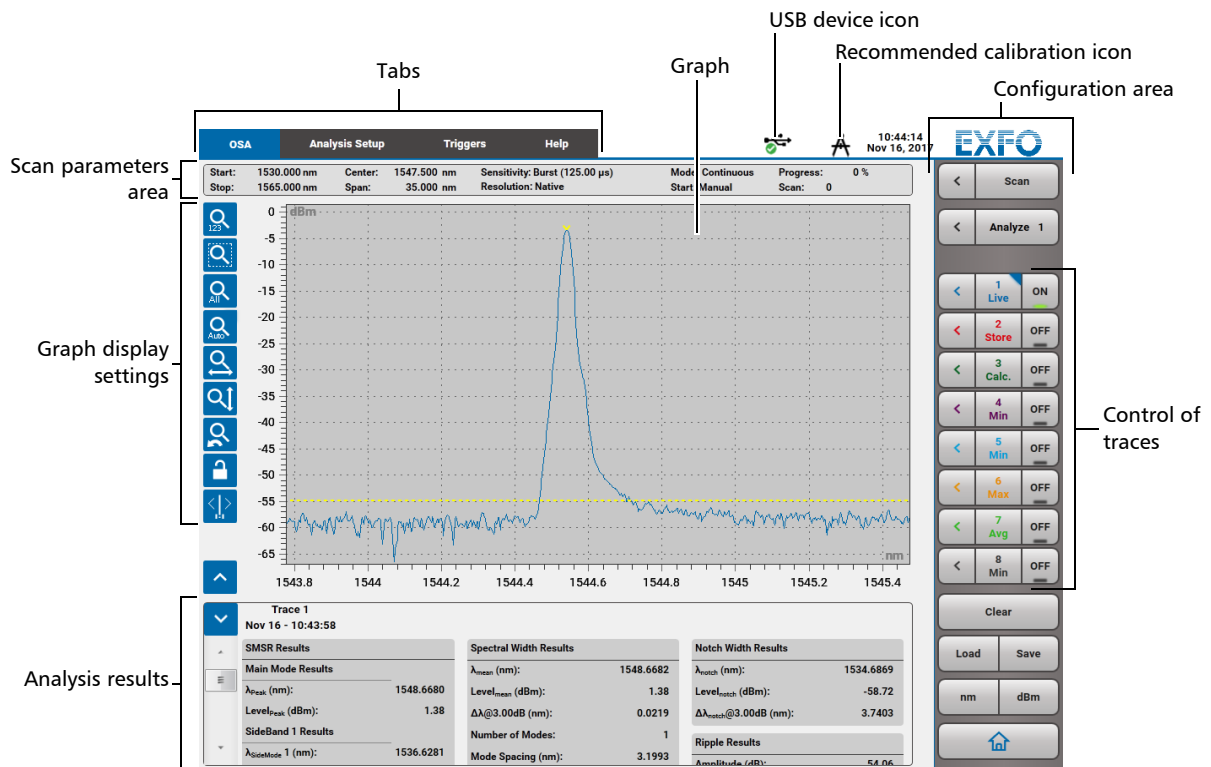

This window gives access to four tabs:

➤ **<Analysis mode> tab**

This tab displays the results of scan measurements (see *Performing Measurement Scans* on page 37 and *Configuring and Displaying Scan Traces* on page 49) and trace analysis (see *Analyzing Traces* on page 61).

➤ **Analysis Setup tab**

This tab gives access to the analysis tools that are available for the selected analysis mode, and enables you to modify the analysis parameters: see *Analyzing Traces* on page 61.

➤ **Triggers tab**

This tab enables you to define the trigger IN and OUT parameters: see *Triggering the Optical Spectrum Acquisition* on page 46 (trigger IN) and *Generating Output Trigger Signals* on page 47 (trigger OUT).

➤ **Help tab**

This tab displays the *OSA20 User Guide*. Using the **Help** tab during a scan may slow it down.

5 Performing Measurement Scans

You can adjust the optical spectrum acquisition with the measurement parameters available from the analysis mode window.

The spectrum acquisition is performed on all available traces, according to the type of trace set.



IMPORTANT

If you are using the OSA20 for the first time, you must calibrate it before performing scan measurements, as explained in *Performing a User Calibration* on page 140.

Defining the Scan Parameters

You can access the scan parameters from the analysis mode window.

Defining the Sweep Parameters

The **Scan** menu enables you to define the sweep range, resolution and sensitivity you want to apply to the acquisition. See the following procedure for details.

To set the sweep parameters:

1. Enter the wanted analysis mode (see *Accessing an Analysis Mode* on page 33).
2. In the **<Analysis Mode>** tab, touch the  button located at the left of the **Scan** button.

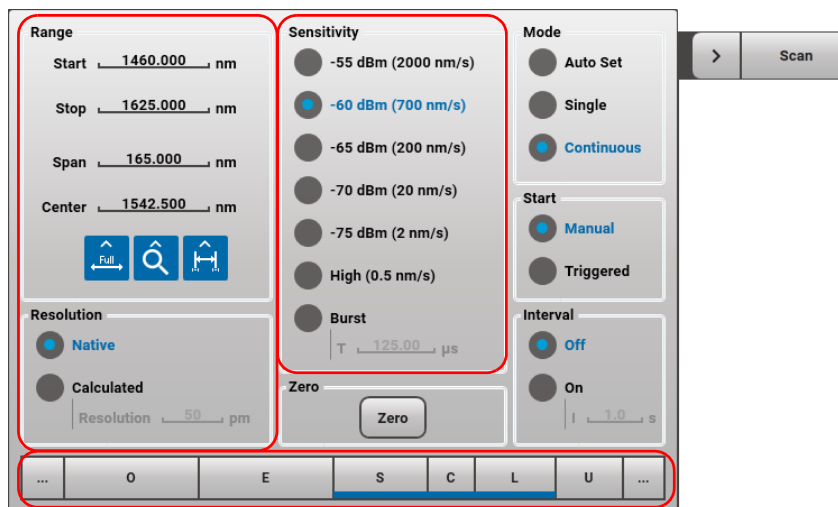





3. In the **Scan** menu, set the sweep range by using one of the available range parameters described in the following table (to modify a numeric value, touch the wanted value to display a numeric keypad):

Setting	Description
Start/Stop	Wavelength/frequency overall scanning range. The max/min wavelength or frequency range is defined in <i>Technical Specifications</i> on page 1).

Performing Measurement Scans

Defining the Scan Parameters

Setting	Description
Span/Center	Wavelength scanning span. Minimum span value: 0.5 nm. In THz, limits are also 0.5 nm span (it is not linear in THz).
	Sets the scanning range to the maximum possible wavelength range (see <i>Technical Specifications</i> on page 1).
	Sets the scanning range to the zoom parameters displayed on graph.
	Sets the scanning range to the limits specified by the positions of A and B markers (see <i>Performing Manual Measurements With Markers</i> on page 58).
O/E/S/C/L/U buttons	<p>Wavelength scanning range, defined by ITU band selection. The blue line pictures the selected bandwidth.</p> <ul style="list-style-type: none"> ➤ To select a single band, touch the corresponding button twice. ➤ To select several bands, touch the corresponding adjacent buttons one after another. ➤ To modify the boundaries of a band, long press (or right-click) the corresponding band button. The numeric keypad enables you to enter the upper limit value of the selected band (no more than ± 10 nm shift from the original ITU band) <div style="text-align: center;">  </div> <p>Selecting a band modifies the values defined in the Range area.</p>

4. Set the wanted resolution and sensitivity using the instructions given in the following table:

Setting	Description
Resolution	<ul style="list-style-type: none"> ➤ Native (default value) The spectral resolution is automatically set to the OSA20's monochromator factory-calibrated optical resolution bandwidth (see <i>Technical Specifications</i> on page 1). ➤ Calculated The spectral resolution is set to the value you specify in the value field. In this case, the resolution is constant on the whole wavelength/frequency range, whatever the unit set (THz or nm) selected in the Settings window (see <i>Setting Spectral and Power Units</i> on page 31). Touch the value field to specify the wanted resolution value. Possible value: from 50 to 2000 pm or from 6 to 400 GHz

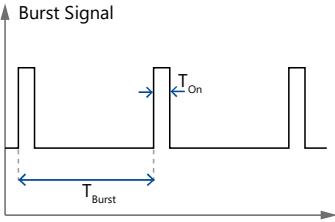
Setting	Description
Sensitivity	<p>Detection sensitivity corresponding to estimated noise around 1575 nm (typ.), which is related to the scanning speed (specified in brackets in the menu).</p> <p>To reduce the noise level, you can use the Average or Roll Average trace types (see p. 50).</p> <p>The fastest total scan time is not necessarily the fastest scan speed so it is recommended to experiment with different sensitivities.</p> <p>In RLT mode, the sensitivity is automatically set to -60 dBm and cannot be modified.</p> <p>➤ Burst: this sensitivity is adapted to burst signals and dedicated to GPON measurements. It optimizes the detection of optical power during the burst signal by returning the maximum detected level during the burst period (T_{Burst}):</p>  <p>If several pulses are detected during the T_{Burst} period, only the maximum detected level is recorded.</p> <p>The duty cycle $\eta = \frac{T_{On}}{T_{Burst}}$ of the signal must be in the range 2–100%.</p> <p>Enter the period of the signal T_{Burst} in the T parameter field. It must be between 10 and 2001 μs.</p> <p>The scan speed depends on the T value (the typical speed corresponding sensitivity is -75 dBm to High): at low T value, the scan speed is faster and it decreases as the value increases.</p>

5. Touch the  button or anywhere on the screen outside the menu to exit.

Defining the General Scan Settings

You can define the scan mode and sweep interval in case of continuous mode, as explained in the following procedure.

To define the general scan parameters:

1. In the <Analysis Mode> tab, touch the  button located to the left of the **Scan** button.

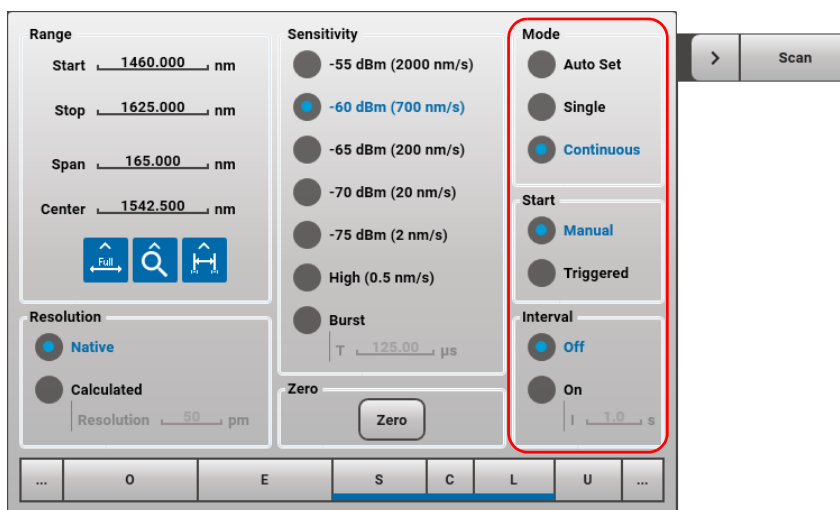

2. In the **Scan** menu, set the scan mode by using the instructions given in the following table:

Setting	Description
Mode	<p>➤ Auto Set</p> <p>The OSA20 performs an initial scan of the signal and then automatically defines the range and sensitivity:</p> <ul style="list-style-type: none"> - It zooms on the interesting spectral region: twice the spectral width detected at 20 dB of the main peak. - It sets the sensitivity at the last selected sensitivity. - It switches to Continuous scan mode.
	<p>➤ Single</p> <p>The OSA20 performs a single scan of the optical spectrum (according to the defined trace types) and then stops.</p> <p>If a trace is set to <i>Roll Average: n</i>, the OSA20 performs <i>n</i> scans to be able to calculate the average value and then stops.</p>
	<p>➤ Continuous</p> <p>The OSA20 performs a continuous series of scans of the optical spectrum in accordance with the interval set in the Interval parameter (see Manually Starting/Stopping the Optical Spectrum Acquisition below), until you touch the Stop button.</p>

Setting	Description
Interval	<p>This parameters applies to Continuous scanning mode, and in Single scanning mode, if a trace is set to Average type (see <i>Setting Trace Types</i> on page 50).</p> <ul style="list-style-type: none"> ➤ Off The OSA20 performs all scans successively with minimum pause between scans. ➤ On The OSA20 observes the period of time specified in the I field before starting the next successive scan. I: period of time between the beginning of two successive scans. If the interval set is greater than the scan time, the OSA20 waits before the next scan. If the period of time is lower than the scan time, the OSA20 immediately performs the next scan.

3. In the **Scan** menu, set the start mode by using the instructions given in the following table:

Setting	Description
Gate Acquisition (RLT mode only)	<p>Polarity of the gate signal provided to the TRIG IN BNC connector (see RLT – Recirculating Loop Transmission on page 33).</p> <ul style="list-style-type: none"> ➤ High: the acquisition is performed when the signal is high. ➤ Low: the acquisition is performed when the signal is low. <p>Timing requirement of the gate signal:</p> <ul style="list-style-type: none"> ➤ Gate period: between 0.2 and 100 ms ➤ Gate minimum width: 0.1 ms
Start	<ul style="list-style-type: none"> ➤ Manual You perform the optical spectrum acquisition manually, by following the procedure detailed in <i>Manually Starting/Stopping the Optical Spectrum Acquisition</i> on page 45. ➤ Triggered The OSA20 waits for the defined trigger signal to perform the optical spectrum acquisition. For more details, see <i>Triggering the Optical Spectrum Acquisition</i> on page 46.

Defining the Power Offset

You can apply a compensation value to the detected power upon acquisition, from -2.00 dB to 2.00 dB.

To apply a power offset:

1. In the OSA20 home window, touch the **Settings** button.

The **Offset** area enables you to apply a power offset on the detected power upon acquisition.

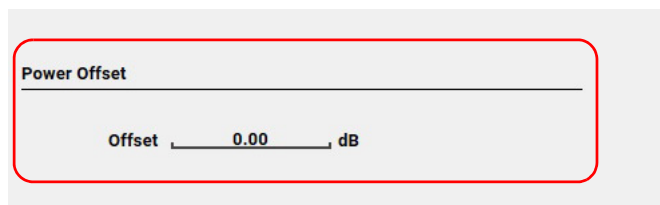

2. Touch the Offset field to enter the wanted power offset.
3. Touch the  button to go back to the OSA20 home window.

Zeroing the Dark Current

The zeroing function uses a shutter to perform a dark current measurement on the detection system. It usually takes 2 to 5 seconds.

The OSA20 can automatically perform zeroing while scanning, or you can perform it manually as explained in the following sections:

- *Automatically Zeroing the Dark Current* on page 43
- *Manually Zeroing the Dark Current* on page 44

Automatically Zeroing the Dark Current

In the **Settings** window, the **Auto-Zero** function enables you to periodically perform a dark current measurement.

For best power accuracy measurements, we recommend to leave this function activated during OSA20 operation.

To set the Auto Zero function:

1. In the OSA20 home window, touch the **Settings** button.

The **Dark Current Cancellation (Zero)** area enables you to set the auto-zero function of the OSA20.

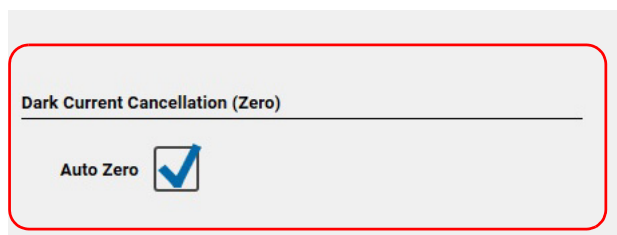

2. Select the **Auto zero** check box to periodically remove the dark current from the measurements, as follows:
 - In continuous scanning mode, a zeroing is performed every 5 min over the first 3 hours of operation, and every 10 min after that.
 - In single scanning mode, a zeroing is performed before the scan at 5 min intervals in the first 3 hours of operation, and at 10 min intervals after that.
 - A zeroing is forced at the first scan whenever the sensitivity is changed from -55/-60/-65 to -70/-75/HIGH/Burst, or vice versa.
 - No zeroing is performed during idle time (i.e. if no scan is performed) unless manually activated.
3. Touch the  button to go back to the OSA20 home window.

Performing Measurement Scans

Zeroing the Dark Current

To cancel the Auto Zero function:

1. In the OSA20 home window, touch the **Settings** button.

The **Dark Current Cancellation (Zero)** area enables you to cancel the auto-zero function.

2. Clear the **Auto zero** check box.

The dark current is never set to zero automatically. You can perform it manually using the **Scan** menu (see *Manually Zeroing the Dark Current* on page 44).

This setting resets to the default activated position at startup to avoid erroneous measurements during instrument warm-up.

3. Touch the  button to go back to the OSA20 home window.

Manually Zeroing the Dark Current

In the **Scan** menu, the **Zero** button enables you to perform a dark current measurement and then apply the corresponding offset to the OSA20 detection system.

To zero the dark current:

1. In the **<Analysis Mode>** tab, touch the  button located to the left of the **Scan** button.

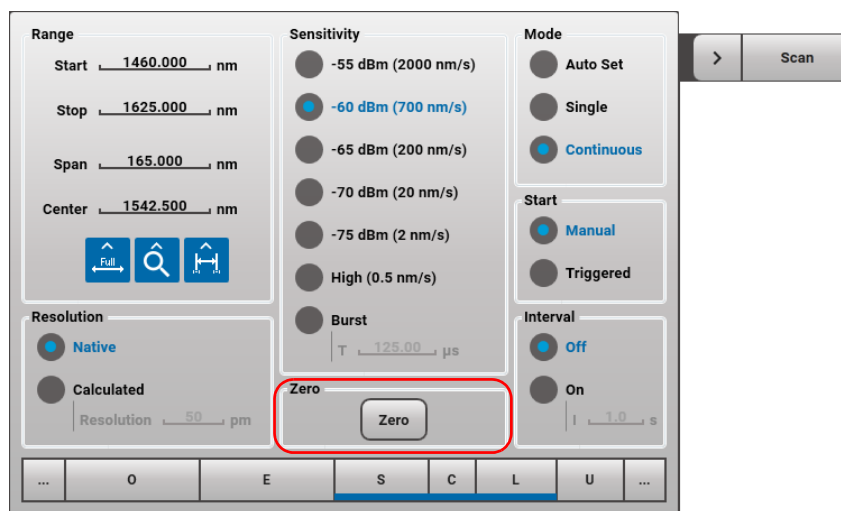

2. In the **Scan** menu, touch the **Zero** button.

The dark current is measured and the corresponding offset is applied to the OSA20 detection system.

If the **Auto Zero** check-box in the **Settings** window is cleared (see *Automatically Zeroing the Dark Current* on page 43), a notification appears below the button.

Manually Starting/Stopping the Optical Spectrum Acquisition

The optical spectrum acquisition is performed according to the scanning parameters defined in *Defining the Scan Parameters* on page 37, on traces that are available for scan.

Scanning operation has no effect on traces set to **Store** or **None** types (see *Setting Trace Types* on page 50).

To start the acquisition:

1. In the **Scan** menu, set the **Start** parameter to **Manual**.
2. Make sure the type of traces to scan is not set to **Store** or **None**.
3. Touch the **Scan** button.

The **Scan** button label displays **Stop** and the acquisition starts using the selected parameters (see *Defining the Scan Parameters* on page 37).

In the scan parameters area above the graph, you can follow the scan progress (in percent) and number of scans. In RLT mode, **Progress** indicates the completion of the overall acquisition (and not only the completion of the scan).

If the **Single** scanning mode is selected, the acquisition stops automatically.

If the **Auto Zero** check box is selected (see *Automatically Zeroing the Dark Current* on page 43) the button displays **Zeroing** periodically.

To stop the acquisition:

To stop the acquisition at the end of the scan in progress, touch the **Stop** button.

- The button label switches to **Abort** until the acquisition stops (at the end of the current scan).
- If you touch the **Abort** button while the acquisition is stopping, the acquisition does not finish the spectrum scan and stops as quickly as possible.

Triggering the Optical Spectrum Acquisition

The **TRIG IN** BNC connector (see *Right-side Panel: Connectors* on page 6) allows you to externally trigger the optical spectrum acquisition, as explained in the following procedure.

To trigger the acquisition:

1. At the top of the screen, touch the **Triggers** tab.

The trigger configuration screen appears.

2. In the **Trigger In** area, set the wanted parameters for the input trigger, according to the instructions given in the following table.

Parameter	Description
Auto Rearm	<ul style="list-style-type: none"> ➤ <input checked="" type="checkbox"/> (default): the system is automatically rearmed after each triggered scan, so that it is ready for the next triggered scan (Single scanning mode). In Continuous scanning mode, the scan is triggered once and then runs on continuous. If the trace is set to Roll Average (see Roll Average on page 50) in Single scanning mode, the scan is triggered to perform the number of scan set for the "average" and then rearmed. ➤ <input type="checkbox"/>: the system is not rearmed after a triggered scan. In this case: In Single scanning mode, you can only trigger one scan. In Continuous scanning mode, the scan is triggered once and then runs on continuous.
Slope	<ul style="list-style-type: none"> ➤ Positive: the scan is performed when the received signal rises. ➤ Negative: the scan is performed when the received signal falls. ➤ Either: the scan is performed when the received signal rises or when it falls.

3. Connect the external trigger to the **TRIG IN** BNC connector.

4. Touch the  button located to the left of the **Scan** button to display the scan menu.

5. Select the wanted scanning parameters (see *Defining the Scan Parameters* on page 37), and set the **Start** parameter to **Triggered**.

The OSA20 will scan the optical spectrum according to the parameters set in the scan menu and in the **Triggers** tab.

Generating Output Trigger Signals

The **TRIG OUT** BNC connector (see *Right-side Panel: Connectors* on page 6) allows you to output trigger signals when the OSA20 performs a scan, as explained in the following procedure.

To generate an output trigger signal:

1. Touch the **Triggers** tab.

The trigger configuration screen appears.

2. In the **Trigger Out** area, set the wanted parameters for the output trigger, according to the instructions given in the following table.

Parameter	Description
On Span	<ul style="list-style-type: none"> ▶ <input checked="" type="checkbox"/> (default): the OSA20 outputs a trigger signal when it starts and stops scanning the wavelength range defined in the scan menu. ▶ <input type="checkbox"/>: the OSA20 outputs a trigger signal when it starts and stops scanning the wavelength range defined in the Start/Stop fields.
Inverted Logic	<ul style="list-style-type: none"> ▶ <input checked="" type="checkbox"/>: the OSA20 outputs a low level signal when it scans. ▶ <input type="checkbox"/> (default): the OSA20 outputs a high level signal when it scans.

3. Connect the external instrument to the **TRIG OUT** BNC connector.

4. Touch the  button located to the left of the **Scan** button and select the wanted scanning parameters (see *Defining the Scan Parameters* on page 37)

The scanning operation will trigger an output signal according to the selected parameters.

6 Configuring and Displaying Scan Traces

Operating Scan Traces

The number and type of available traces depends on the selected analysis mode. It is adapted to the analysis mode needs:

- In **OSA**, **WDM**, **RLT**, **SML**, **MML** and **BBS** modes, eight traces are available. They are numbered from 1 to 8 and can be set to various types so that it represents the wanted calculation or value.
- In **OFA** mode, four traces are available:
 - **IN** and **OUT** traces for acquisition
 - **ASE in** and **ASE out** traces, calculated from the analysis performed on traces **IN** and **OUT**
- In **PCT** mode, five traces are available:
 - **REF** trace (reference trace) and **DUT** (device under test) traces for acquisition
 - **TRANS** trace (for transfer function), which is the log calculation of the **DUT** trace - **REF** trace
 - **MSK HI** (high mask) and **MSK LO** (low mask) for acquisition of high and low traces that make the mask. For more detail on mask setup, see *Setting Up Mask Test Analysis* on page 125.

Each trace is represented by a different color.

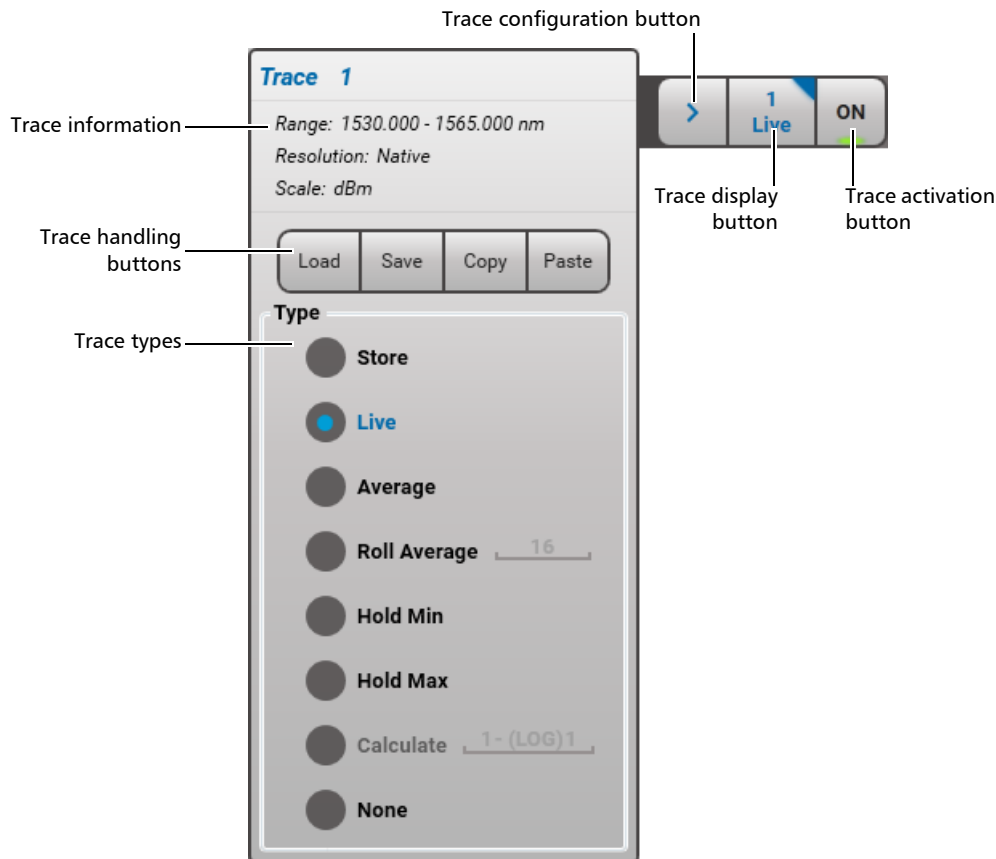

Setting Trace Types

You can set a different type for each available trace, so that it represents the wanted calculation or value, as explained in the following procedure.

To define a trace type:

1. In the **<Analysis Mode>** tab, touch the  button located to the left of the wanted trace button.

The trace menu appears.

2. Set the wanted parameters for the selected trace, according to the instructions given in the following table.

Trace Type	Description
Store	The trace is frozen. It won't be modified by next scans.
Live	The trace pictures the next scan.
Average	The trace pictures the average of all scans performed from the first scan. This trace type is useful to reduce the noise level if necessary.
Roll Average	The trace pictures the rolling average of a defined number of previous scans. This trace type is useful to reduce the noise level if necessary. To set the number of scans to take into account to calculate the average, touch the Roll Average numeric field. Maximum value: 100 scans
Hold Min	The trace pictures the minimum scanned values point to point.
Hold Max	The trace pictures the maximum scanned values point to point.
Calculate	<p>The trace pictures a calculation from two other defined traces. The traces used for calculation cannot have a number greater than or equal to the current trace (e.g. Trace #4 can only perform a calculation from Trace #1; Trace #2 and Trace #3). To define the calculation, touch the Calculate field:</p> <p>Select the two traces from which you want to make the calculation and the wanted linear or logarithmic operator:</p> <div data-bbox="316 1469 539 1639" data-label="Image"> </div> <ul style="list-style-type: none"> ➤ + (LIN): Addition of both traces in mW, leading to a result in dBm/mW. ➤ - (LIN): Subtraction of two traces in mW, leading to a result in dBm/mW. ➤ - (LOG): Subtraction of two traces expressed in dBm, leading to a result in dB/ratio.
None	Clears the trace content and deactivates the trace.

Trace Type	Description
ASE in/out	OFA mode only. Analyzed trace that cannot be modified. The trace pictures the ASE, calculated from the analysis performed on traces IN and OUT .
TRANS	PCT mode only. Calculated transfer function trace that cannot be modified. The trace pictures the log calculation of the DUT trace - REF trace.

3. Touch the  button or anywhere on the screen outside the menu to exit.

Displaying/Hiding Traces

By default, all traces are displayed on graph (the trace display button set to ON).

To display a trace:

To display a trace, touch the **OFF** button located to the right of the trace number.

The button label changes to **ON** and the trace appears on the graph (only if there is content to display).

To hide a trace:

To hide a trace, touch the **ON** button located to the right of the trace number.

The button label changes to **OFF** and the trace disappears from the graph.

Activating Traces

The trace activation button (see *Operating Scan Traces* on page 49) displays the trace number and type, and the corner flag spots the trace displayed in the foreground.

To bring to front a displayed trace:

To bring to front a displayed trace, touch the trace activation button

A flag appears on the corner of the trace button.

Deleting Traces

You can delete all trace content and analysis results, except for Store type traces.

To delete trace data from the graph and all analysis results:

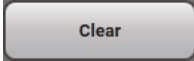

In the Analysis mode window, touch the  button.

Copying/Pasting Trace Data

The trace menu enables you to quickly copy/paste traces from one trace number to another (even from one analysis mode to another), with command buttons.

Restriction: you cannot paste a trace to an analyzed trace (i.e. traces **ASE in/out** in OFA mode and **TRANS** trace type in PCT mode).

To copy and paste a trace:

1. In the **<Analysis Mode>** tab, touch the  button located to the left of the trace number you want to copy and touch the **Copy** button.
2. Touch the  button located to the left of the trace number on which you want to paste the copied trace and touch the **Paste** button.

The trace type is automatically set to **Store**.

Saving/Loading Traces

Traces can be saved in .csv, .xcsv (decimated data) or .tra (OSA20 specific format) formats on the following media:

- The internal OSA20 drive (*D:\ (USER)*).
- An external USB key or hard drive.

Restriction: you cannot load a trace in place of an analyzed trace (i.e. traces **ASE in/out** in OFA mode and **TRANS** trace type in PCT mode).

To save a trace:

1. If necessary, connect to one of the USB ports the device on which you want to save the trace.
2. In the **<Analysis Mode>** tab, touch the  button located to the left of the wanted **Trace** button and touch the **Save** button.

The Save window appears. All connected drives are displayed.

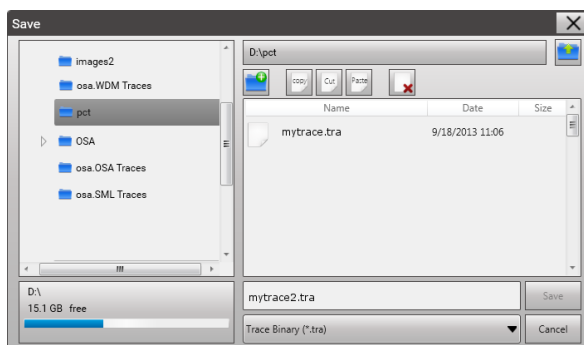

3. Touch the wanted drive and folder.

4. If you want to create a new folder: touch the  button and type a name for the folder (using the on-screen keyboard or a normal keyboard if connected to the OSA20) and touch the **Create** button.
5. Type a name for the trace: touch the text box at the left of the **Save** button to display the keyboard.
6. Select a format for the trace:
 - **.tra**: binary OSA20-specific format (smaller size than .csv format).
 - **.csv**: ASCII file for export in Excel or similar program:

Trace data is saved according to the original sampling resolution (1 point every 2 pm).

The data unit in the file is the unit set in the **Settings** window (see *Setting Spectral and Power Units* on page 31).
 - **.xcsv**: ASCII file for export in Excel or similar program.

Trace data is saved with a reduced number of data points, based on the optical sampling resolution in use (set in the scan parameters, see **Resolution** setting in *Defining the Scan Parameters* on page 37) and according to the following formula:

$$\text{Sampling} = \frac{2}{20} \times \langle \text{optical resolution} \rangle$$

For example, if the resolution is set to 100 pm, the sampling resolution will be 1 point every 10 pm.



IMPORTANT

If you load this type of trace file on the OSA20, missing points are generated on the graph by interpolation.

7. Touch the **Save** button.

A confirmation message appears.

The .csv ASCII file contains a header providing information about the trace acquisition conditions.

Example header of a .csv trace file:

```
EXFO OSA20
Format,1.2
S/N, YO0000001
Start,1530.000,nm
Sampling,0.002,nm
Resolution,0.0186,nm,Native
Sensitivity,-55dBm
Type,Live
Unit,nm,dBm
Length,17501
Wavelength;Power
1530.000;-100.000
```

Configuring and Displaying Scan Traces

Operating Scan Traces

1530.002;-100.000
1530.004;-100.000
1530.006;-100.000
1530.008;-100.000
1530.010;-100.000...

To load a trace:

1. If necessary, connect to one of the USB ports the device from which you want to load the trace.

2. In the **<Analysis Mode>** tab, touch the  button located to the left of the **Trace** button where you want to load the trace and touch the **Load** button.

The **Open** window appears. All connected drives are displayed, with the available files in the selected format.

3. Touch the file format list bar located below the filename field to select the format of the file you want to load.
4. Touch the wanted drive and folder and select the trace file you want to load.
5. Touch **Open**.

The trace is loaded in place of the selected trace and appears on the graph display. The trace type is automatically set to **Store**.

Handling Traces Files

You can access the OSA20 internal drive or an external hard drive connected to the OSA20 to handle the saved trace files. You can move trace files from one location to another, for example to copy a trace file saved on the internal drive to an external USB device. You can also delete files you have previously saved on the internal drive.

To delete a trace file:

1. If necessary, connect to one of the USB ports the device from which you want to delete the trace.

2. In the **<Analysis Mode>** tab, touch the  button located to the left of the wanted **Trace** button and touch the **Save** or **Load** button.

The Save or Open window appears.

3. Touch the wanted drive and folder.
4. Touch the file format list bar located below the filename field to select the format of the file you want to delete.

5. Select the trace you want to delete and touch the  button.



The trace is deleted from the drive.

To copy/Cut-Paste a trace file:

1. If necessary, connect to one of the USB ports the device on which you want to copy/cut or paste the trace.

2. In the **<Analysis Mode>** tab, touch the  button located to the left of the wanted **Trace** button and touch the **Save** or **Load** button.

The Save or Open window appears.

3. Select the trace you want to copy or cut and touch the button corresponding to the action you want to perform:  or  button.

4. Select the drive and folder in which you want to paste the file and touch the  button.

Adjusting the Graph Display

Adjusting the Scale of the Graph

Zoom commands enable you to adapt the scale of the graph to your needs.

You can activate the zoom function by using multi-touch screen gestures or zoom command buttons.





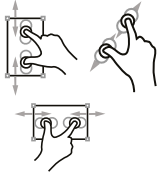
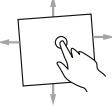
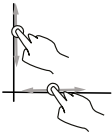
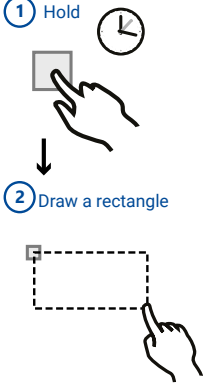
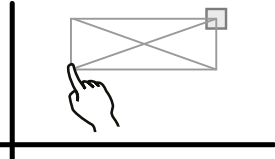

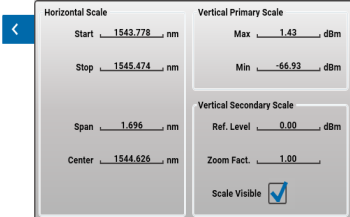

To adjust the graph display using multi-touch screen gestures:

To adjust the graph display, use the gestures described in the following table:

Gesture	Description
	<p>To zoom in or out, pinch two fingers together or move them apart. Maximum vertical zoom: 1 dBm</p> <p>If Power Unit is set to mW (see <i>Setting Spectral and Power Units</i> on page 31), the minimum scale value is 0 mW in all cases, regardless the zoom factor.</p>
	<p>To move in the graph, drag your finger across the screen.</p>
	<p>To browse the scale, drag your finger across the horizontal or vertical scale.</p> <p>If Power Unit is set to mW (see <i>Setting Spectral and Power Units</i> on page 31), the minimum scale value is 0 mW in all cases, regardless the zoom factor.</p>
 <p>1 Hold</p> <p>2 Draw a rectangle</p>	<p>To select the exact region of the spectrum that you want to display, hold your finger on the graph until a complete rectangle appears and draw a rectangle by dragging your finger across the graph on the region you want to zoom in (from left to right).</p>  <p>If you draw a rectangle from right to left, it cancels the last rectangle selection you have made.</p>

To adjust the graph display using zoom commands:

To adjust the graph display using zoom command, touch the wanted button located in the graph display settings area.

Button	Description
	<p>Opens a menu that enables you to specify the following scales:</p> <ul style="list-style-type: none"> ➤ Horizontal wavelength/frequency scale ➤ Vertical power scale. ➤ In case of Calculate trace: vertical secondary scale (in dB) appearing on the right on the graph <p>Touch a numeric value to modify it:</p> <p>Ref. Level: value of the primary scale that you want to match to the 0 level on the secondary scale.</p> <p>Zoom Fact.: zoom factor compared to the one used on the primary scale..</p> 
	<p>Enables you to select the exact region of the spectrum that you want to display:</p> <ol style="list-style-type: none"> 1. Touch the button to activate the rectangle zoom. The button icon becomes black. To deactivate the rectangle zoom, touch the button again. 2. Drag your finger across the graph to draw a rectangle corresponding to the region you want to zoom in. The rectangle zoom is automatically deactivated.
	<p>Automatically sets the display to the maximum wavelength and power range (defined in the technical specifications, see <i>Technical Specifications</i> on page 1).</p>
	<p>Automatically zooms on the interesting area of the spectrum: twice the spectral width detected at 20 dB of the main peak.</p> <p>The colored flag on the corner of the button indicates the color of the trace on which the zoom applies.</p>
	<p>Fits the wavelength range to the total range covered by all displayed traces.</p>
	<p>Fits the power range to the to the total range covered by all displayed traces.</p>
	<p>Undoes the last zoom action.</p>
	<p>Disables/Enables all multi-touch screen gestures on the graph.</p>



Performing Manual Measurements With Markers

Four markers are available:

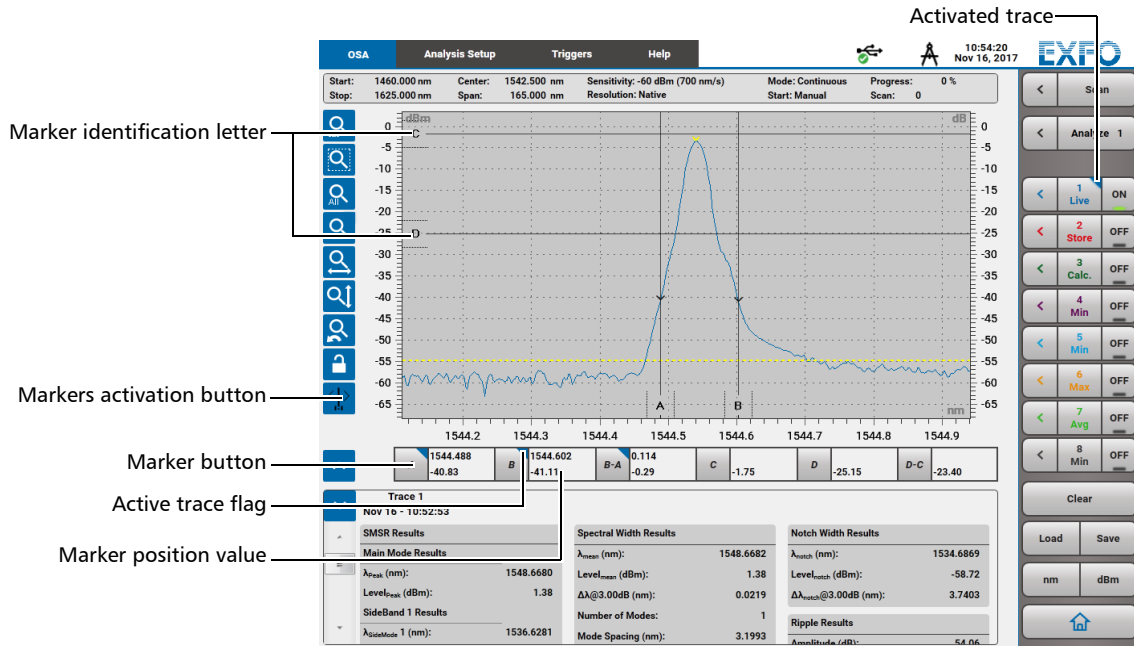





- Two vertical markers (A and B): associated with the displayed trace, to indicate the detected power at the wavelength on which they are positioned.
- Two horizontal markers (C and D) to indicate the optical power.



To manually measure a trace:

1. Activate the trace on which you want to position markers by touching the corresponding trace activation button (see *Operating Scan Traces* on page 49).
A colored flag appears on the corner of the activation button, indicating that the trace is brought to front and activated.
2. Touch the  button to display markers.
The button icon turns black, the markers appear on the graph, and their corresponding values on a line below the graph.
3. Place the markers at the wanted position on the graph using one of the following methods:
 - On the graph, touch the letter corresponding to the marker you want to move and slide it to the wanted position.
To make it easier to move markers without moving the graph, you can lock the graph by clicking the  button.

- Below the graph, touch the button corresponding to the marker letter you want to set and use the following commands to position the marker more precisely:

Button	Description
 	Moves the selected marker two picometers to the right or left direction. A long press on the right or left arrow button speeds up the move.
 	Moves the selected marker 200 pm to the right or left direction. A long press on the right or left arrow button speeds up the move.
	Opens a numeric keypad allowing you to type the exact marker position value (wavelength value or power value).
	Automatically places the selected marker to the center of the graph.

4. To hide markers, touch the  button.

The marker positions are kept in memory.

7 Analyzing Traces

The analysis consists of tools aimed at studying special aspects of the displayed spectrum. This allows a low interdependence of analysis results.

A tool can be used repeatedly to calculate several optical characteristics.

The following table gives an overview of the tools available for each analysis mode.





























This icon means that the analysis tool is available for the analysis mode and can be modified: you can modify the analysis parameters, and view the corresponding results.



This icon means that the analysis tool is available for the analysis mode and cannot be modified: the analysis is performed automatically according to preset parameters, and you can view the results.

Analysis Mode / Analysis Tool	OSA	BBS	MML	SML	WDM	OFA	PCT	RLT	Related section
Peak Trough Search									Setting Up Peaks and Troughs Search on page 66
Component Selector									Selecting the Component Under Test (PCT Mode) on page 69
Channel Detection									Setting Up Channel Detection on page 70
Spectral Width									Setting Up Spectral Width Analysis on page 76
Spectral Width 1 Spectral Width 2 Spectral Width 3									Setting Up Spectral Width Analysis on page 76
XXdB Width									Setting Up XXdB Width Analysis on page 81
Mean wavelength/ Frequency									Setting Up Mean Wavelength/Frequency Analysis on page 84
Peak wavelength/ frequency									Analyzing Peak Wavelength/Frequency Results on page 85
Central wavelength and Sigma value									Analyzing Central Wavelength and Sigma Value Results on page 86
FWHM									Analyzing FWHM Results on page 87

Analysis Mode Analysis Tool	OSA	BBS	MML	SML	WDM	OFA	PCT	RLT	Related section
Side Modes Spacing									<i>Analyzing Side Modes Spacing Results on page 88</i>
Notch Width									<i>Setting Up Notch Width Analysis on page 89</i>
Notch Width 1 Notch Width 2 Notch Width 3									<i>Setting Up Notch Width Analysis on page 89</i>
Level Check									<i>Setting Up Level Check Analysis on page 92</i>
SMSR									<i>Setting Up Level Check Analysis on page 92</i>
OSNR									<i>Setting Up OSNR Analysis on page 97</i>
Ripple									<i>Setting Up Ripple Analysis on page 103</i>
Optical Power									<i>Setting Up Optical Power Analysis on page 105</i>
Loss Measurement									<i>Setting Up Loss Measurement Analysis on page 107</i>
Peak Power Density									<i>Setting Up Peak Power Density Analysis on page 108</i>
Gain & NF									<i>Setting Up Gain and Noise Figure Analysis on page 109</i>
Pass Band Test									<i>Setting Up Pass Band Test Analysis on page 113</i>
Stop Band Test									<i>Setting Up Stop Band Test Analysis on page 119</i>
Mask Test									<i>Setting Up Mask Test Analysis on page 125</i>

To analyze a trace:

1. In the analysis mode window, touch the **Analysis Setup** tab.
2. Touch the analysis tool you want to configure and set-up the parameters as described in the appropriate analysis tool section. Tool related sections are indicated in the above table.
3. In the **<Analysis Mode>** tab, touch the  located at the left of the **Analyze** button.

The analysis menu appears.

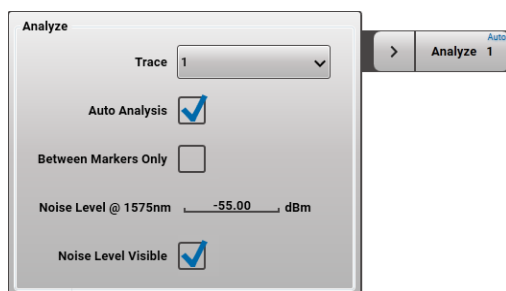

4. Define the trace you want to analyze, and set the wanted parameters according to the instructions given in the following table.

Parameter	Description
Trace	Number of the spectral trace to analyze (not available in OFA mode).
Auto Analysis	<ul style="list-style-type: none"> ▶ <input checked="" type="checkbox"/>: the analysis is automatically performed at the end of each scan and after the change of an analysis parameter (except the change of the Between Markers Only parameter). If the Between Markers Only parameter is activated and you have moved a marker, the analysis is not automatically performed: you must launch it manually by touching the Analyze button. ▶ <input type="checkbox"/>: the analysis is performed when the Analyze button is touched.
Between Markers Only	<ul style="list-style-type: none"> ▶ <input checked="" type="checkbox"/>: the analysis is only performed on the part of the trace located between markers, highlighted by two grey areas on either side of the selected area (see <i>Performing Manual Measurements With Markers</i> on page 58). ▶ <input type="checkbox"/>: the analysis is performed on the wavelength range of the trace to analyze.
Noise Level @ 1575 nm	<p>Detection threshold of the analysis tools.</p> <p>Sets the level at 1575 nm of the noise detection curve (displayed as a dotted yellow line on the graph), calculated from the noise spectrum and dependent on wavelength below which the signal is not analyzed (this avoids the detection of unwanted peaks in the noisy regions of the spectrum). To ensure good detection of peaks and troughs, it is recommended to use a value close to sensitivity (e.g. -70 dBm if sensitivity is set to -70 dBm).</p>

Parameter	Description
Noise Level Visible	▶ <input checked="" type="checkbox"/> : the defined noise level is displayed on the graph.
	▶ <input type="checkbox"/> : the defined noise level is not displayed on the graph.

To modify a numeric value, touch the wanted value to display a numeric keypad.

5. Touch the  button or anywhere on the screen outside the menu to exit.

The trace number to analyze appears on the **Analyze** button.

If you have activated the automatic analysis, the "Auto" flag appears on the top right corner of the **Analyze** button.

6. Make sure the trace to analyze is not empty. If so, perform a scan to get data on the trace.
7. If the **Auto Analysis** check box is cleared (or if the **Between Markers Only** parameter is activated and you have moved a marker), touch the **Analyze** button.

The analysis is performed according to the parameters set in the **Analysis Setup** tab and in the analysis menu. Analysis results are displayed below the graph: see *Result Area Description* on page 64.



IMPORTANT

The analysis is restricted to 1000 peaks. If more than 1000 peaks are detected, no result is displayed.

If the **Display on graph** option (available in some analysis tools) is activated, graphical display items are displayed on the graph.

Result Area Description

Depending on the selected analysis mode, analysis results are grouped by analysis tool or displayed in the form of a table of channels.

▶ **Results displayed in boxes grouped by analysis tool**

This type of display is used in the following analysis modes:

- ▶ **OSA, BBS, MML, SML and PCT** analysis modes
- ▶ **OFA** analysis mode, if the **Experimental Setup** parameter of the **Gain & NF** tool is set to **Single Source** (see *Defining Gain & NF Analysis Parameters* on page 109).

The following figure is an example window in BBS analysis mode.

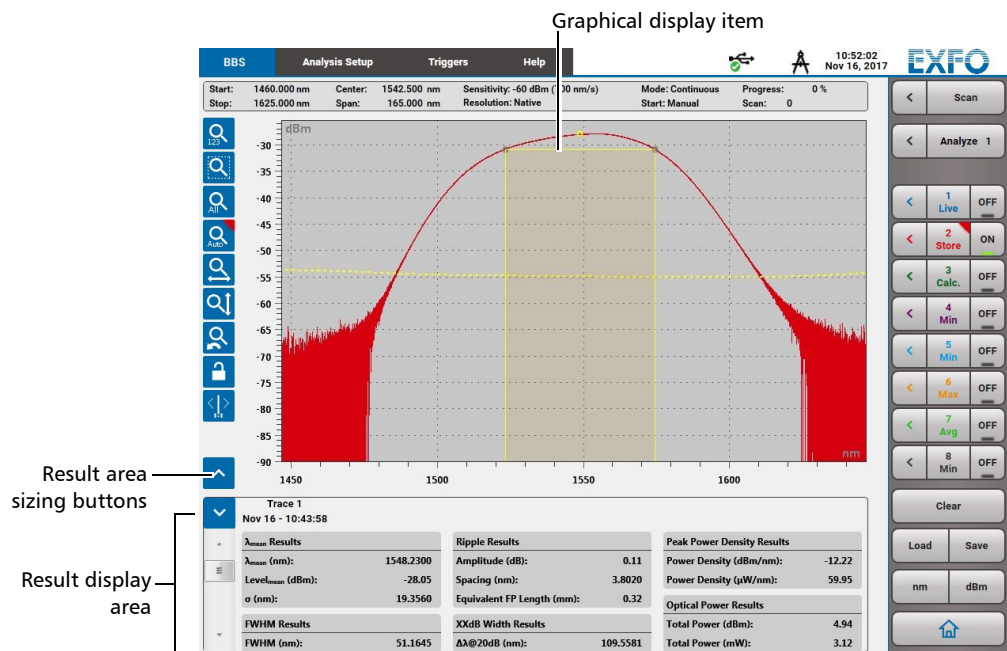

Results can be displayed in nm or THz, and in dBm or mW, depending on the measurement unit selected in the **Settings** window (see *Setting Spectral and Power Units* on page 31).

Results are grouped according to occupying the least possible space on screen. If you deactivate a tool, the results reorder.

► **Results displayed in a table of channels:**

This type of display is used in the following analysis modes:

- **WDM** and **RLT** analysis modes.
- **OFA** analysis mode, if the **Experimental Setup** parameter of the **Gain & NF** tool is set to **Multichannel** (see *Defining Gain & NF Analysis Parameters* on page 109).

Analyzing Traces

Setting Up Peaks and Troughs Search

The following figure is an example windows in WDM analysis mode.

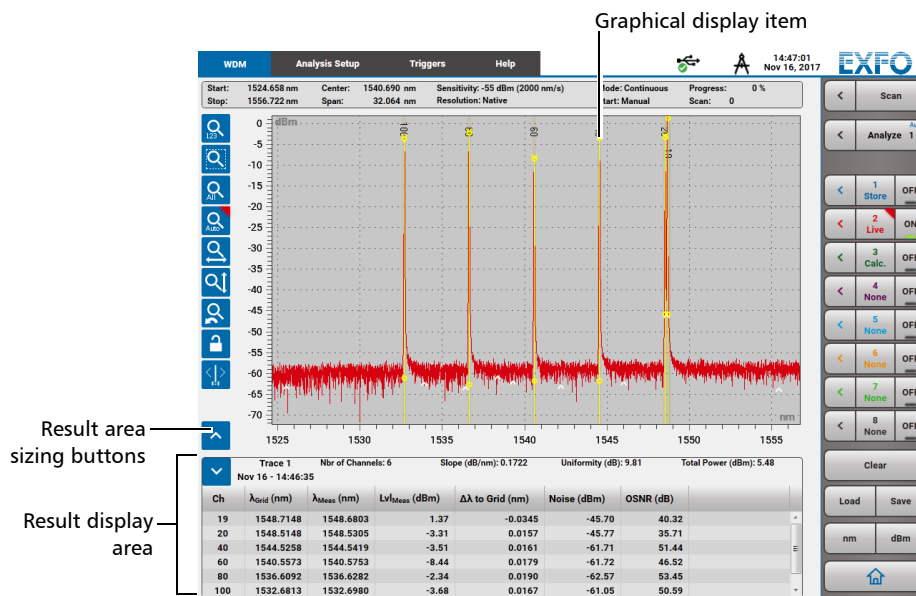

Once the scan is finished, you can touch a column title to sort it.

Setting Up Peaks and Troughs Search

The **Peak Trough Search** tool is available for configuration in the **OSA**, **WDM**, **SML**, **PCT**, **RLT** and **OFA** analysis modes. It is performed automatically in all other analysis modes (default values used for calculation are given in this section).

Defining PT Search Analysis Parameters

The **Peak Trough Search** tool allows you to identify in a spectral trace all high and low values separated from the detected local noise by a given threshold.

Peaks and troughs are only detected above the dotted yellow line of **Noise Level @ 1575 nm** defined in the Analysis menu (see **Noise Level @ 1575 nm** on page 63).

All other analysis tools are calculated from the values detected from the Peaks and Troughs Search.

To use the Peak Trough Search tool:

1. In the analysis mode window, touch the **Analysis Setup** tab.
2. Touch the **Peak Trough Search** tool and modify the parameters using the instructions given in the following section *To define the PT Search parameters:* on page 67.

The tool is automatically activated as all other tool results are calculated from the values detected with this tool

3. To make graphical display items of the analysis visible on the graph, select the **Display on Graph** check box and select the wanted display (see the following *Display on Graph* description, p. 68).

To define the PT Search parameters:**Search Settings**➤ **PT Threshold**

Threshold value for the discrimination of peaks and troughs in the spectrum.

Default values:

- OSA and PCT analysis mode: 0.5 dB
 - WDM, RLT and OFA analysis modes: 3 dB
 - SML analysis mode: 0.5 dB
 - MML and BBS analysis modes (not settable): 3 dB
- **Mode Threshold** (WDM, OFA, PCT and RLT analysis modes only)

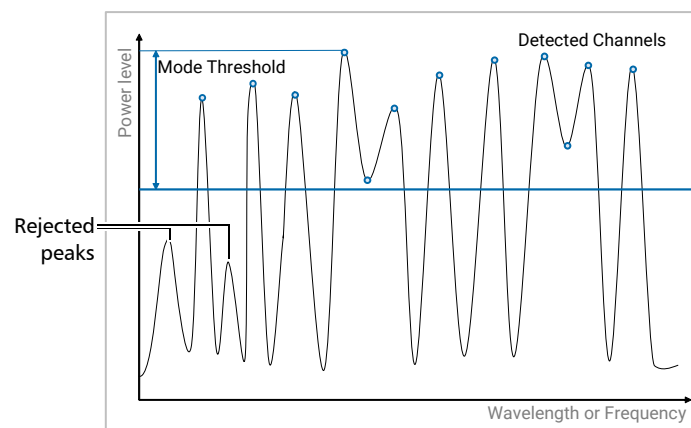

The only peaks retained are the ones with power higher than:
 $[\text{Max power}] - [\text{Mode Threshold}]$.

Default value in WDM, OFA, PCT and RLT analysis modes: 20 dB

Default value in OSA and SML analysis modes (not settable): 100 dB

➤ **Auto Noise Threshold**

- (default): the algorithm automatically detects the localized RMS noise of the measurement (over 10 points surrounding the point of interest) and deduces a value of noise threshold, below which a peak or trough cannot be effectively detected.
 This input has been introduced due to the strong dependence of spectral noise to detected power (see the following figure, in which **Noise Level @1575nm** is represented by Calculation Threshold). This noise threshold is then added to the PT threshold for the peak and trough search.
- : the algorithm does not filter the local noise.

Analyzing Traces

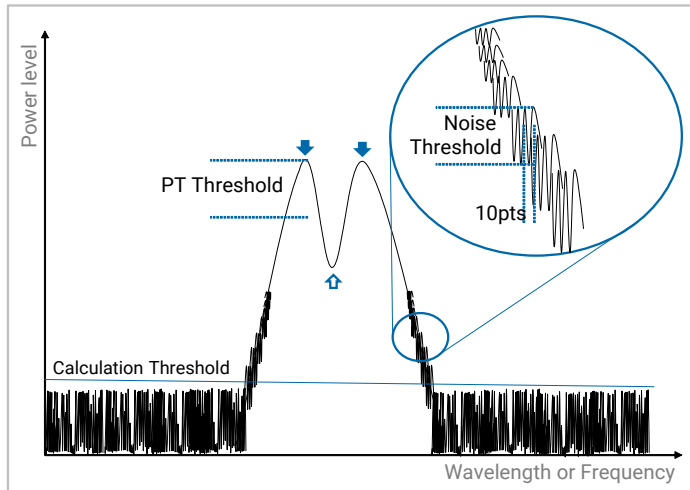

Setting Up Peaks and Troughs Search



Display on Graph

- (default for OSA, WDM, RLT and OFA analysis modes): analysis graphical items are displayed on the graph.
 - **Peaks** (default): graphical items are displayed on peaks.
 - **Troughs**: graphical items are displayed on troughs.
 - **Both**: graphical items are displayed on peaks and troughs.
- (default for BBS, MML, PCT and SML analysis modes): no graphical item is displayed on the graph.

Analyzing PT Search Results

- In the **OSA, WDM, RLT, PCT** and **OFA** analysis modes, the results of Peaks and Troughs Search tool are visible on the graph, if you have selected the **Display on Graph** option:
 -  : graphical display item displayed on peaks.
 -  : graphical display item displayed on troughs.
- In **OFA** mode, PT search runs only on Trace OUT. Results for Trace IN (OSNR IN) are calculated using the list of peaks obtained on Trace OUT.
- In the **WDM, RLT, PCT** and **OFA** analysis modes: result values are displayed for each detected peak, in accordance with the value set for the **Mode Threshold** parameter.
- In all other analysis modes, no result is displayed on graph.

Selecting the Component Under Test (PCT Mode)











The **Component Selector** tool is only available in **PCT** analysis mode.

It enables you to select the component to test and automatically adapts the list of available analysis tools.

To select the component under test:

1. In the **PCT** analysis mode window, touch the **Analysis Setup** tab.
2. Touch the **Component Selector** tool and select the type of component under test.

The tool makes available the analysis tools adapted to the selected component.

Component Type Analysis Tool	Pass Band Filter	Stop Band Filter	Isolator	Fiber	Related Section
Spectral Width 1 Spectral Width 2 Spectral Width 3					<i>Setting Up Spectral Width Analysis on page 76</i>
Notch Width 1 Notch Width 2 Notch Width 3					<i>Setting Up Notch Width Analysis on page 89</i>
Pass Band Test					<i>Setting Up Pass Band Test Analysis on page 113</i>
Stop Band Test					<i>Setting Up Stop Band Test Analysis on page 119</i>
Loss Measurement					<i>Setting Up Loss Measurement Analysis on page 107</i>
Mask Test					<i>Setting Up Mask Test Analysis on page 125</i>

Setting Up Channel Detection

The **Channel Detection** tool is available in the **WDM**, **RLT** and **OFA** analysis modes.

In OFA mode, the channel detection is only used if the **Experimental Setup** parameter of the **Gain & NF** tool is set to **Multichannel** (see *Defining Gain & NF Analysis Parameters* on page 109).

Defining Channel Detection Analysis Parameters

The **Channel Detection** tool allows you to identify in a spectral trace the number, wavelength and power of WDM channels.

To use the Channel Detection tool:

1. In the analysis mode window, touch the **Analysis Setup** tab.
2. Touch the **Channel Detection** tool and modify the parameters using the instructions given in the following *To define the Channel Detection parameters:* on page 70.

This analysis tool is always activated as results from the other tools are calculated from the values detected with this tool

3. To make graphical display items of the analysis on the graph visible, select the **Display on Graph** check box.

To define the Channel Detection parameters:

Channel Detection Settings

The **Peaks Trough Search** tool (see *Setting Up Peaks and Troughs Search* on page 66) allows the identification of all candidate channels.

WDM Display Mode

Method used to calculate the results of the WDM channels detection algorithm.

► **Grid** (default)

The grid channel array is first calculated based on the **Start Wavelength**, the **Stop Wavelength** and the **Grid Spacing**.

The reference frequency can be set to any frequency with the **Reference Frequency** parameter (see below, p. 71). All other channels are then calculated from that reference channel labeled "Channel 0".

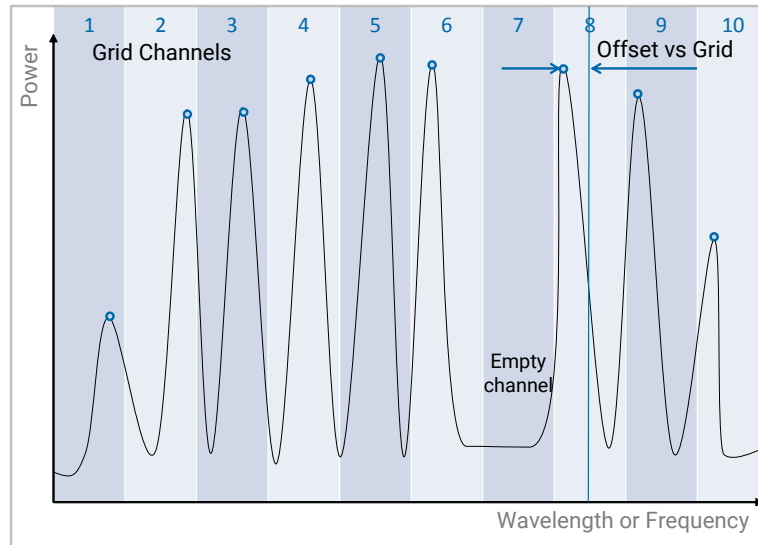

In this process, some of the detected peaks are rejected, either because they are not within the range of the grid, or they are duplicate peaks within a single grid channel. In the latter case, the peak with the highest power is set as the mode.

➤ **Bandwidth Threshold**

Threshold used in the calculation of the central wavelength/frequency of the signal, that defines two wavelengths λ^- and λ^+ with Power $P = P_{\text{peak}} - \text{Bandwidth Threshold}$.

For correct identification of channels, it is recommended that this threshold be less than **PT Threshold** (see p. 67).

$$\text{Central wavelength/frequency} = (\lambda^+ + \lambda^-)/2$$

Default value: 3 dB

➤ **Grid Spacing**

Spacing value for the grid.

Default value: 12.5 GHz

➤ **Reference Frequency**

Center frequency value of the channel number 0. The center frequency of channel N is calculated from the Reference Frequency f, and the Grid Spacing. All other channels are calculated from this frequency as:

$$f(\text{channelnumber}N) = f(\text{reference}) + N * \text{GridSpacing}$$

Default value: 193.1 THz (ITU standard)

➤ **Start Wavelength/Frequency**

Center wavelength or frequency value (depending on the selected measurement unit, see *Setting Spectral and Power Units* on page 31) of the first channel on the grid.

Default value: 1520 nm / 197.232 THz

► Stop Wavelength/Frequency

Center wavelength or frequency value (depending on the selected measurement unit, see *Setting Spectral and Power Units* on page 31) of the last channel on the grid.

Default value: 1620 nm / 185.057 THz

► Empty Channels:

To avoid slowing the acquisition, empty channels are not displayed on graph.

► Show: all available channels are displayed in the table of results.



IMPORTANT

Depending on the number of empty channels, selecting this option can slow acquisition and column sorting.

► Hide (default): empty channels (i.e. with no detected power) are not displayed in the table of results.

► Per Channel

Only the detected channels are labeled and displayed. Channel 1 being the channel with the smallest wavelength or frequency depending on unit used.

The following figure illustrates the Per Channel display mode: **Offset** method on the left, **Spacing** method on the right.

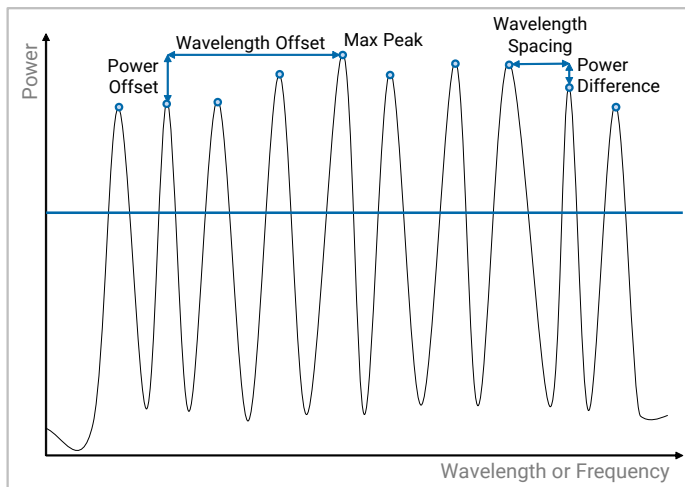

► Bandwidth Threshold

Threshold used in the calculation of the central wavelength/frequency of the signal, that defines two wavelengths λ^- and λ^+ with Power $P = P_{\text{peak}} - \text{Bandwidth Threshold}$.

For correct identification of channels, it is recommended that this threshold be less than **PT Threshold** (see p. 67).

$$\text{Central wavelength/frequency} = (\lambda^+ + \lambda^-)/2$$

Default value: 3 dB

- **Channel Display Mode** (WDM and RLT analysis modes only)
Type of display of channels.
- **Offset** (default): the wavelength offset and power offset is calculated between the corresponding channel and the **Reference Channel**.
- **Spacing**: the wavelength spacing and power difference is calculated between each channel N and its corresponding neighbor $N-1$.
- **Reference Channel** (only in WDM and RLT analysis modes, if **Channel Display Mode** is set to **Offset**): reference channel for all calculation.
Maximum (default): the peak with maximum power detected is the reference channel for calculation.
Channel Number: the **Channel Number** entered is the reference channel for calculation.
If the channel number does not exist (i.e. Channel Number > Number of channel), the calculation is made on the detected peak with maximum power.
- **Channel Number** (WDM and RLT analysis modes only, if **Reference Channel** is set to **Channel Number**): channel to use as reference channel.
Default value: 1
- **CWDM**
Generates a CWDM grid: 20 nm spacing and center wavelength of 1270 nm to 1610 nm or 1271 nm to 1611 nm
- **Bandwidth Threshold**
Threshold used in the calculation of the central wavelength/frequency of the signal, that defines two wavelengths λ^- and λ^+ with Power $P = P_{\text{peak}} - \text{Bandwidth Threshold}$.
For correct identification of channels, it is recommended that this threshold be less than **PT Threshold** (see p. 67).
Central wavelength/frequency = $(\lambda^+ + \lambda^-)/2$
Default value: 3 dB
- **First Channel** (WDM, RLT and OFA analysis modes only)
Wavelength of the first channel of the CWDM grid:
1270 nm: the first CWDM channel is centered on 1270 nm.
1271 nm (default): the first CWDM channel is centered on 1271 nm.

Analyzing WDM Channel Detection Results

Analysis results are displayed below the graph (see *Result Area Description* on page 64).



IMPORTANT

The analysis is restricted to 1000 peaks. If more than 1000 peaks are detected, no result is displayed.

To analyze results displayed on graph:

If you have selected the Display on Graph check box, the following graphical items are displayed on graph:

- Areas alternately pink and grey identify the channels.
- Channel numbers are displayed at the top of the graph.

To analyze results displayed in the Result area:

- **List** (WDM analysis mode only)

If no peaks are detected at the end of the scan, no value is displayed.

- **Nbr of channels:** number of detected channels.
- **Slope:** linear fit slope of all detected peak power in dB/nm or dB/THz, depending on the selected measurement unit (see *Setting Spectral and Power Units* on page 31). It does not take the integrated power in channel, it only takes the peak power.
- **Uniformity:** difference between maximum and minimum detected peak power. It does not take the integrated power in channel, it only takes the peak power.
- **Total Power:** WDM and RLT modes only.
Power measured within the scan range in dBm. If no power (or negative power) is detected, the result displays -100 dBm.

- **Table**

Column name	Meaning
Grid and CWDM Display Mode	
Ch	Channel number, following the grid channel numbering (even if Empty Channels is set to Hide).
$\lambda_{\text{Grid}}/v_{\text{Grid}}$	WDM and RLT modes only. Wavelength/Frequency of channel of the grid starting from the Start Wavelength/Frequency value and stopping at Stop Wavelength/Frequency value.
$\lambda_{\text{Meas}}/v_{\text{Meas}}$	Measured channel peak wavelength/frequency and its associated power.
Lvl_{Meas}	WDM and RLT modes only. Measured channel peak power.

Column name	Meaning
$\Delta\lambda$ to Grid/ $\Delta\nu$ to Grid	WDM and RLT modes only. Wavelength/Frequency offset of the channel compared to the nearest grid channel.
Per Channel Display Mode	
Ch	Channel number, starting at channel no 1, and incremented every peak.
$\lambda_{\text{Ctr}}/\nu_{\text{Ctr}}$	Measured channel peak wavelength/frequency.
Lvl_{Ctr}	WDM and RLT modes only. Measured channel peak power.
λ Offset/ ν Offset Lvl Offset	WDM and RLT modes only. Only if the Offset display mode is selected. Offset in wavelength/frequency and power of the channel compared to the reference channel. The reference channel displays an offset of 0 and a power offset of 0
$\Delta\lambda/\Delta\nu$	WDM and RLT modes only. Only if the Spacing display mode is selected. Spacing in wavelength/frequency of the channel N compared to its neighboring channel ($N-1$).
$\Delta\lambda\text{Lvl}$	WDM and RLT modes only. Only if the Spacing display mode is selected. Power difference of the channel N compared to its neighboring channel ($N-1$).

Setting Up Spectral Width Analysis

The **Spectral Width** analysis tool is available in the **OSA**, **MML** and **SML** analysis modes.

The **Spectral Width 1**, **Spectral Width 2** and **Spectral Width 3** analysis tools are available in the **PCT** analysis mode.

Defining Spectral Width Analysis Parameters

The **Spectral Width** tool allows you to identify in a spectral trace the width of the main peak at a given threshold below the peak power, the central wavelength and the number of modes detected.

This tool applies only on peaks. For trough width measurement, see *Setting Up Notch Width Analysis* on page 89.

To use the Spectral Width analysis tool:

1. In the analysis mode window, touch the **Analysis Setup** tab.
2. In **PCT** mode, touch the **Component Selector** tool and set the **Type** parameter to **Pass Band Filter**,

The **Spectral Width 1**, **Spectral Width 2** and **Spectral Width 3** analysis tools are automatically active.
3. Touch the **Spectral Width** tool and modify the parameters using the instructions given in the following *To define the Spectral Width Parameters:* on page 76.
4. In **OSA**, **MML** and **SML** modes, activate the analysis calculation for the next analysis run by selecting the **Activate** check box.
5. To make graphical display items of the analysis visible on the graph, select the **Display on Graph** check box.

To define the Spectral Width Parameters:

Spectral Width Detection Settings

- **Algorithm:** method used for the calculation of the width.
 - **Threshold** (default)

The Threshold algorithm detects the wavelengths λ^- and λ^+ at which the power falls below [Peak Power]-[Width Threshold]. To account for the multimodal nature of some sources, several options are available for this algorithm (see *Fitting Options* below), illustrated in the following figure.

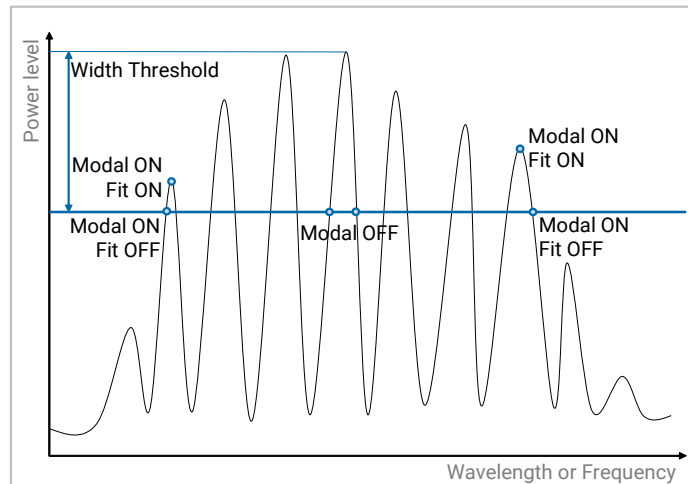

► **Envelope**

The Envelope algorithm defines an envelope from the peaks of the spectrum above **Mode Threshold** (linear fit between each peak on log scale) and deduces the width based on that envelope, as shown in the following figure.

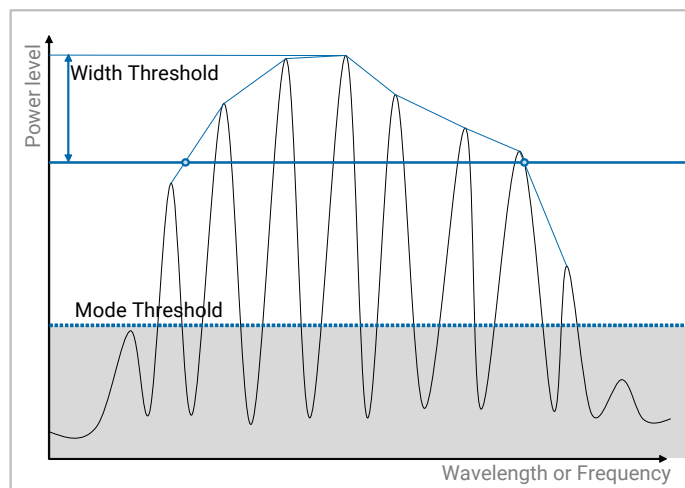

► **RMS/RMS Peak**

The RMS and RMS Peak algorithms calculate the root mean square value σ of the power data above a given **Width Threshold**, taking the full power data (RMS) or simply the Power at Peak (RMS Peak) for the calculation.

Analyzing Traces

Setting Up Spectral Width Analysis

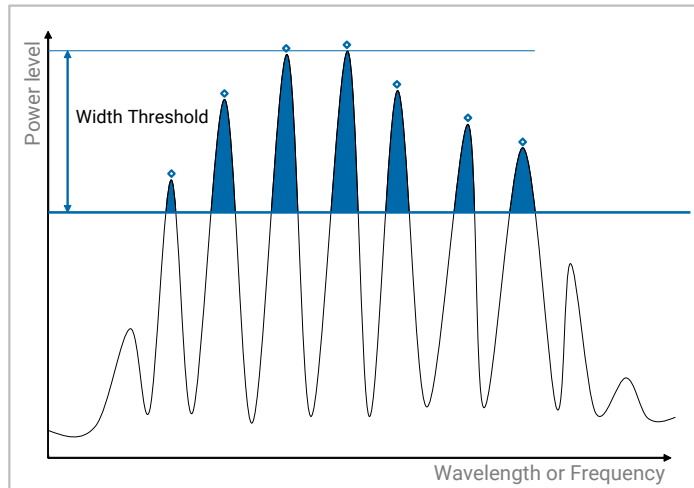

► Gaussian Fit/Lorentzian Fit

The Gaussian Fit and Lorentzian Fit algorithms fit a curve to the data and calculate the spectral parameters using **Width Threshold** from this fit.

If **Modal Analysis** is set to OFF (see *Fitting Options* below), the curve fits a Gaussian or Lorentzian to the main peak.

If **Modal Analysis** is set to ON, the curve fits a Gaussian or Lorentzian to all peaks above **Mode Threshold**.

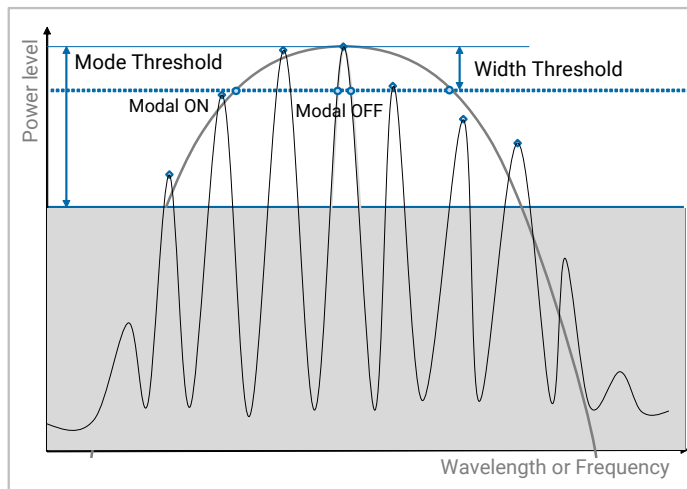

► Multiplier

Factor to scale the measured width.

Default value: 1

► Width Threshold

Threshold level used in the calculation of the width. It defines two wavelengths λ^- and λ^+ with Power $P = P_{\text{peak}} - \text{Width Threshold}$.

- Default value (OSA and SML analysis modes): 3 dB
Default value (MML analysis mode): 40 dB
- **Mode Threshold** (only for **Envelope**, **Gaussian Fit** and **Lorentzian Fit** algorithms).
Retains peaks with power $P > P_{\text{peak}} - \text{Mode Threshold}$.
Default value: 50 dB

Fitting Options

- **Modal Analysis** (only for **Threshold**, **Gaussian Fit** and **Lorentzian Fit** algorithms).
 - : the measurement includes all detected peaks above **Width Threshold** (Threshold algorithm) or **Mode Threshold** (Gaussian Fit/Lorentzian Fit algorithms).
 - : the measurement includes a single peak (the main peak).

Default value (OSA, and MML analysis modes):



Default value (SML analysis mode):
- **Fit to Mode** (only for **Threshold** algorithm, if **Modal Analysis** check-box is selected).
 - : the calculation of width is fitted to the nearest detected peaks.
 - (default): the calculation of width is fitted to the curve-threshold crossing.

Analyzing Spectral Width Results

Analysis results are displayed below the graph (see *Result Area Description* on page 64).

Results Displayed on Graph

If you have selected the **Display on Graph** check box, the following graphical items are displayed on graph:

-  is displayed on the mean wavelength/frequency
-  is displayed on λ^+ and λ^- .
-  is displayed between λ^- and λ^+ .

Result Area

Column name	Meaning
$\lambda_{\text{mean}}/V_{\text{mean}}$	Calculated central wavelength/frequency and its associated power.
Level _{mean}	For RMS , RMS Peak and Gaussian algorithms, the central wavelength is the mean wavelength.
$\lambda_{\text{center}}/V_{\text{center}}$	(MML analysis mode only)
Level _{center}	Calculated central wavelength and its associated power. For RMS , RMS Peak and Gaussian algorithms, the central wavelength is the mean wavelength.
$\lambda_{\text{peak}}/V_{\text{peak}}$	Spectral Width 1/2/3 tool only.
Level _{peak}	Calculated peak wavelength/frequency and its associated power.
$\Delta\lambda@xx\text{dB}/$ $\Delta\nu@xx\text{dB}$	Width at Width Threshold using the selected algorithm method. For RMS and RMS Peak algorithms, the width is the standard deviation (σ).
Number of Modes	(OSA and MML modes only) Number of detected peaks within the width. For RMS and RMS Peak algorithms, the number of modes is the number of peaks detected above threshold.
Mode Spacing	(OSA and MML modes only) Calculated mode spacing value. For RMS and RMS Peak algorithms, the spacing is calculated using the peaks above threshold.
σ	Only for RMS and RMS Peak algorithms. Standard deviation value of the measured peak.

Setting Up XXdB Width Analysis

The **XXdB Width** analysis tool is available in **BBS** analysis mode.

Defining XXdB Width Analysis Parameters

The **XXdB Width** tool allows you to identify the spectral width at a given threshold value.

To use the XXdB Width analysis tool:

1. In the BBS analysis mode window, touch the **Analysis Setup** tab.
2. Touch the **XXdB Width** tool and modify the parameters using the instructions given in the following *To define the xxdB Width Parameters:* on page 81.
3. Activate the analysis calculation for the next analysis run by selecting the **Activate** check box.
4. To make graphical display items of the analysis visible on the graph, select the **Display on Graph** check box.

To define the xxdB Width Parameters:

Width Measurement Settings

- **Algorithm:** method used for the calculation of the width.
 - **Threshold (default)**

The Threshold algorithm detects the wavelengths λ^- and λ^+ at which the power falls below [Peak Power]-[Width Threshold].

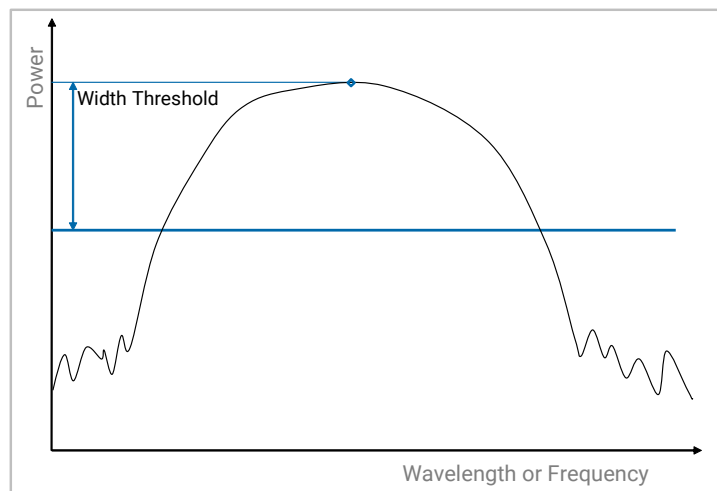

- **RMS**

The RMS algorithm calculates the root mean square value σ of the power data above a given **Width Threshold**, taking the full power data for the calculation.

Analyzing Traces

Setting Up XXdB Width Analysis

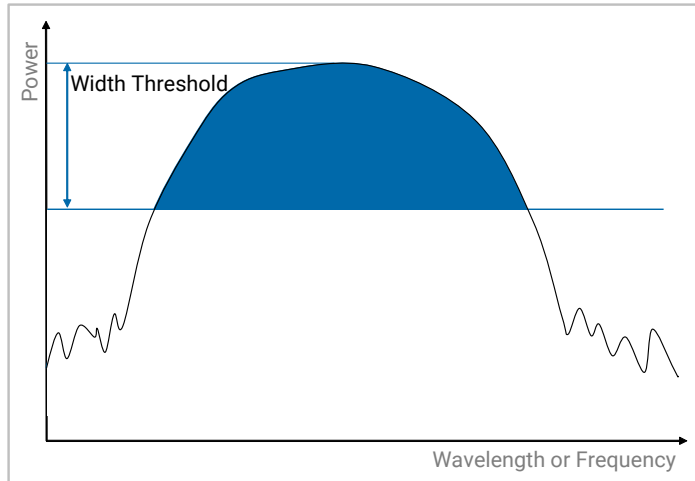

► Gaussian Fit/Lorentzian Fit

The Gaussian Fit and Lorentzian Fit algorithms fit a curve to the data and calculate the spectral parameters using **Width Threshold** from this fit.

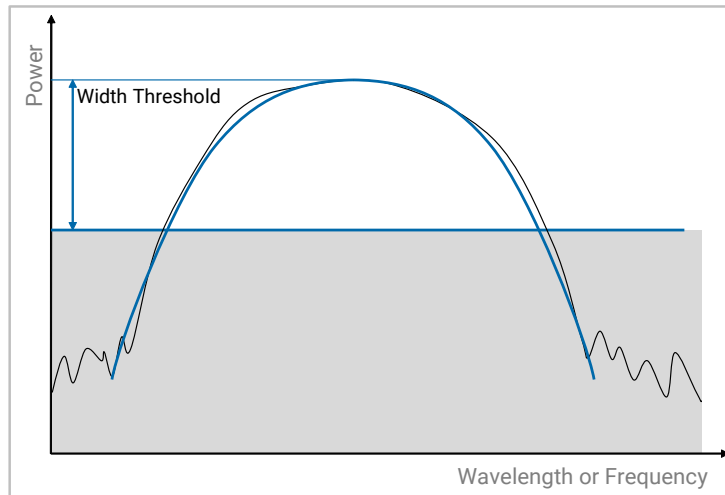

► Multiplier

Factor to scale the measured width.

Default value: 1

► Width Threshold

Threshold level used in the calculation of the width. It defines two wavelengths λ^- and λ^+ with Power $P = P_{\text{peak}} - \text{Width Threshold}$.

Default value: 20 dB

► Mode Threshold (only for Envelope, Gaussian Fit and Lorentzian Fit algorithms).

Retains peaks with power $P > P_{\text{peak}} - \text{Mode Threshold}$.



Default value: 20 dB

Analyzing XXdB Width Results

Analysis results are displayed below the graph (see *Result Area Description* on page 64).

Results Displayed on Graph

If you have selected the Display on Graph check box, the following graphical items are displayed on graph:

-  is displayed on the mean wavelength/frequency.
-  is displayed on λ^+ and λ^- .
-  is displayed between λ^- and λ^+ .

Result Area

Result	Meaning
$\Delta\lambda@xxdB/$ $\Delta\nu@xxdB$	Width at Width Threshold using the selected algorithm method. For RMS and RMS Peak algorithms, the width is the standard deviation (σ).

Setting Up Mean Wavelength/Frequency Analysis

The λ_{mean} analysis tool is available in the **BBS** and **MML** analysis mode. It can only be modified in the **BBS** analysis mode.

Defining Mean Wavelength/Frequency Analysis Parameters

The λ_{mean} tool allows you to identify the mean wavelength of the main peak at a given threshold value.

To use the Mean Wavelength/Frequency analysis tool:

1. In the **BBS** analysis mode window, touch the **Analysis Setup** tab.
2. Touch the λ_{mean} tool and modify the parameters using the instructions given in the following section *To define the Mean Wavelength/Frequency Parameters:* on page 84.
3. Activate the analysis calculation for the next analysis run by selecting the **Activate** check box.
4. To make graphical display items of the analysis visible on the graph, select the **Display on Graph** check box.

To define the Mean Wavelength/Frequency Parameters:

Mean Wavelength/Frequency Measurement Settings

In the **BBS** analysis mode, the RMS algorithm is used for the calculation of the mean wavelength (for more details, see **RMS** on page 81).

➤ **Width Threshold**

Threshold level used in the calculation of the width. It defines two wavelengths λ^- and λ^+ with Power $P = P_{\text{peak}} - \text{Width Threshold}$.

Default value: 20 dB

In the **MML** analysis mode, the RMS Peak algorithm is used for the calculation of the mean wavelength with the following default parameters (for more details, see **RMS** on page 81):



- **Width Threshold:** 20 dB
- **Mode Threshold:** 40 dB
- **Multiplier:** 1
- **Fit to Mode:** No
- **Modal analysis:** Yes

Analyzing Mean Wavelength/Frequency Results

Analysis results are displayed below the graph (see *Result Area Description* on page 64).

Results Displayed on Graph

If you have selected the Display on Graph check box, the following graphical items are displayed on graph:

-  is displayed on the mean wavelength/frequency.
-  is displayed on λ^+ and λ^- .
-  is displayed between λ^- and λ^+ .

Result Area

Result	Meaning
$\lambda_{\text{mean}}/V_{\text{mean}}$	Calculated mean wavelength/frequency.
Level _{mean}	Power level at mean wavelength/frequency.
σ	Standard deviation value of the measured peak.

Analyzing Peak Wavelength/Frequency Results

The peak wavelength is available for the MML analysis mode. The analysis settings cannot be modified.



Peak Wavelength/Frequency Measurement Settings

For more details on measurement settings, see *Defining Mean Wavelength/Frequency Analysis Parameters* on page 84.

- **Algorithm:** Threshold
- **Width Threshold:** 3
- **Mode Threshold:** 50
- **Multiplier:** 1
- **Fit to Mode:** No
- **Modal Analysis:** No

Results Displayed on Graph

The following graphical display items are displayed on graph:

-  is displayed on the peak wavelength.
-  is displayed on λ^+ and λ^- .
-  is displayed between λ^- and λ^+ .

Result Area

Result	Meaning
$\lambda_{\text{peak}}/V_{\text{peak}}$	Wavelength/frequency of the main mode.
Level _{peak}	Power of the main mode.

The central wavelength and sigma value is available in the **SML** analysis mode. The analysis settings cannot be modified.



Central Wavelength and Sigma Measurement Settings

For more details on measurement settings, see *Defining Spectral Width Analysis Parameters* on page 76.

- **Algorithm:** RMS
- **Width Threshold:** 3
- **Mode Threshold:** 50
- **Multiplier:** 1
- **Fit to Mode:** No
- **Modal Analysis:** No

Results Displayed on Graph

The following graphical display items are displayed on graph:

-  is displayed on the center wavelength.
-  is displayed on λ^+ and λ^- .
-  is displayed between λ^- and λ^+ .

Result Area

Result	Meaning
$\lambda_{\text{center}}/v_{\text{center}}$	Central wavelength/frequency.
σ	Standard deviation of the measured peak.

Analyzing FWHM Results

The full width at half maximum result is available for the **BBS** and **MML** analysis modes. The analysis settings cannot be modified.

FWHM Measurement Settings

For more details on measurement settings, see *Defining Spectral Width Analysis Parameters* on page 76.

BBS Analysis Mode

- **Algorithm:** Threshold
- **Width Threshold:** 3
- **Mode Threshold:** 12
- **Multiplier:** 1
- **Fit to Mode:** No
- **Modal Analysis:** No

MML Analysis Mode

- **Algorithm:** Gaussian Fit
- **Width Threshold:** 3
- **Mode Threshold:** 20
- **Multiplier:** 1
- **Fit to Mode:** No
- **Modal Analysis:** Yes

Result Description

Result	Meaning
FWHM	Full width at half maximum value.

Analyzing Side Modes Spacing Results

The Side Modes Spacing analysis result is available in the **SML** analysis mode. The analysis settings cannot be modified.

Side Modes Spacing Measurement Settings

For more details on measurement settings, see *Defining Spectral Width Analysis Parameters* on page 76.

- **Algorithm:** Threshold
- **Multiplier:** 1
- **Width Threshold:** 50
- **Modal Analysis:** Yes
- **Fit to Mode:** No

Result Description

Analysis results are displayed below the graph (see *Result Area Description* on page 64).

Result	Meaning
Side Modes Spacing	Calculated spacing of the residual side mode detected (when possible) outside of the main peak feature.

Setting Up Notch Width Analysis

The **Notch Width** analysis tool is available in the **OSA** analysis mode.

The **Notch Width 1**, **Notch Width 2** and **Notch Width 3** analysis tools are available in the **PCT** analysis mode.

Defining Notch Width Analysis Parameters

The **Notch Width** tool allows you to identify in a spectral trace the width of a trough at a given threshold above the trough power (see "Bottom" in **Notch Selection Options** on page 90) or below the surrounding peaks (see "Top" in **Notch Selection Options** on page 90).

To use the Notch Width analysis tool:

1. In the analysis mode window, touch the **Analysis Setup** tab.
2. In **PCT** mode, touch the **Component Selector** tool and set the **Type** parameter to **Stop Band Filter** or **Isolator**.
3. The **Notch Width 1**, **Notch Width 2** and **Notch Width 3** analysis tools are automatically active.
4. Touch the **Notch Width** tool and modify the parameters using the instructions given in the following *To define the Notch Width parameters:* on page 89.
5. In **OSA** mode, activate the analysis calculation for the next analysis run by selecting the **Activate** check box.
6. To make graphical display items of the analysis visible on the graph, select the **Display on Graph** check box.

To define the Notch Width parameters:

Notch Width Detection Settings

- **Algorithm:** fit to apply for the determination of the width.
The fitting is mono-modal (the **Modal Analysis** option is not available).
 - **Threshold** (default): no fit is applied.
 - **Gaussian/Lorentzian Fit:** the Gaussian Fit and Lorentzian Fit algorithms fit a curve to the data and calculate the spectral parameters using **Width Threshold** from this fit. The curve is fitted to the main trough.
- **Multiplier**
Factor to scale the measured width.
Default value: 1
- **Width Threshold**
Threshold level used in the calculation of the width. It defines two wavelengths λ^- and λ^+ with Power $P = P_{\text{peak}} - \text{Width Threshold}$.
Default value: 3 dB

Analyzing Traces

Setting Up Notch Width Analysis

Notch Selection Options

- **Notch Selection:** method used for the selection of the trough to analyze.
 - **Deepest Notch:** selection of the feature with biggest difference between trough and adjacent peaks.
 - **Minimum Trough (default):** selection of the lowest level trough.

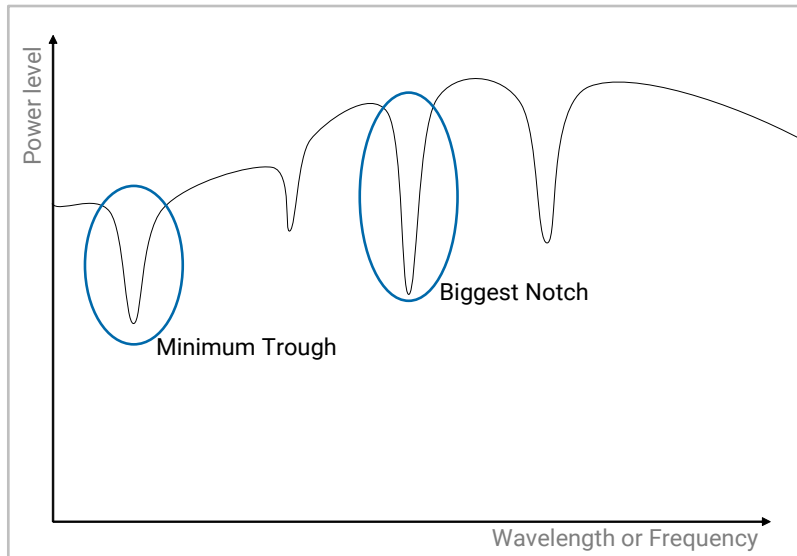

- **Width Reference:** method used for the measurement of the width.
 - **Bottom (default):** the width is calculated from the trough.
 - **Top:** the width is calculated from the two surrounding peaks on either side of the notch to be analyzed.

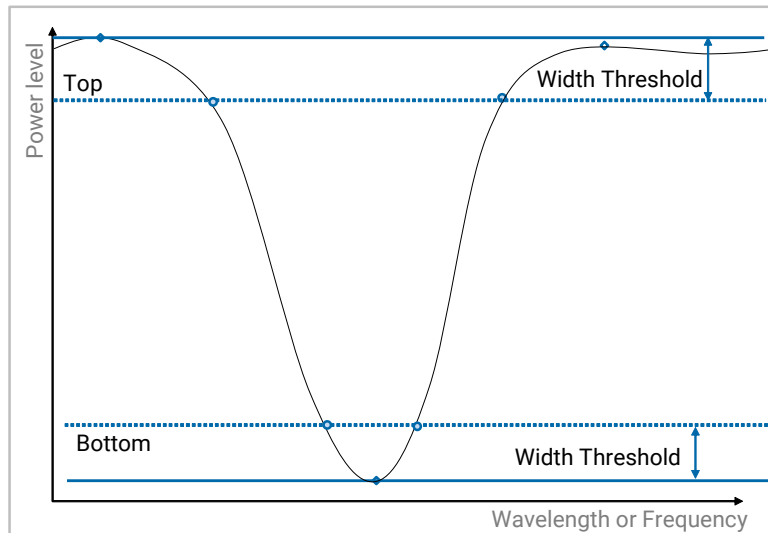



Analyzing Notch Width Results

Analysis results are displayed below the graph (see *Result Area Description* on page 64).

If no peaks are detected at the end of the scan, no value is displayed.

Results Displayed on Graph

If you have selected the Display on Graph check box, the following graphical items are displayed on graph:

-  displayed on the notch wavelength.
-  is displayed on λ^+ and λ^- .

Result Area

To be detected correctly, the trough must not be below the **Noise Level @1575 nm** value (see **Noise Level @ 1575 nm** on page 63).

Result	Meaning
$\lambda_{\text{notch}}/V_{\text{mean}}$	Calculated central wavelength/frequency and its associated power.
Level _{notch}	
$\lambda_{\text{trough}}/V_{\text{trough}}$	Notch Width 1/2/3 tool only.
Level _{trough}	Calculated trough wavelength/frequency and its associated power.
$\Delta\lambda_{\text{notch}}/\Delta V_{\text{notch}}$	Spectral notch width at Width Threshold using the selected algorithm method.

Setting Up Level Check Analysis

The Level Check analysis tool is available in the **OSA** analysis mode.

Defining Level Check Analysis Parameters

The **Level Check** tool allows you to measure, on the analyzed trace, the optical power level at several wavelengths, and to calculate the level difference between those wavelengths.

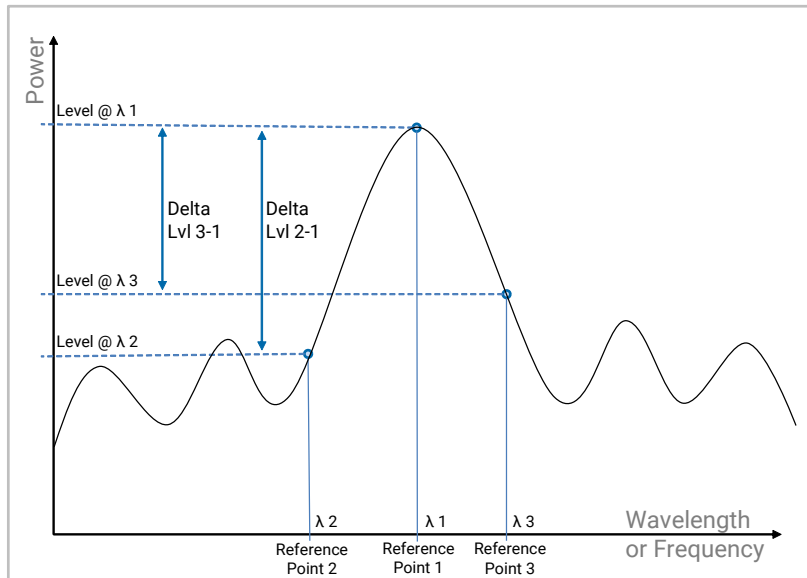

To use the Level Check analysis tool:

1. In the **OSA** analysis mode window, touch the **Analysis Setup** tab.
2. Touch the **Level Check** tool and modify the parameters using the instructions given in the following *To define the Level Check Parameters:* on page 92.
3. Activate the analysis calculation for the next analysis run by selecting the **Activate** check box.
4. To make graphical display items of the analysis visible on the graph, select the **Display on Graph** check box.

To define the Level Check Parameters:

Level Check Settings

➤ **Reference Point 1/2/3**

Wavelength/frequency of the point for which the power level is measured.

Default values:

- Reference Point 1: 1520 nm or 197.232 THz
- Reference Point 2: 1550 nm or 193.414 THz
- Reference Point 3: 1570 nm or 190.950 THz

Analyzing Level Check Results

Analysis results are displayed below the graph (see *Result Area Description* on page 64).

Results Displayed on Graph

If you have selected the Display on Graph check box, the following graphical items are displayed on graph:

-  indicates the position of the wavelength reference points and their corresponding power level.

Result Area

Result	Meaning
Level@λ1/2/3 Level@ν1/2/3	Optical power measured at reference point 1/2/3.
ΔLv12-1	Difference in dB between the power level measured at Reference Point 2 and the power level measured at Reference Point 1 .
ΔLv13-1	Difference in dB between the power level measured at Reference Point 3 and the power level measured at Reference Point 1 .

Setting Up SMSR Analysis

The SMSR analysis tool is available in **OSA** and **SML** analysis modes.

Defining SMSR Analysis Parameters

The **SMSR** tool allows you to get results linked to the Side Mode Suppression Ratio of modes outside a masked area (in nm).

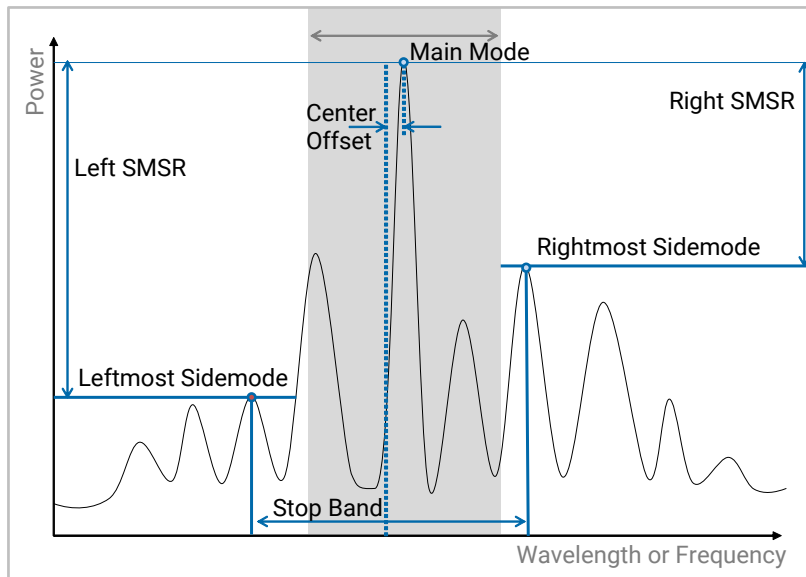

To use the SMSR analysis tool:

1. In the **OSA** analysis mode window, touch the **Analysis Setup** tab.
2. Touch the **SMSR** tool and modify the parameters using the instructions given in the following *To define the SMSR Parameters:* on page 94.
3. Activate the analysis calculation for the next analysis run by selecting the **Activate** check box.
4. To make graphical display items of the analysis visible on the graph, select the **Display on Graph** check box.

To define the SMSR Parameters:

Side Mode Detection Settings

➤ Algorithm

- **LR** (default): displays the side modes to the left and the right of the main peak.
- **Next**: displays only the largest side mode between the identified left and right side modes outside of the **Mask** exclusion area.

➤ **Side Mode Calculation**

- **Highest** (default): returns the side modes with highest detected power (as required in IEC 61280-1-3).
- **Nearest**: returns the side modes that are closest to the peak, outside the mask area.

➤ **Mask**

Width of the mask area, centered on the main peak. All modes within this area are excluded from the calculation.



Default value: 0 nm/THz

Analyzing SMSR Results

Analysis results are displayed below the graph (see *Result Area Description* on page 64).

Results Displayed on Graph

If you have selected the Display on Graph check box, the following graphical items are displayed on graph:

-  is displayed on the mean wavelength/frequency and on side mode 1 and side mode 2.
-  is displayed between side mode 1 and side mode 2.

Result Area

Result	Meaning
Main Mode Results	
$\lambda_{\text{peak}}/v_{\text{peak}}$	Wavelength/Frequency and power of the main mode.
$\text{Level}_{\text{peak}}$	
SideBand Results (only if Algorithm is set to Next)	
$\lambda_{\text{SideMode}}$	Only if Algorithm is set to Next .
v_{SideMode}	Wavelength and power of the side mode with the highest power.
$\text{Level}_{\text{SideMode}}$	The side mode is nearest to the peak, or the highest on that side of the peak.
$\Delta\lambda_{\text{SMSR}}/\Delta v_{\text{SMSR}}$	Only if Algorithm is set to Next . Difference between the wavelength/frequency of the main mode and the wavelength/frequency of the side mode.
SMSR	Only if Algorithm is set to Next . Difference between the power of the main mode and the power of the side mode.
SideBand 1/SideBand 2 Results (only if Algorithm is set to LR)	

Analyzing Traces

Setting Up SMSR Analysis

Result	Meaning
$\lambda_{\text{SideMode 1}}$ $V_{\text{SideMode 1}}$ $\text{Level}_{\text{SideMode 1}}$ $\lambda_{\text{SideMode 2}}$ $V_{\text{SideMode 2}}$ $\text{Level}_{\text{SideMode 2}}$	Only if Algorithm is set to LR . Wavelength and power of the side mode on the left/right of the main mode.
$\Delta\lambda_{\text{SMSR 1}}$ $\Delta V_{\text{SMSR 1}}$ $\Delta\lambda_{\text{SMSR 2}}$ $\Delta V_{\text{SMSR 2}}$	Only if Algorithm is set to LR . Difference between the wavelength/frequency of the main mode and the wavelength/frequency of the side mode on the left/right of the main mode.
SMSR 1 SMSR 2	Only if Algorithm is set to LR . Difference between the power of the main mode and the power of the side mode on the left/right of the main mode.
Stop Band	Only if Algorithm is set to LR . Difference between the wavelength/frequency of the side modes on the left/right of the main mode.
Center Offset	Only if Algorithm is set to LR . Difference between the wavelength/frequency of the main mode and the middle of the stop band.

Setting Up OSNR Analysis

The OSNR analysis tool is available in **OSA**, **SML**, **WDM**, **RLT** and **OFA** analysis modes.

Defining OSNR Analysis Parameters

The **OSNR** tool allows you to get the calculated Optical Signal to Noise Ratio of a laser peak (in dB).

OSNR Calculation

IEC standard 61280-2-9

For data rates < 10 Gbits/s and for non-modulated signals, the calculation of the OSNR follows the equation defined in the IEC standard 61280-2-9:

$$OSNR = 10 \times \log\left(\frac{P_i}{N_i}\right) + 10 \times \log\left(\frac{RBW_{OSA}}{RBW_{ref}}\right) = 10 \log\left(\frac{P}{N_{corr}}\right)$$

Where:

- P_i is the optical power of the channel in Watts.
- N_i is the interpolated noise power in Watts measured in the resolution bandwidth of the OSA20.
- RBW_{OSA} is the resolution bandwidth of the OSA20.
- RBW_{ref} is the reference optical bandwidth, chosen to be 0.1 nm.
- N_{corr} is the noise correction:

$$N_{corr} = \left(\frac{N_i \times RBW_{ref}}{RBW_{OSA}}\right)$$

In case of OSA20, a correction factor is added to account for the Gaussian shape of the filtering, instead of the rectangular shape obtained at larger bandwidth.

$$10 \log\left(\frac{RBW_{OSA}}{RBW_{ref}} \times \sqrt{\frac{\pi}{4 \ln 2}}\right)$$

The standard also indicates that the calculation of N_i , usually not measurable due to the presence of the signal peak, needs to be done based on interpolation (i.e. a fit) of the noise spectrum close to the signal. You must note that the measured signal is in fact the sum of $P_i + N_i$.

Analyzing Traces

Setting Up OSNR Analysis

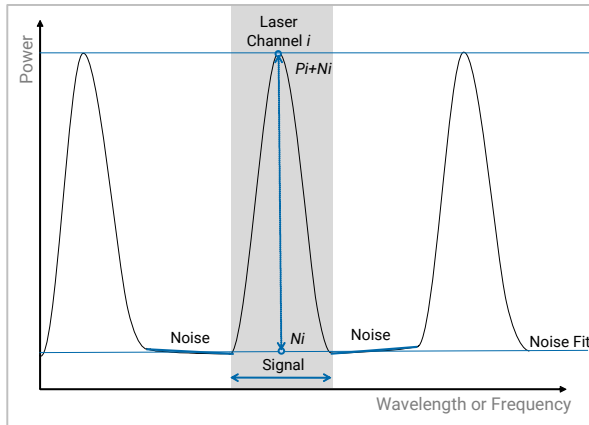

On-Off Method

For polarization multiplexed signals or signals > 40 Gbits/s data rates, the above interpolation method fails to find the relevant noise.

In this case, you should use the **On-Off Method** (only available in **WDM** and **RLT** analysis modes), which consists in taking two measurements of the WDM signal: one with all channels turned *on* and one with the channel of interest turned *off*.

The signal power is then calculated from the *on* trace and the noise power is calculated from the *off* trace. An integration of both powers is then performed for the calculation of the OSNR, still scaling the result to a resolution bandwidth of 0.1 nm:

$$OSNR = 10 \times \log \left[\frac{1}{RBW_{ref}} \times \int_{\lambda_{min}}^{\lambda_{max}} \frac{s(\lambda)}{p(\lambda)} d\lambda \right]$$

Where:

- The integration must be performed from λ_{min} to λ_{max} within the relevant channel (e.g. over 0.4 nm in case of a 50 GHz spaced signal).
- RBW_{ref} is the reference optical bandwidth, chosen to be 0.1 nm.
- The power $s(\lambda)$ is the signal power density, excluding the noise, expressed in mW/nm.
- The noise $p(\lambda)$ is the noise power density expressed in mW/nm.
- In case of OSA20, the integration is replaced by a sum of all signal and noise data points, spaced by $d\lambda = 2$ pm.

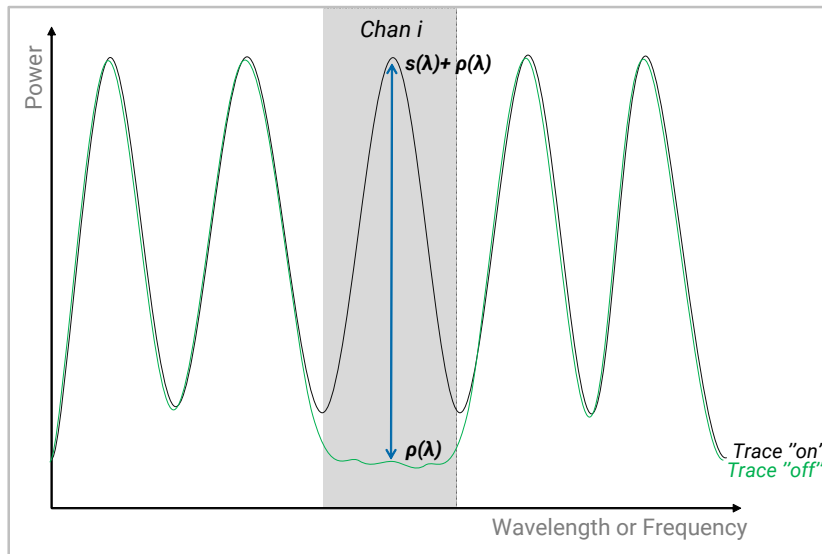

To use the OSNR analysis tool:

- 1.** If you want to use the **On-Off Method** (see **On-Off Method** on page 98):
 - 1a.** Make sure you have two measurements of the WDM signal (taken with the same resolution setting):
 - On **Trace 1**: one measurement with all channels turned on.
 - On any trace from Trace 2 to Trace 8: one measurement with the channel of interest turned off.
 - 1b.** In the **Analysis** menu, select the trace displaying the *off* measurement for analysis.
- 2.** In the analysis mode window, touch the **Analysis Setup** tab.
- 3.** Touch the **OSNR** tool and modify the parameters using the instructions given in the following *To define the OSNR parameters*: on page 100.
- 4.** In **OSA**, **SML** and **WDM** modes, activate the analysis calculation for the next analysis run by selecting the **Activate** check box.
In **OFA** mode, the tool is automatically activated.
- 5.** To make graphical display items of the analysis visible on the graph, select the **Display on Graph** check box.

To define the OSNR parameters:

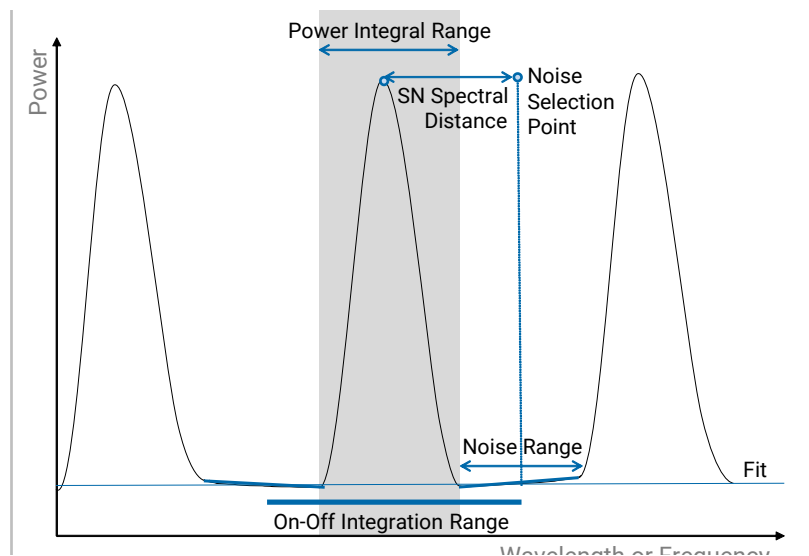

Noise Detection Settings

- **Noise Point Selection:** method to define the signal to noise spectral distance (with peaks or troughs detected with the PT Search tool).
 - The three following methods measure and calculate the signal power P_i based on **Power Integration** and **Power Integral Range**. The noise selection point is calculated to the left and right of the peak using the **Noise Point Selection**, which is used with the **Noise Range** to calculate the Noise Fit. The OSNR is then calculated using the equation described in **IEC standard 61280-2-9** on page 97.
 - Fixed** (OSA and SML analysis modes default): fixed distance value from the main peak, entered in the **SN Spectral Distance** field.
 - Nearest Peaks:** half the distance between the nearest peak and the main peak. If only one peak is detected, the **Nearest Troughs** method is used.
 - Nearest Troughs** (WDM and OFA analysis mode default): the nearest trough of the main peak.
 - **On-Off Method** (WDM and RLT analysis modes only): measures and calculates the signal (without noise) and noise power within the **On-Off Integration Range**. It integrates the signal/noise power and uses the On-Off Method equation (see **On-Off Method** on page 98) for the calculation of OSNR.
- **Noise Range** (only if **Noise Point Selection** is set to **Fixed**, **Nearest Peaks** and **Nearest Troughs**)

Width of the noise area around the **Noise Point Selection** used for the calculation of the noise fit N_i .

Default value (OSA and SML analysis modes): 0.2 nm / 0.024 THz

Default value (WDM and OFA analysis mode): 0.01 nm / 0.001 THz

- **On-Off Integration Range** (only if **Noise Point Selection** is set to **On-Off Method**)

Integration width of the **On-Off Method** in GHz. Make sure this value is identical to the **Grid Spacing** value selected in the Channel Detection tool (see *To define the Channel Detection parameters*: on page 70).

Default value: 12.5 GHz
- **SN Spectral Distance** (only if **Noise Point Selection** is set to **Fixed**)

The distance between the peak and the noise area, measured either side of the peak.

Default value: 0.5 nm / 0.060 THz
- **Fit** (only if **Noise Point Selection** is set to **Fixed**, **Nearest Peaks** and **Nearest Troughs**)

Fit to apply to the noise data for interpolation of the noise figure N_f :

 - **Linear** (default)
 - **3rd Order Polynomial**
 - **4th Order Polynomial**
 - **5th Order Polynomial**
 - **Gaussian**
- **Reference Optical BW (Bandwidth)**

RBW_{ref} in the calculation given in **IEC standard 61280-2-9** on page 97.

Default value: 0.1 nm (in accordance with IEC 6180-2-9) / 0.012 THz
- **BW Corrected Display**
 - : the noise to be displayed is corrected (N_{corr}), as explained in **IEC standard 61280-2-9** on page 97.
 - (default): the noise to be displayed is not corrected (N_f) as explained in **IEC standard 61280-2-9** on page 97.

Signal Detection Settings

- **Power Integration** (only if **Noise Point Selection** is set to **Fixed**, **Nearest Peaks** and **Nearest Troughs**):
 - (WDM analysis mode default): the signal power is integrated over the defined **Power Integral Range**.
 - (OSA, SML and OFA analysis modes default): the signal power is defined as the peak power.
- **Power Integral Range** (only if **Noise Point Selection** is set to **Fixed**, **Nearest Peaks** and **Nearest Troughs**, and if **Power Integration** check box is selected)

The range of integration of the signal around the peak signal.

Default value: 10 GHz

Analyzing Traces

Setting Up OSNR Analysis



- **Power Meter Display** (WDM analysis mode only)
 - (default): the detected signal is displayed on graph, if the **Display on graph** parameter of the **Channel Detection** tool is activated (see *Defining Channel Detection Analysis Parameters* on page 70).
 - : the detected signal is not displayed on graph.

Analyzing OSNR Results

Analysis results are displayed below the graph (see *Result Area Description* on page 64).

Results Displayed on Graph

If you have selected the Display on Graph check box, the following graphical items are displayed on graph:

-  is displayed on the signal power/wavelength.
-  is displayed on the noise power.

Result Area

Result	Meaning
Noise Level/BW Corrected Noise	OSA and SML analysis modes only. Value of the noise figure N_i or N_{corr} as interpolated with the fitting input parameters.
OSNR/ OSNR _{IN/OUT} (OFA)	Value of the OSNR as defined by the calculation given above in IEC standard 61280-2-9 on page 97 for OSA20.
P_{int}	WDM analysis mode only. Integrated power measurement within the Power Integral Range if the Power Integration check box is selected.
Noise/ Noise _{Corr}	WDM analysis mode only. Noise value (with or without bandwidth correction) at the wavelength of the signal, interpolated from the fit of the spectrum located in the Noise Range .
$P_{IN/OUT}$	OFA analysis mode only. Power level, without integration. This value takes into account the Input Attenuation/Output Attenuation parameters set in the Gain Settings (see <i>Defining Gain & NF Analysis Parameters</i> on page 109).
Noise _{IN/OUT}	OFA analysis mode only. Noise value, without correction. This value takes into account the Input Attenuation/Output Attenuation parameters set in the Gain Settings (see <i>Defining Gain & NF Analysis Parameters</i> on page 109).

Setting Up Ripple Analysis

The Ripple analysis tool is available in **OSA** and **BBS** analysis modes.

Defining Ripple Analysis Parameters

The **Ripple** tool allows you to get the calculated parameters of the ripple within a selected area (in nm) and after removal of the baseline.

To use the Ripple analysis tool:

1. In the analysis mode window, touch the **Analysis Setup** tab.
2. Touch the **Ripple** tool and modify the parameters using the instructions given in the following *To define the Ripple parameters:* on page 103.
3. Activate the analysis calculation for the next analysis run by selecting the **Activate** check box.

To define the Ripple parameters:

Ripple Measurement Settings

► **Detection Threshold**

Threshold for detection of ripple peaks and troughs once the baseline is removed after the fit (see *Analyzing Ripple Results* on page 104).

Default value: 0.01 dB

► **Span**

Spectral range around the main peak over which the ripple measurement is performed. It is recommended to set it larger than ten ripple periods. If **Span** is larger than the analyzed trace span, the calculation is performed on the analyzed trace span.

Default value: 10 nm / 1.209 THz

► **Refractive index**

In case of SLED, the ripple is caused by Fabry-Perot (FP) effect. To display the equivalent FP length estimated based on ripple frequency measurement, the refractive index of the material causing the ripple is required.

Default value: 1.00027326 (air @1550 nm)

Analyzing Ripple Results

Analysis results are displayed below the graph (see *Result Area Description* on page 64).

Result Description

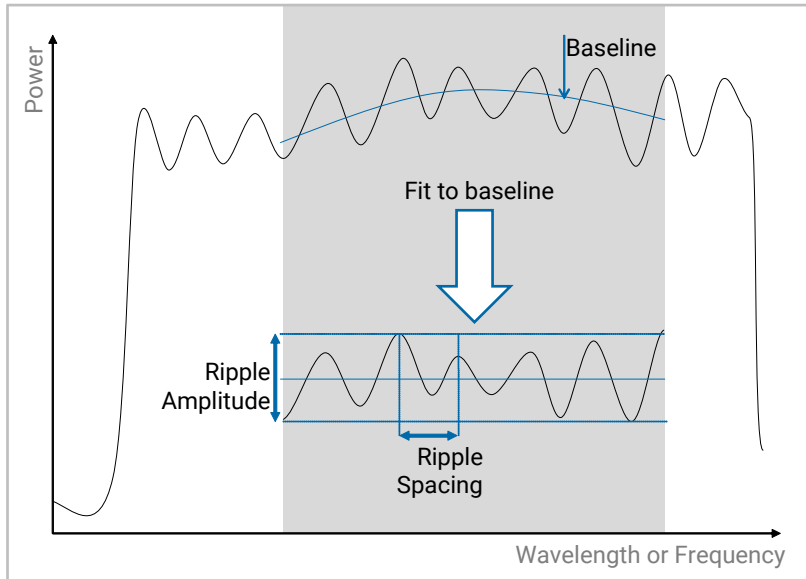

Result	Meaning
Amplitude	Measure difference between highest and lowest level of the ripple, after removal of the baseline.
Spacing	Mean spacing of measured ripple peaks above the detection threshold, after removal of the baseline.
Equivalent FP Length	Estimated Fabry-Perot length, based on ripple spacing and on the refractive index given as input.

Setting Up Optical Power Analysis

The Optical Power analysis tool is available in **OSA**, **BBS**, **MML** and **SML** analysis modes.

Defining Optical Power Analysis Parameters

The **Power** tool allows you to get the total power measured on the spectrum integrated over a selected spectral range.

Power Calculation

Power calculation, including offset:

$$\text{Total Power} = \text{Offset} + \Delta\lambda \times \sqrt{\frac{4\ln 2}{\pi}} \sum_1^{N_{\text{samples}}} \frac{P_i}{R_i}$$

Where:

- $\Delta\lambda$ is the sampling rate (in nm) of the trace.
- $\sqrt{\frac{4\ln 2}{\pi}}$ in the equation takes into account the Gaussian filtering response of the monochromator inside the OSA20.
- $\sum \frac{P_i}{R_i}$ is the sum of all the values of power (P_i) of the trace, in mW (conversion if needed) divided by the corresponding resolution bandwidth (R_i).

To use the Optical Power analysis tool:

1. In the analysis mode window, touch the **Analysis Setup** tab.
2. Touch the **Optical Power** tool and modify the parameters using the instructions given in the following *To define the Power parameters*: on page 106.
3. Activate the analysis calculation for the next analysis run by selecting the **Activate** check box.

Analyzing Traces

Setting Up Optical Power Analysis

To define the Power parameters:

Power Measurement Settings

➤ Noise Suppression

- (default): the Noise Suppression algorithm is used to reduce the dependence of the measurement to noise data.
- : the raw spectrum is used for the integration of power.

➤ Offset

Adds the entered value to the measured power.

Default value: 0 dB

➤ Full Span

- (default): the full spectrum is used for the integration of power.
- : enables you to enter a span value in the **Span** field.

➤ Span (only if the **Full Span** check box is cleared)

Span limits the computation of power to a span around the identified main peak wavelength/frequency.

Default value: 0.02 nm / 0.002 THz

Analyzing Optical Power / Gain / Loss Results

Analysis results are displayed below the graph (see *Result Area Description* on page 64).

Result Description

Result	Meaning
Total Power (dBm)	Power measured within the scan range in dBm. If no power (or negative power) is detected, the result displays -100 dBm.
Total Power (xW)	Power measured within the scan range in Watt, scaling automatically in pW, nW, uW, mW. If no power (or negative power) is detected, the result displays 0 mW.
Average Gain/Loss	Only for traces in dB. Average gain/loss measured within the scan range in dB.

Setting Up Loss Measurement Analysis

The **Loss Measurement** analysis tool is available in the **PCT** analysis mode, for **Fiber** component type. The analysis settings cannot be modified.

Defining Loss Measurement Analysis Parameters

The **Loss Measurement** tool allows you to get the average attenuation and the uniformity of a spectral trace obtained from a fiber-type passive component.

To use the Loss Measurement analysis tool:

1. In the **PCT** analysis mode window, touch the **Analysis Setup** tab.
2. Touch the **Component Selector** tool and set the **Type** parameter to **Fiber**.
3. The **Loss Measurement** tool will automatically be calculated on the next analysis.

To define the Loss Measurement parameters:

The analysis settings cannot be modified. For more details on measurement settings, see *Defining Optical Power Analysis Parameters* on page 105.

- **Noise Suppression:** disabled
- **Offset:** 0 dB
- **Full Span:** activated

Analyzing Loss Measurement Results

Analysis results are displayed below the graph (see *Result Area Description* on page 64).

Result Description

Result	Meaning
Average Loss	Only for traces in dB. Measured fiber attenuation, in dB.
Uniformity	Only for traces in dB. Difference between minimum and maximum loss within the analysis range, in dB.

Setting Up Peak Power Density Analysis

The **Peak Power Density** analysis tool is available in the **BBS** analysis mode.

Defining Peak Power Density Analysis Parameters

The **Peak Power Density** tool allows you to get the integrated power on 1 nm around the peak, or 1 THz, depending on the selected measurement unit (see *Setting Spectral and Power Units* on page 31).

To use the Peak Power Density analysis tool:

1. In the **BBS** analysis mode window, touch the **Analysis Setup** tab.
2. Touch the **Peak Power Density** tool and modify the parameters using the instructions given in the following *To define the Peak Power Density parameters* on page 108.
3. Activate the analysis calculation for the next analysis run by selecting the **Activate** check box.

To define the Peak Power Density parameters

Peak Power Density Measurement Settings

➤ Noise Suppression

- (default): the noise suppression algorithm is used to reduce the dependence of the measurement to noise data: any point with surrounding ± 10 pt below 0 mW is considered noise and set to 0 mW.
- : the raw spectrum is used for the integration of power.

➤ Offset

Adds the entered value to the measured power.

Default value: 0 dB

Analyzing Peak Power Density Results

Analysis results are displayed below the graph (see *Result Area Description* on page 64).

Result Description

Result	Meaning
Power Density (dBm/nm or dBm/THz)	Power density measured in dBm/nm or dBm/THz, depending on the selected measurement unit (see section Setting General Parameters, p. 22).
Power Density (μW/nm or μW/THz)	Power density measured in μ W (or pW, nW, mW)/nm or μ W (or pW, nW, mW)/THz, depending on the selected measurement unit (see section Setting General Parameters, p. 22).

Setting Up Gain and Noise Figure Analysis

The Gain and NF Analysis tool is available in the OFA analysis mode.

Defining Gain & NF Analysis Parameters

The **Gain and NF** tool calculates Gain and noise figure of an amplifier based on the OSNR results for both input and output signal of the amplifier.

To use the Gain & NF analysis tool:

1. In the OFA analysis mode window, touch the **Analysis Setup** tab.
2. Touch the **Gain and NF** tool and modify the parameters using the instructions given in the following *To define the Gain & NF Parameters:* on page 109.
3. To make graphical display items of the analysis visible on the graph, select the **Display on Graph** check box.

To define the Gain & NF Parameters:

Experimental Setup

Setup used for the calculation of the amplifier's gain and noise figure:

- **Single Source** (default): results are displayed in boxes in the Result area. This selection deactivates the **Channel Detection** tool.
- **Multichannel**: results are displayed in a table and on the graph in dB, **Gain** and **Noise Figure** are displayed as a function of wavelength. This selection activates the **Channel Detection** tool.

Gain Settings

Attenuation you want to apply on traces IN and/or OUT if necessary.



IMPORTANT

Traces are not shifted on the graph.

$$G = \frac{(P_{out} - SSE_{out}) L_{out}}{(P_{in} - SSE_{in}) L_{in}}$$

➤ Input Attenuation

Power difference L_{in} between power arriving at the amplifier input and power measured in trace IN.

Default value: 0 dB

➤ Output Attenuation

Power difference L_{out} between power at the amplifier output and power measured in trace OUT.

Default value: 0 dB

Noise Figure Settings

► Noise Figure Selection

Equation used for the calculation of the noise figure:

- **Full** (default): the following whole equation is used for the calculation.

$$NF = \frac{1}{G} + \frac{P_{ASE}}{h\nu \times G \times \Delta\nu} + \frac{P_{ASE} \times \Delta f}{P_{in} \times G^2 \times \Delta\nu} + \frac{P_{ASE}^2 \times \Delta f}{2 \times P_{in} \times h\nu \times G^2 \times \Delta\nu^2}$$

with filtering width $\Delta f = 0$, the equation simplifies to:

$$NF = \frac{1}{G} + \frac{P_{ASE}}{h\nu \times G \times \Delta\nu}$$

where:

h : Planck's constant: 6.626×10^{-34} (J.s).

ν : center frequency of the output signal.

$\Delta\nu$: frequency resolution of the OSA measured on the P_{in} signal or calculated from Calibrated data depending on **Resolution**.

G : gain at signal wavelength/frequency.

P_{ASE} : power of amplifier's ASE (amplified spontaneous emission)

P_{in} : power of input signal.

Δf : filtering width, is the bandwidth of the ASE around the signal, expressed in Hz.

- **Simplified**: the simplified version of the equation is used for the calculation, as it appears in the IEC standard 61290-3-1 (2003-08), where only the Signal to Spontaneous emission beating part is used:

$$NF = \frac{P_{ASE}}{h\nu \times G \times \Delta\nu}$$

► Resolution

The OSA monochromator resolution used for NF calibration:

- **Measured** (default): the FWHM of the detected signal is used.
- **Calibrated**: the resolution as measured at the calibration time is used.

► Filtering Width

Width (in GHz) of the filter centered around the signal wavelength.

If no filter is used, set this parameter to the width of the optical amplifier output used when **Noise Figure Selection** is set to **Full**.

Set this parameter to **0** to achieve simplified IEC equation with shot noise.

Default value: 0 GHz

Analyzing Gain and NF Results

Analysis results are displayed below the graph (see *Result Area Description* on page 64).

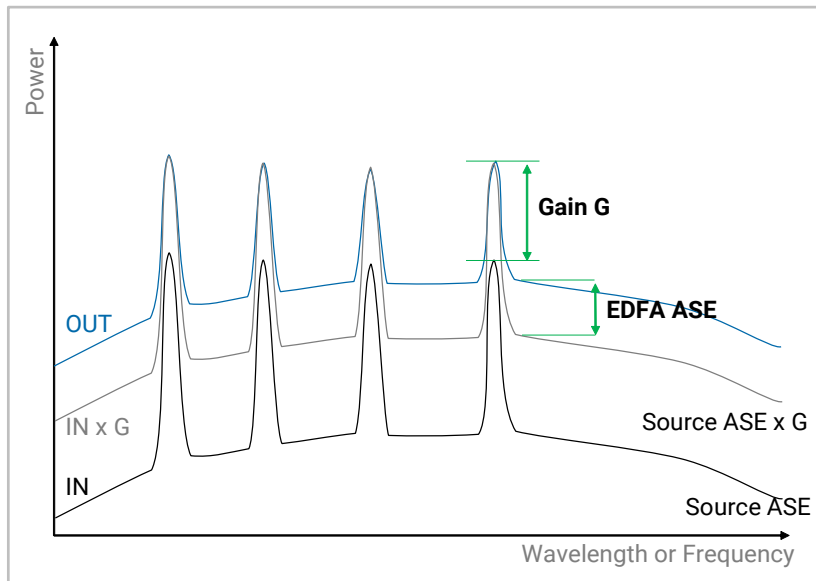

Results Displayed on Graph

If you have selected **Multichannel** in the **Experimental Setup** field, and if the **Display on Graph** check-box is selected, gain and noise figure are displayed on graph (with legend).

Result Area

Depending on the parameter selected in the **Experimental Setup** field, results are displayed in boxes grouped by analysis tool (**Single Source**), or in the form of a table of channels (**Multichannel**).

Result	Meaning
Res	Resolution used in the calculation of the EDFA noise figure.
Noise_{Amp}	Noise power measured at signal wavelength/frequency using output OSNR calculations.
Gain	Gain calculated from output and input signal power and output and input noise power (from OSNR calculation on trace IN and trace OUT).
NF	Noise figure calculated using PASE, EDFA Gain and Resolution. Depending on Noise Figure Selection (and filtering width), the equation for the calculation is simplified or contains all components.
OSNR_{Amp}	Optical signal to noise ratio of the output signal power to the ASE noise power (with the Reference Optical BW set in the OSNR tool output).
S	Ratio of signal output power to measured output power.

Analyzing Traces

Setting Up Gain and Noise Figure Analysis

In **Multichannel** experimental setup, the following results are available above the table:

- **Int. ASE_{OUT}**: integrated ASE noise power calculated from the integrated output spontaneous emission minus the input source spontaneous emission times the EDFA gain.
- **G Flat.:** gain flatness. It provides a comparison of minimum gain to maximum gain across all tested channels.
- **G Slope:** slope of a linear fit to all tested channel's gain.
- **G_{Avg}**: average gain obtained from all tested channel's gain.
- **Total P_{IN}**: power of input signal measured within the scan range.
- **Total P_{OUT}**: power of output signal measured within the scan range.

Setting Up Pass Band Test Analysis

The **Pass Band Test** analysis tool is available in the **PCT** analysis mode, for **Pass Band Filter** component type.

Defining Pass Band Test Analysis Parameters

The **Pass Band Test** tool allows you to get cross-talk, average loss, ripple and roll-off characteristics for a pass band filter.

To use the Pass Band Test analysis tool:

1. In the **PCT** analysis mode window, touch the **Analysis Setup** tab.
2. Touch the **Component Selector** tool and set the **Type** parameter to **Pass Band Filter**.
3. Touch the **Pass Band Test** tool and modify the parameters using the instructions given in the following *To define the Pass Band Test parameters:* on page 113.

The analysis tool is always activated.

4. To make graphical display items of the analysis visible on the graph, select the **Display on Graph** check box.

To define the Pass Band Test parameters:

CrossTalk Settings

► Reference

Reference point taken for the analysis of the characteristics of the filter:

- **Peak λ** (default): peak wavelength found in the **Spectral Width 1** tool results (see *Analyzing Spectral Width Results* on page 80).
- **Center λ** : center wavelength found in the **Spectral Width 1** tool results (see *Analyzing Spectral Width Results* on page 80).

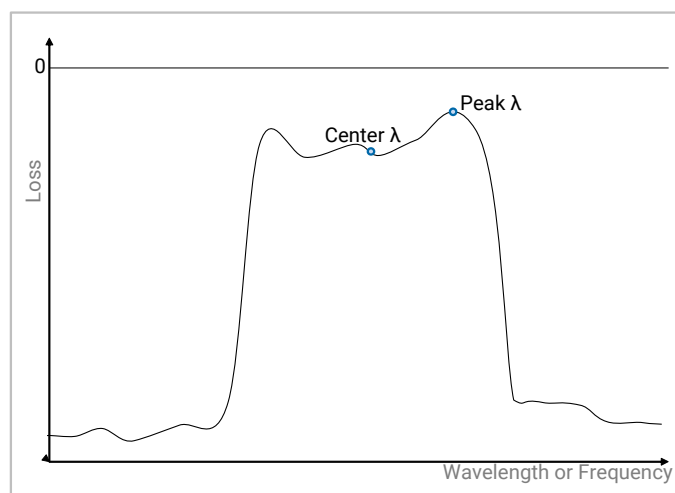

► IN/OUT Band Method

Method used in crosstalk calculation for the estimate of the spectral spacing between in and out bands:

Analyzing Traces

Setting Up Pass Band Test Analysis

- **Bandwidth 1** (default): selects the out band reference points to be exactly a bandwidth away from the in-band point, using the result in **Spectral Width 1** tool (see *Analyzing Spectral Width Results* on page 80).
- **Set Distance**: enables you to set the spacing via the **In/Out Band Distance** parameter.

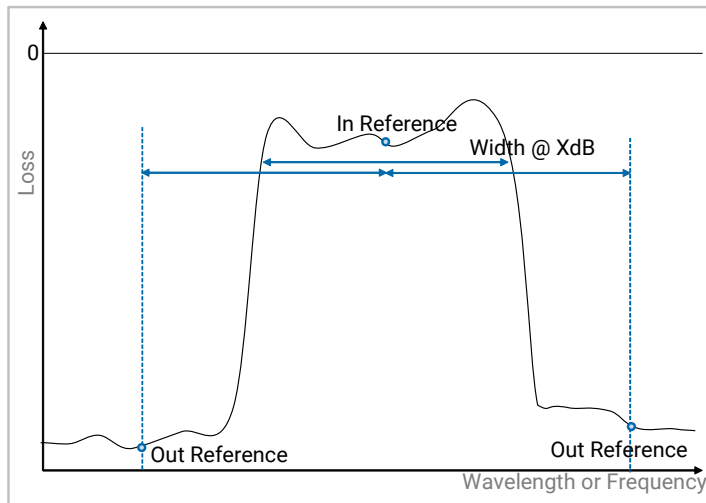

- **IN/OUT Band Distance** (only if **In/Out Band Method** is set to **Set Distance**)

Spectral spacing in nm/THz between the in-band reference point and the out-band reference points to be used for the crosstalk calculation. Default value: 1 nm

Average Loss & Ripple Settings

- **Averaging Range**

Spectral range used in the analysis of in-band and out-band average loss and ripple.

- **Fixed Range**: provides a fixed calculation span (see **Calculation Span** parameter),

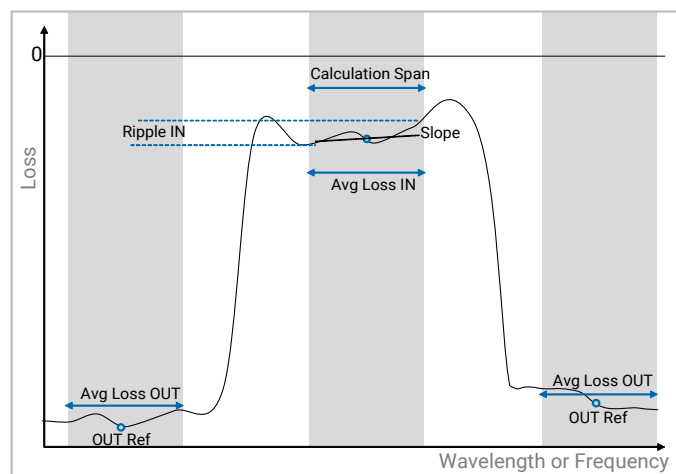

- **% Bandwidth**: sets the range to a fraction of the bandwidth measured from the **Spectral Width 1** tool (see *Analyzing Spectral Width Results* on page 80).

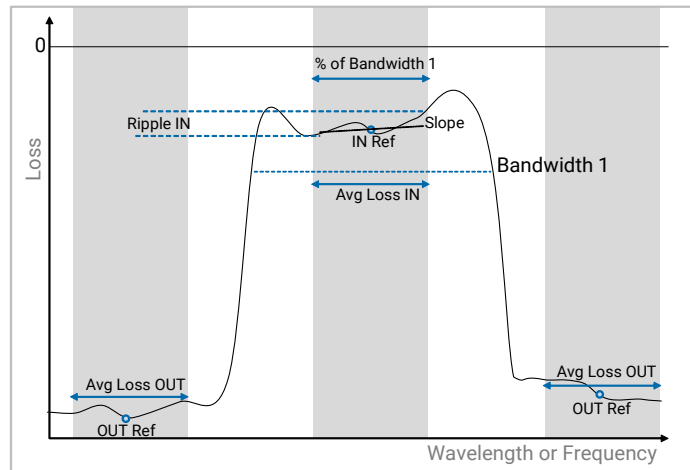

- **PT Detection:** detects all peaks and troughs within the Bandwidth 1 using **Detection Threshold**. The span is then set as the distance between the first and last peak detected for a pass band filter.

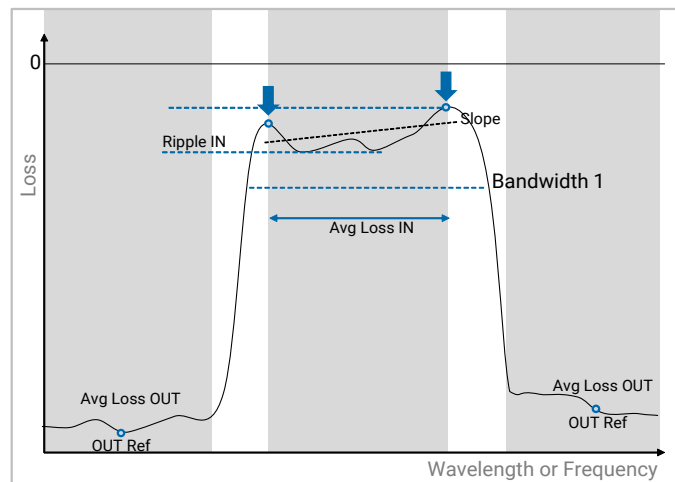

In-band and out-band average loss and ripple/slope calculations are performed across a given calculation span centered on their respective reference points as defined in crosstalk settings.

- **Calculation Span** (only if **Averaging Range** is set to **Fixed Range**)

Fixed Range in nm/THz over which calculations are done. The range is centered on the reference points for in-band and out-band (set in **CrossTalk Settings** on page 113). A range of 0 takes a single point for the calculation.

Default value: 0.1 nm

Analyzing Traces

Setting Up Pass Band Test Analysis

➤ **% Bandwidth** (only if **Averaging Range** is set to **% 3dB Bandwidth**)

Fraction (in %) of the bandwidth calculated in Spectral Width 1 over which calculations are done. The range is centered on the reference points for in-band and out-band (set in **CrossTalk Settings** on page 113).

Default value: 50 %

➤ **Detection Threshold** (only if **Averaging Range** is set to **PT Detection**)

Threshold in dB for the detection of in-band extreme peaks over which calculations are done. The range is centered on the reference points for out-band (set in **CrossTalk Settings** on page 113).

Default: 0.1 dB

Roll-Off & Transition Band Settings

➤ **Transition Reference**

Reference point to be used in the transition calculation:

- **In-Band** (default): the transition band is defined as the part of the trace between **Level@ Transition Reference - Min Exclusion Threshold** and **Level@ Transition Reference - Max Exclusion Threshold**.

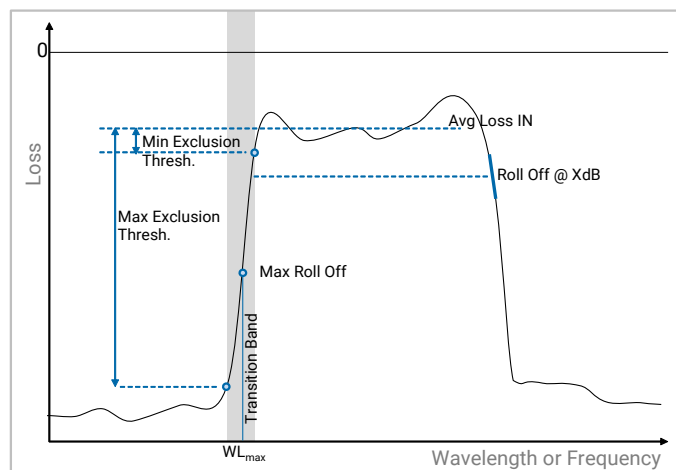

- **Out-Band**: the transition band is defined as the part of the trace between **Level@ Transition Reference + Min Exclusion Threshold** and **Level@ Transition Reference + Max Exclusion Threshold**

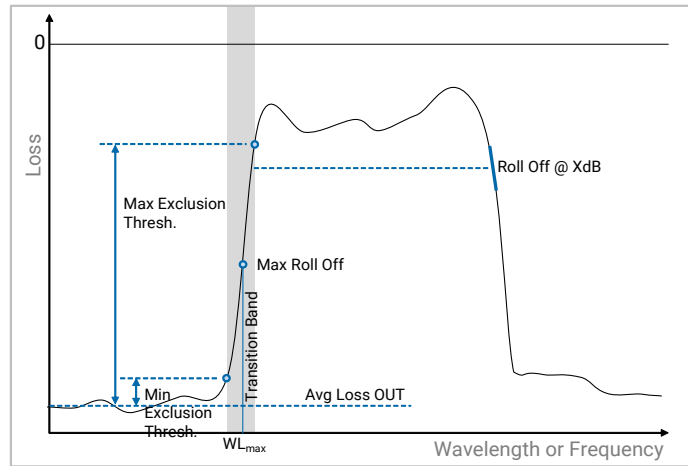

➤ **Min Exclusion Thresh.**

(in dB) Minimum threshold for the exclusion of data outside of the transition band.

Default value: 3 dB

➤ **Max Exclusion Thresh.**

(in dB) Maximum threshold for the exclusion of data outside of the transition band.



Default value: 20 dB

Analyzing Pass Band Test Results

Analysis results are displayed below the graph (see *Result Area Description* on page 64).

Results Displayed on Graph

If you have selected the Display on Graph check box, the following graphical items are displayed on graph:

-  are displayed on the reference points (in- and out-band).
-  are displayed on the maximum roll off wavelength within transition range.
-  are display on the transition range.

Result Area

The **RollOff** measurement is performed on the OSA20 trace, which is a convolution of the filter under test and the OSA20 monochromator.

➤ **In-Band Results**

Result	Meaning
Avg Loss	Average loss in dB measured across Averaging Range around the in-band reference point.
Ripple	Uniformity in dB as the min/max level difference measured within Averaging Range around the In-Band reference point.
Slope	Linear fit slope calculated within Averaging Range around the In-Band reference point.

Analyzing Traces

Setting Up Pass Band Test Analysis

► **Out-Band Side 1 Results & Out-Band Side 2 Results**

Result	Meaning
Avg Loss	Average loss in dB measured across Averaging Range around the Out-Band reference point.
Ripple	Uniformity in dB as the min/max level difference measured within Averaging Range around the Out-Band reference point.
CrossTalk	Crosstalk (pass band) in dB measured between the In-Band Reference point and the Out-Band reference point. Important: the crosstalk is given as difference between points, not between Avg Losses.
RollOff@XdB^a	Roll off in dB/nm (or dB/THz) measured at XdB (set by the Spectral Width 1 tool) from the Transition Reference point.
RollOff_{max}^a	Maximum roll off in dB/nm (or dB/THz), within the transition band.
λ @RollOff_{max}	Wavelength of maximum roll off in nm.
Transition Band^a	Wavelength region between Transition Reference +/- Minimum Threshold and Reference point +/- Maximum Threshold .

a. This result is calculated between the two reference points set in **CrossTalk Settings** on page 113.

Setting Up Stop Band Test Analysis

The **Stop Band Test** analysis tool is available in the **PCT** analysis mode, for **Stop Band Filter** component type.

Defining Stop Band Test Analysis Parameters

The **Stop Band Test** tool allows you to get isolation depth, average loss, ripple and roll-off characteristics for a pass band filter

To use the Stop Band Test analysis tool:

1. In the **PCT** analysis mode window, touch the **Analysis Setup** tab.
2. Touch the **Component Selector** tool and set the **Type** parameter to **Stop Band Filter**.
3. Touch the **Stop Band Test** tool and modify the parameters using the instructions given in the following *To define the Stop Band Test parameters:* on page 119.

The analysis tool is always activated.

4. To make graphical display items of the analysis visible on the graph, select the **Display on Graph** check box.

To define the Stop Band Test parameters:

Isolation Depth Settings

► Reference

Reference point taken for the analysis of the characteristics of the filter:

- **Trough λ** (default): peak wavelength found in the **Notch Width 1** tool results (see *Analyzing Notch Width Results* on page 91).
- **Center λ** : center wavelength found in the **Notch Width 1** tool results (see *Analyzing Notch Width Results* on page 91).

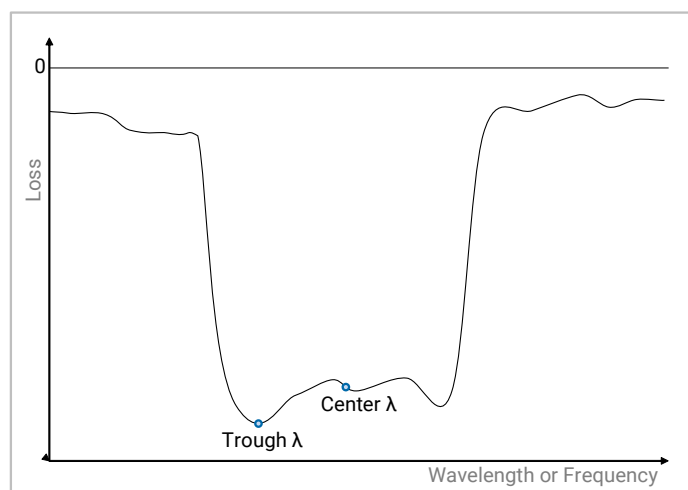

► IN/OUT Band Method

Method used in isolation depth calculation for the estimate of the spectral spacing between in and out bands:

Analyzing Traces

Setting Up Stop Band Test Analysis

- **Bandwidth 1** (default): selects the out band reference points to be exactly a bandwidth away from the in-band point, using the result in **Notch Width 1** tool (see *Analyzing Notch Width Results* on page 91).
- **Set Distance**: enables you to set the spacing via the **In/Out Band Distance** parameter.

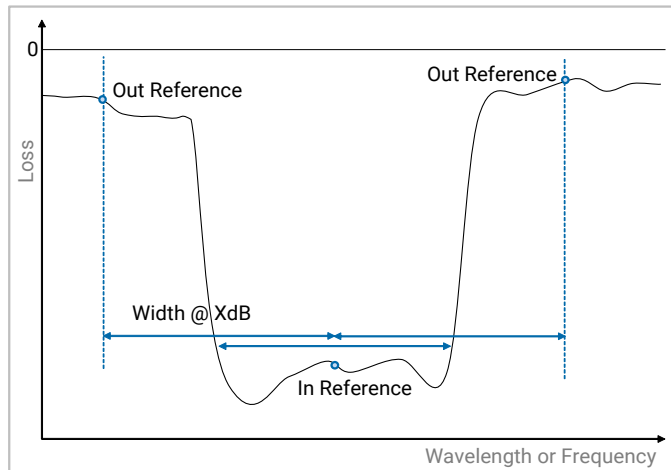

- **IN/OUT Band Distance** (only if **In/Out Band Method** is set to **Set Distance**)

Spectral spacing in nm/THz between the in-band reference point and the out-band reference points to be used for the isolation depth calculation.

Default value: 1 nm

Average Loss & Ripple Settings

- **Averaging Range**

Spectral range used in the analysis of In-band and out-band average loss and ripple.

- **Fixed Range**: provides a fixed calculation span (see **Calculation Span** parameter).

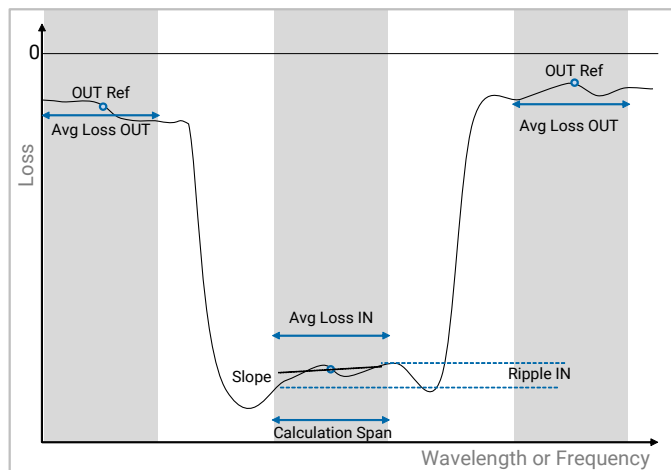

- **% Bandwidth:** sets the range to a fraction of the bandwidth measured from the **Notch Width 1** tool (see *Analyzing Notch Width Results* on page 91).

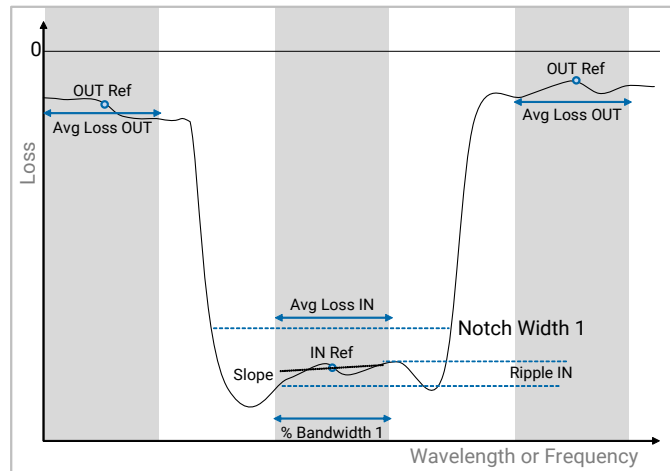

- **PT Detection:** detects all peaks and troughs within the Bandwidth 1 using **Detection Threshold**. The span is then set as the distance between the first and last trough detected for a stop band filter.

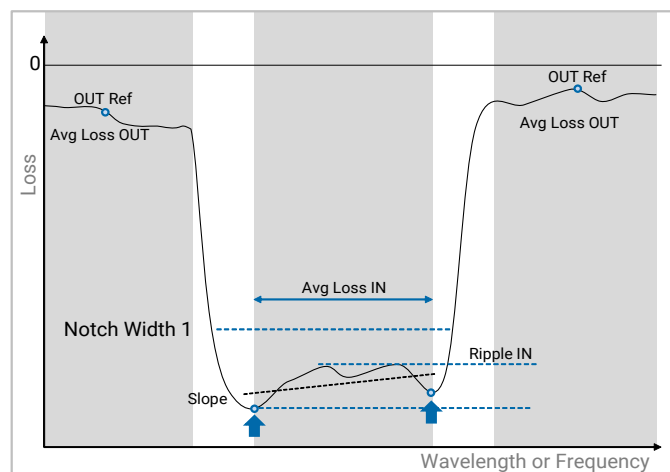

In-band and out-band average loss and ripple/slope calculations are performed across a given calculation span centered on their respective reference points as defined in isolation depth settings.

- **Calculation Span** (only if **Averaging Range** is set to **Fixed Range**)

Fixed Range in nm/THz over which calculations are done. The range is centered on the reference points for in-band and out-band (set in isolation depth settings). A range of 0 takes a single point for the calculation.

Default value: 0.1 nm

Analyzing Traces

Setting Up Stop Band Test Analysis

➤ **% Bandwidth** (only if **Averaging Range** is set to **% 3dB Bandwidth**)

Fraction (in %) of the bandwidth calculated in **Notch Width 1** over which calculations are done. The range is centered on the reference points for in-band and out-band (set in isolation depth settings).

Default value: 50 %

➤ **Detection Threshold** (only if **Averaging Range** is set to **PT Detection**)

Threshold in dB for the detection of in-band extreme troughs over which calculations are done. The range is centered on the reference points for in-band (set in isolation depth settings).

Default: 0.1 dB

Roll-Off & Transition Band Settings

➤ **Transition Reference**

Reference point to be used in the transition calculation:

- **In-Band** (default): the transition band is defined as the part of the trace between **Level@ Transition Reference - Min Exclusion Thresh.** and **Level@ Transition Reference - Max Exclusion Thresh.**

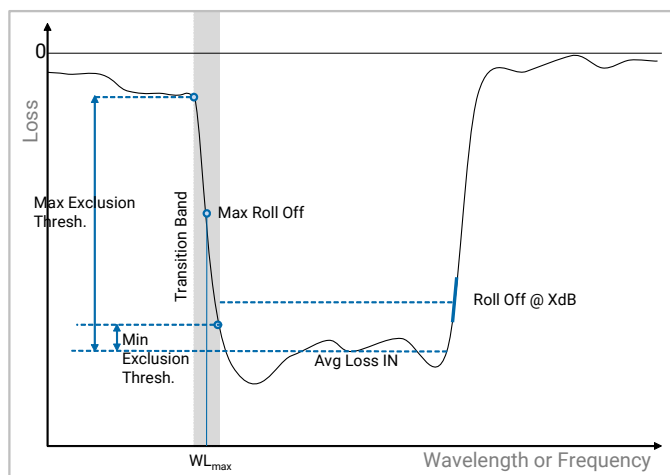

- **Out-Band**: the transition band is defined as the part of the trace between **Level@ Transition Reference + Min Exclusion Thresh.** and **Level@ Transition Reference + Max Exclusion Thresh.**

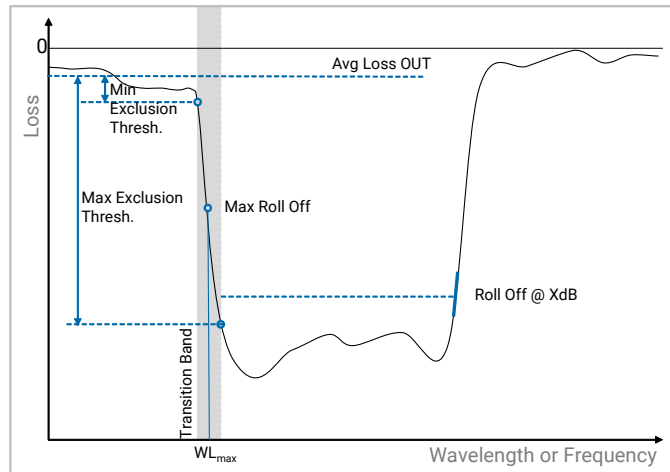



- **Min Exclusion Thresh.**
(in dB) Minimum threshold for the exclusion of data outside of the transition band.
Default value: 3 dB
- **Max Exclusion Thresh.**
(in dB) Maximum threshold for the exclusion of data outside of the transition band.
Default value: 20 dB.

Analyzing Stop Band Test Results

Analysis results are displayed below the graph (see *Result Area Description* on page 64).

Results Displayed on Graph

If you have selected the Display on Graph check box, the following graphical items are displayed on graph:

-  are displayed on the reference points (in- and out-band).
-  are displayed on the maximum roll off wavelength within transition range.
-  are display on the transition range.

Result Area

➤ In-Band Results

Result	Meaning
Avg Loss	Average loss in dB measured across Averaging Range around the In-band reference point.
Ripple	Uniformity in dB as the min/max level difference measured within Averaging Range around the In-Band reference point.
Slope	Linear fit slope calculated within Averaging Range around the In-Band reference point.

Analyzing Traces

Setting Up Stop Band Test Analysis

► Out-Band Side 1 Results & Out-Band Side 2 Results

Result	Meaning
Avg Loss	Average loss in dB measured across Averaging Range around the Out-band reference point.
Ripple	Uniformity in dB as the min/max level difference measured within Averaging Range around the Out-Band reference point.
Isolation Depth	Isolation depth in dB measured between the In-Band Reference point and the Out-Band reference point. Important: the isolation depth is given as difference between points, not between Avg Losses .
RollOff@XdB	Roll off in dB/nm (or dB/THz) measured at X dB (set by the Notch Width 1 tool) from the Transition Reference point.
RollOff_{max}	Maximum roll off in dB/nm (or dB/THz), within the transition band.
λ @RollOff_{max}	Wavelength of maximum roll off in nm.
Transition Band	Wavelength region between Transition Reference +/- Minimum Threshold and Reference point +/- Maximum Threshold .

Setting Up Mask Test Analysis

The **Mask Test** analysis tool is available in the **PCT** analysis mode, for all component types. This tool allows you to compare the transfer function trace to a specified mask and get the pass/fail result.

Defining Mask Test Analysis Parameters

The **Mask Test** tool allows you to define your optical component target specification as a mask.

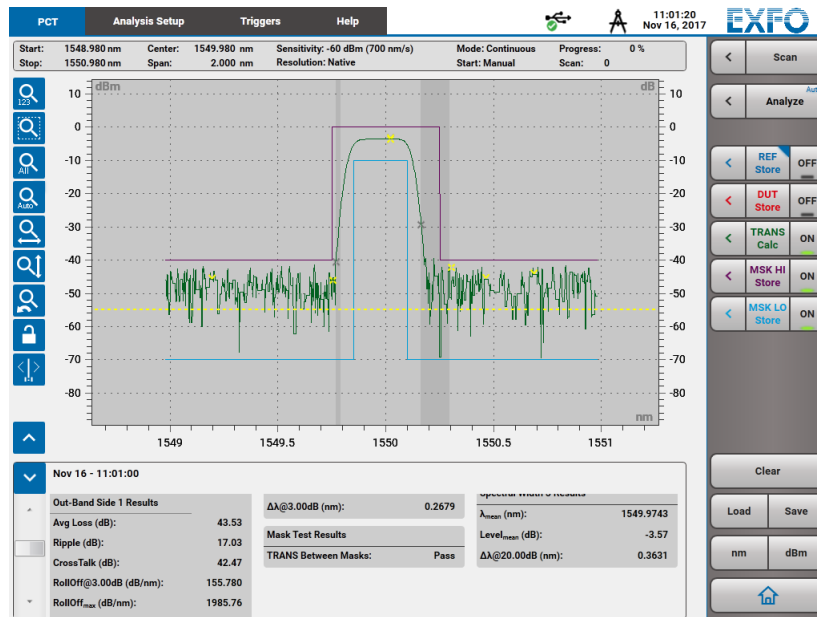

To use the Mask Test analysis tool:

1. Prepare and save the traces you want to set as high and low masks, which reflect your target specifications: one trace to feature the high mask and one trace to feature the low mask.

You can acquire these traces using the OSA20 or prepare them in .csv files.



IMPORTANT

The wavelength/frequency range of the mask traces must be higher than or equal to the wavelength/frequency range of the transfer function trace that is analyzed.

2. In the **PCT** analysis mode window, touch the  button located to the left of the **MSK HI** button to define the top mask trace.
3. The Trace MSK HI menu appears.

Analyzing Traces

Setting Up Mask Test Analysis

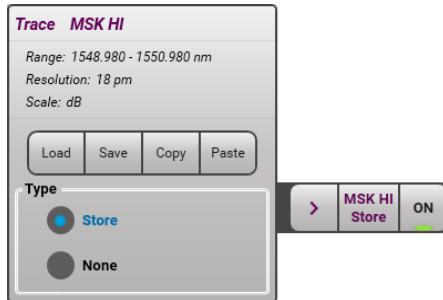

4. Touch the **Load** button and select the trace you want to set as high mask.
5. Set the trace to **Store**, and make sure the trace is set to **ON**.

The loaded trace is displayed on graph.

6. Perform steps 1 to 3 with **MSK LO** trace to define the low mask trace.

Analyzing Mask Test Results

Analysis results are displayed below the graph (see *Result Area Description* on page 64).

Result	Meaning
TRANS Between Masks	Alignment of the transfer function within the mask limits: <ul style="list-style-type: none">➤ Pass: the transfer function trace is within the high and low limits of the mask.➤ Fail LO: the transfer function runs over the low limit of the mask.➤ Fail HI: the transfer function runs over the high limit of the mask.➤ Fail HI/LO: the transfer function runs over the high and low limits of the mask.➤ No Masks: no mask is defined.➤ Mask size error: the wavelength/frequency range of the mask traces is lower than the wavelength/f

8 Handling Files and User Data

You can access the OSA20 internal drive or an external hard drive connected to the OSA20 to handle the content you want to save.

Connecting/Disconnecting USB Storage Devices

You can connect storage USB devices to the USB 2.0-A and USB 3.0-A ports located on the front and right-side panels of the OSA20 (see *Product Overview* on page 4).

To connect USB storage devices:

Connect the USB storage device to one of the available USB ports (you do not need to restart the OSA20).

- The first time you connect a USB storage device, the driver is installed and can take some time (depending on the connected device).
- The  icon appears at the left of the date and time and the device becomes available for loading or saving data and enables you to safely remove it (see *Connecting/Disconnecting USB Storage Devices* on page 127).

To disconnect USB storage devices from the OSA20

If you connect one or more USB storage device(s) to the OSA20, an icon appears on the top right of the screen, next to the date and time.

This icon enables you to safely remove USB storage devices from the OSA20, as explained in the following procedure.

1. On the OSA20 screen, touch the  icon located at the left of the date and time.
The list of all connected USB storage devices appears.
2. Touch the **Safely remove...** menu.
A confirmation message appears.
3. Remove the USB device from the OSA20.

Saving Analysis Settings and Results

You can save all the measurement parameters, analysis parameters set for the analysis mode, analysis results and screen shots of the displayed window, as explained in the following procedure.

Saving the configuration at the end of a test session enables you to start the next test session with exactly the same configuration.

To save analysis settings and results

1. If necessary, connect the device on which you want to save your parameters and/or results to one of the USB ports.
2. In the **<Analysis Mode>** tab, touch the **Save** button located in the configuration area.
The **Save** window appears. All connected drives are displayed.

Handling Files and User Data

Saving Analysis Settings and Results

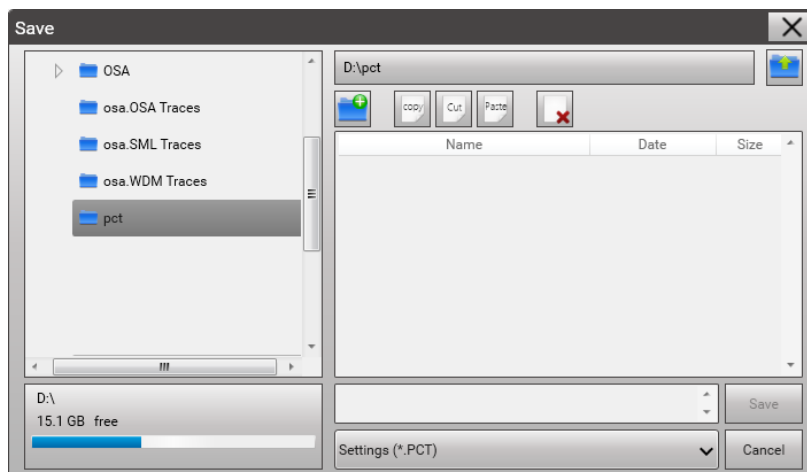

3. Touch the wanted drive and folder.
4. If you want to create a new folder: touch the  button and type a name for the folder (using the on-screen keyboard or a normal keyboard if connected to the OSA20), and touch the **Create** button.
5. Select the type of file to save:
 - **Settings (*.<analysis mode>)**: saves all the measurement and analysis parameters set for the analysis mode in the <filename>. <analysis mode> file, and all the traces in their current state in the .tra format in a separate folder with the same name as the settings file.
 - **Analysis Results (*.csv)**: saves the analysis results in a .csv file. You cannot load analysis results back to the system.
 - **Screenshot (*.jpg)**: save the displayed window in .jpg format.
 - **Screenshot (*.png)**: save the displayed window in .png format.
6. Type a name for the file: touch the text box at the left of the **Save** button to display the keyboard.
7. Touch the **Save** button.

A confirmation message appears.
8. Safely remove the USB device (if any) as explained in *Connecting/Disconnecting USB Storage Devices* on page 127.

Loading Measurement and Analysis Settings

You can restore measurement and analysis parameters you have previously saved, or the default measurement and analysis parameters set for an analysis mode.

To load previously saved settings

- 1.** If necessary, connect the device from which you want to load your parameters to one of the USB ports.
- 2.** In the **<Analysis Mode>** tab, touch the **Load** button located in the configuration area.
The **Open** window appears. All connected drives are displayed.
- 3.** Select the file to load and touch the **Open** button.
A confirmation message appears.
- 4.** Safely remove the USB device (if any) as explained in *Connecting/Disconnecting USB Storage Devices* on page 127.

To load the default measurement settings

- 1.** In the configuration area of the wanted analysis mode, touch the **Load** button.
The **Open** window appears.
- 2.** In the drop-down list, select **Default Settings** and touch the **Open** button.

Handling Files Saved

You can access the OSA20 internal drive or an external hard drive connected to the OSA20 to handle the settings and screen shot files you have saved. You can move the files from one location to another, for example to copy a file saved on the internal drive to an external USB device. You can also delete files you have previously saved on the internal drive.

To delete a file/folder

1. If necessary, connect to one of the USB ports the device from which you want to delete the file.
2. In the **<Analysis Mode>** tab, touch the **Save** or **Load** button located in the configuration area.

The Save or Open window appears.

3. Select the file(s) or folder(s) you want to delete and touch the  button.

The file(s)/folder(s) are deleted from the OSA20 internal drive.

To copy/cut-paste a file

1. If necessary, connect to one of the USB ports the device on which you want to copy/cut or paste the file.
2. In the **<Analysis Mode>** tab, touch the **Save** or **Load** button located in the configuration area.
The Save or Open window appears.
3. Select the file(s) you want to copy, cut or paste and touch the button corresponding to the action you want to perform: **Copy** or **Cut** button.
4. Select the drive and folder in which you want to paste the selected file(s) and touch the **Paste** button.

Deleting all User Data from the OSA20 Internal Drive

You can delete all data saved by a user on the internal OSA20 drive D:\. All user customized settings, parameters and traces displayed on screen will not be deleted.

To delete all user data from the OSA20 internal drive:

1. In the OSA20 home window, touch the **Settings** button.

The **Settings and Data Management** area enables you to delete user data on drive.

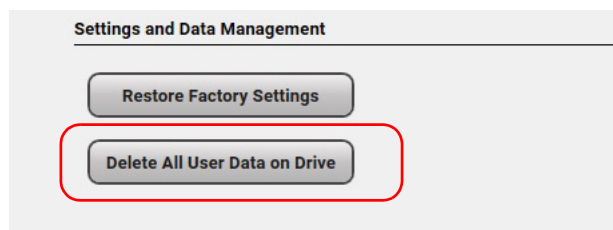

2. Touch the  button to go back to the OSA20 home window.

Restoring Factory Settings

Restoring factory settings deletes all the user customized settings, parameters and traces displayed on screen in the entire OSA20 system and restores the original default settings.

To restore factory settings:

1. In the OSA20 home window, touch the **Settings** button.

The **Settings and Data Management** area enables you to restore the factory settings.

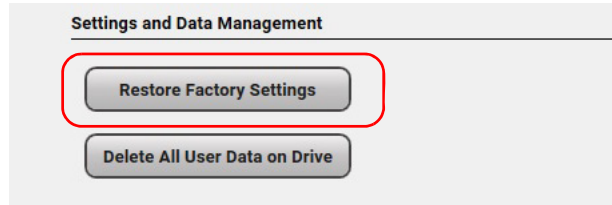

2. Touch the  button to go back to the OSA20 home window.

9 Using the OSA20 in Remote Control

You can remotely control the OSA20 by using one of the following ports:

- The GPIB port, located on the rear panel (see *Rear Panel* on page 9).
- The two Ethernet ports, located on the connector panel (see *Right-side Panel: Connectors* on page 6).
- The USB 2.0-B port, located on the connector panel (see *Right-side Panel: Connectors* on page 6).

Maximum transfer rates are available in *Interfaces and Electrical* on page 3.

The present section explains how to connect an external device for remote control, and set the remote control parameters. All remote commands and functions are detailed in *OSA20 Programming Guide*.

Preparing the OSA20 for Remote Control

Setting the GPIB Address

If you want to remotely control the OSA20 through the IEEE 488 port, you can modify the GPIB address.

The default GPIB address is 10. You can set it out between 1 and 30.

To modify the GPIB address

1. On the OSA20 home window, touch the **Remote** button.

The **Remote** window appears.

2. In the **GPIB** area, specify the GPIB address: touch the **Address** field and enter the wanted address value.

Setting the Ethernet Ports

The two Ethernet ports available on the OSA20 are dedicated to remote control of the instrument from a computer directly connected to the OSA20 (Ethernet port 1), or through your company network (Ethernet port 2).

If you want to use the **Ethernet port #1**, make sure the IP connection properties of your computer are properly configured, with the **Obtain an IP address automatically** parameter.

To set the Ethernet port:

1. On the OSA20 home window, touch the **Remote** button.

The **Ethernet** area enables you to configure the Ethernet connection of the OSA20.

Using the OSA20 in Remote Control

Preparing the OSA20 for Remote Control

The screenshot shows the EXFO OSA20 configuration interface. The 'Remote' tab is selected, showing a GPIB address of 10. The 'Ethernet' tab is also visible, containing a 'TCP Socket' section with a port of 5025. Below this, 'Port 1 (Left) - DHCP server' is shown with a connection speed of 100.0 Mbps and is configured as a DHCP server (192.168.54.1). 'Port 2 (Right)' is shown with a connection speed of 1.0 Gbps. The 'Obtain an IP address automatically' checkbox is checked. IP Address is 172.31.12.57, Subnet Mask is 255.255.255.0, and Default Gateway is 172.31.12.2. 'Refresh' and 'Apply' buttons are at the bottom of the Ethernet section.

: indicates that the connection is established and displays the connection speed.

: indicates that the connection to the external device is not established.

: indicates that the port is not connected to any external device.

2. In the **Ethernet** area, in the TCP Socket **Port** field, specify the TCP destination port to be used by the socket to allow data transmission between the OSA20 and the external controller.

Default value: 5025 (SCPI-RAW)



IMPORTANT

Make sure the firewall of your computer allows communication on this port.

3. Connect an RJ45 cable to the wanted port:
 - Use **Port 1 (left)** to remotely control the OSA20 from a computer by directly connecting it to the OSA20.
This port provides an automatic IP address configuration.
The **Port 1 (left)** area displays the address automatically assigned to the connected OSA20. Default OSA20 IP address: 192.168.54.1
 - Use **Port 2 (right)** to remotely control the OSA20 from a computer through your company network, or to directly connect a computer to the OSA20 and manually configure the connection parameters.

4. To manually set the connection parameters (only with **Port 2**):
 - 4a. In the **Port 2** area, clear the **Obtain an IP address automatically** check box.
 - 4b. Set the IP address, subnet mask and gateway to identify your OSA20.
5. To automatically retrieve the connection parameters (IP address, subnet mask and default gateway) from the connected network (DHCP): in the **Port 2** area, select the **Obtain an IP address automatically** check box.

The connection is automatically established. You cannot modify the connection values.
6. Touch the **Apply** button to validate the connection parameters you have set.
7. If you want to retrieve the previously applied connection parameters, click the **Refresh** button.

Installing the USB Driver on the Remote Computer

To remotely control the OSA20 through the USB-B port, you must install the EXFO USB driver on the computer from which you want to control the OSA20.

- Make sure your computer runs one of the following operating systems: Windows 7, Windows 8 or Windows 10.

If not, the OSA20 USB driver is not supported by your computer.
- Make sure you have the appropriate USB driver: the EXFO USB driver is provided on the USB key delivered with the OSA20, or can be downloaded from the EXFO website.
- Make sure you have a USB-A to USB-B cable.

To install the EXFO USB driver on your computer:

1. Do one of the following:
 - Connect the OSA20 USB key to the USB-A port of your computer.
 - From the EXFO website (www.EXFO.com/en/exfo-apps), download the OSA20 USB driver and unzip it to a temporary folder on your computer.
2. Connect your computer to the OSA20 by using a USB-A to USB-B cable.

The first time you connect the OSA20 to your computer, it prompts you to install the driver.
3. Select the **siusbxp.inf** file located in the **USB Driver\OSA20 USB Driver** folder and install the driver by following the instructions displayed on screen.

Entering/Exiting the Remote Mode

You can connect external devices without turning off the OSA20. Once the OSA20 has entered a remote mode (GPIB, USB-B or Ethernet), it can not receive commands from an other port.

- Make sure you have the appropriate cable:
 - For GPIB: IEEE 488 cable.
 - For Ethernet: RJ45 cable.
 - For USB-B: USB-A to USB-B cable.
- If you want to remotely control the OSA20 via USB:
 - Make sure the EXFO USB driver is installed on your computer (see *Installing the USB Driver on the Remote Computer* on page 135 for details).
 - EXFO provides a .dll and a LabVIEW driver allowing you to send commands via the USB port. See *OSA20 Programming Guide* for details.

To enter the remote mode:

1. Connect the external controller to the appropriate connector:
 - For GPIB: the GPIB port located on the rear panel of the OSA20 (see *Rear Panel* on page 9).
 - For Ethernet: one of the two available Ethernet port located on the right side panel of the OSA20 (see *Right-side Panel: Connectors* on page 6).
 - For USB-B: the USB 2.0-B port located on the right side panel of the OSA20 (see *Right-side Panel: Connectors* on page 6)
2. Make sure the port you want to use for remote control is properly configured: see *Preparing the OSA20 for Remote Control* on page 133.
3. Send a command from the remote controller.

When the OSA20 receives a command from an external controller, it enters the remote mode: the multi-touch screen is automatically deactivated and the **Local** button appears at the bottom right of the screen.

To exit the remote mode:

To get back to the local control of the OSA20, touch the **Local** button displayed at the bottom right of the screen.

The multi-touch screen is now available and you can use it. The local actions performed will be taken into account when another remote command will be received by the OSA20.

The OSA20 switches back to remote mode as soon as it receives a command.

10 Performing Basic Maintenance Operations

To help ensure long, trouble-free operation:

- Always keep the unit and its surroundings clean, free of dust and dirt, even if you are not using it.
- Keep the unit free of dust.
- Clean the unit casing and front panel with a cloth slightly dampened with water.
- Store the unit at room temperature in a clean and dry area, free of dust and out of direct sunlight.
- Avoid high humidity or significant temperature fluctuations.
- Avoid unnecessary shocks and vibrations.
- If any liquids are spilled on or into the unit, turn off the power immediately, disconnect from any external power source and let the unit dry completely.



WARNING

The use of controls, adjustments and procedures, namely for operation and maintenance, other than those specified herein may result in hazardous radiation exposure or impair the protection provided by this unit.

Cleaning the OSA20

Cleaning the Cover of the OSA20

If the external cover of the OSA20 becomes dirty or dusty, clean it by following the instruction below.



CAUTION

Do not use chemically active or abrasive materials to clean the OSA20.

Material needed:

- Cleaning cloth
- Isopropyl alcohol

To clean the external cover of the OSA20:

1. Turn the OSA20 off (see *Turning off the OSA20* on page 27) and unplug the power supply cable from the wall socket.
2. Slightly damp the cloth with an isopropyl alcohol liquid and gently swipe dirt and dust on the external cover of the OSA20, without applying excessive force onto it.

Cleaning the Fan Grids

To ensure proper cooling of the OSA20 from the fan, the fan grid must not be dusty, you must clean it regularly.



CAUTION

Do not use a vacuum cleaner to clean the fan as this may apply excessive force to it and cause damage to the fan.

To clean the fan grids:

1. Turn the OSA20 off (see *Turning off the OSA20* on page 27) and unplug the power supply cable from the wall socket.
2. Using a duster or a slightly moist cloth, gently clean the external grid of the fan without pressing it.

Cleaning the Multi-touch Screen

To ensure proper functioning and accuracy of the multi-touch screen, you must clean it regularly.

Material needed:

- Lint-free cleaning cloth
- Isopropyl alcohol

To clean the multi-touch screen:

1. Turn the OSA20 off (see *Turning off the OSA20* on page 27) and unplug the power supply cord from the wall socket.
2. Using an lint-free cloth slightly dampened with isopropyl alcohol, gently swipe dirt on the screen.
3. Make sure to avoid drops and prevent alcohol from entering the OSA20.

Cleaning Optical Connectors

To ensure measurement accuracy and prevent loss of optical power, you must verify that optical connectors are clean every time you connect a fiber.



IMPORTANT

To reduce the need for cleaning, immediately replace protective caps on the optical connectors when not in use.

The OSA20 optical connectors are mounted on a removable plate to ease the cleaning of internal connectors.

Before Starting

Make sure you have the following material:

- Optical grade cleaning cotton swabs
- Canned air
- Isopropyl alcohol
- Fiberscope or similar if available
- Lint-free tissue or cleaning cartridges

To clean the optical connectors:

1. Turn the OSA20 off (see *Turning off the OSA20* on page 27) and unplug the power supply cord from the wall socket.
2. On the front panel, make sure the protective caps of the connector's plate are in place.
3. On the front panel, use your fingers to unscrew the two screws of the connector plate.



CAUTION

Do not drop the connectors plate as the weight could damage the fiber.

Once unscrewed from the front panel, the two screws stay attached to the plate.

4. Gently pull the plate out of the front panel (no more than 70 mm) so that fiber ends are made visible, as illustrated in the following figure.

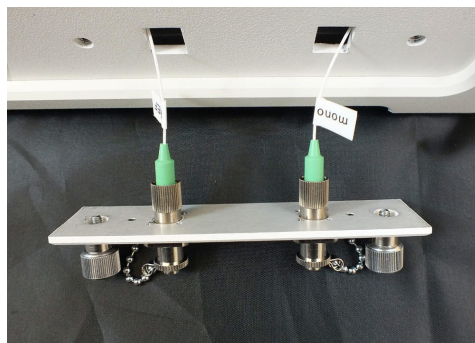

Performing Basic Maintenance Operations

Performing a User Calibration

5. At the rear of the plate, remove one connector end from the plate:
 - For FC connectors, unscrew the connector end from the plate.
 - For SC connectors, pull out the connector end from the plate.
6. Gently clean the connector end, with the following instructions:
 - 6a. Hold the can of compressed air upright and spray the can into the air to purge any propellant.
 - 6b. Spray the clean compressed air on the connector to remove any loose particles or moisture.
 - 6c. Moisten a clean optical swab with isopropyl alcohol and lightly wipe the surfaces of the connector with gentle circular motion.
 - 6d. Spray the clean compressed air on the connector again to remove any loose particles or isopropyl alcohol.
 - 6e. Check that the connector is clean with a fiberscope (or similar).
7. Replace the connector end at the rear of the plate: make sure the key of the connector is mated with that of the adapter and screw or push it back (depending on the connector type).
8. Perform steps 5 to 7 on the second connector.
9. Replace the connector's plate on the front panel:
 - 9a. Gently place fibers and labels into the hole on the front panel.
 - 9b. Screw the plate back it in its location, making sure no fiber is trapped between the front panel and the plate.

Performing a User Calibration

The user calibration application enables you to calibrate the OSA20 wavelength (not the power). It is available from the home window.

To make sure the OSA20 meets the applicable specifications, you must perform a user calibration in the following cases:

- You are using the OSA20 for the first time.
- The OSA20 has changed location or environment.
- The temperature of the room has changed by more than 3 °C.
- The OSA20 has been user calibrated before the one-hour warm-up at constant room temperature.
- The  icon is displayed in the Analysis Mode windows (see *Accessing an Analysis Mode* on page 33).

This icon is displayed in the following cases:

- Every time the OSA20 is turned on.
- If the temperature has changed too much since the last calibration.

The OSA20 has a built-in light source (**Calibration Output**), which is safe under normal conditions of use. The built in source is switched off if not in calibration mode.

For details on the acetylene gas cell, see *Technical Specifications* on page 1.

To perform a user calibration:

1. Make sure the room temperature is stabilized, and the OSA20 is at room temperature.
2. Make sure the OSA20 has been turned on at least for one hour. The user calibration process must only be performed after at least one hour warm-up.
3. Make sure the calibration output and optical input connectors are perfectly clean (see *Cleaning Optical Connectors* on page 139).
4. In the OSA20 home window, touch the **Calibration** button.
5. Remove the **Calibration Output** and the **Optical Input** protective covers.
6. On the front panel, connect the appropriate patch cord (corresponding to the connector type mounted on your product) between the **Calibration Output** and the **Optical Input**, and follow the instructions displayed on screen.

If an error message occurs, see *User Calibration Error Messages* on page 145 for instructions.

The user calibration process takes approximately 45 seconds.

Replacing the External Power Fuse

You must verify the power fuse in case you cannot turn on the OSA20.



WARNING

To avoid fire hazard, only use the correct fuse type, voltage and current ratings.

Make sure you have the following equipment:

- 1 slot screwdriver (4 to 6 mm).
- 1 replacement fuse (for fuse type, see *Technical Specifications* on page 1).

To replace the power fuse:

1. Turn the OSA20 off (see *Turning off the OSA20* on page 27) and unplug the power supply cord from the wall socket.
2. Unplug the cord of the adapter from the 48 V connector.
3. Insert the screwdriver in the fuse holder notch and unscrew the fuse holder from its housing.
4. Pull out the defective fuse from the fuse holder and replace it with the new one.
5. Replace the fuse holder in its housing on the rear panel and screw it back.
6. Plug the power cord of the adapter to the 48 V connector.

Recalibrating the OSA20

The validity of specifications depends on operating conditions. For example, the calibration validity period can be longer or shorter depending on the intensity of use, environmental conditions and unit maintenance, as well as the specific requirements for your application. All of these elements must be taken into consideration when determining the appropriate calibration interval of this particular EXFO unit.

Under normal use, the recommended interval for your OSA20 is: 1 year.

To ask for a factory recalibration:

Contact the EXFO customer support service (see *Contacting the Technical Support Group* on page 149)

Carrying the OSA20

The two flexible handles located on the top side of the OSA20 allow you to carry it from one location to another, as explained in the following procedure.



CAUTION

Never carry the OSA20 if it has been abruptly turned off (see section *Forcing the OSA20 to Shutdown & Restart* on page 147).

If it has been abruptly turned off, you must turn it on again and turn it off normally as explained in *Turning off the OSA20* on page 27)

To carry the OSA20:

1. Turn the OSA20 off normally (see *Turning off the OSA20* on page 27).
2. Unplug the power cord from the wall socket outlet.
3. Fasten the protective cover on the front panel:
 - 3a. Hold the protective cover with two hands, the hollow side facing the front panel.
 - 3b. Slightly splay the side edges of the protective cover and push it horizontally on the front panel until the two side tabs reach the back of the front frame.
4. Carry the OSA20 with two hands using the two handles on the top side to keep it horizontal.

Recycling and Disposal

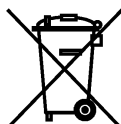

This symbol on the product means that you should recycle or dispose of your product (including electric and electronic accessories) properly, in accordance with local regulations. Do not dispose of it in ordinary garbage receptacles.

For complete recycling/disposal information, visit the EXFO Web site at www.exfo.com/recycle.

11 Troubleshooting

Handling Errors and Warnings

This section lists all the possible error and warning messages, and how to handle them. Errors are classified by functions and the following table enables you to refer to the appropriate section.

Trouble	Error/Warning Code	Possible resolution
System error message	-1000 to -1015	See <i>System Error Messages</i> on page 143
System crash	n/a	See <i>Forcing the OSA20 to Shutdown & Restart</i> on page 147
File handling error message	-2000	See <i>File Handling Error Messages</i> on page 145
	-2001	
User calibration error message	-2002	See <i>User Calibration Error Messages</i> on page 145
	-2003	
	-2004	
	2000	
Trace analysis warning message	2001	See <i>Trace Analysis Warning Messages</i> on page 147
Frozen screen	n/a	See <i>Forcing the OSA20 to Shutdown & Restart</i> on page 147

System Error Messages

Error codes -1000 to -1002, -1004 to -1007, -1010 to -1013, -1015	
Description	System error.
Possible Resolution	<ul style="list-style-type: none"> ➤ Turn the OSA20 off, turn it on again and try to perform the action that caused the error. ➤ If the error appears again, turn the OSA20 off immediately (see <i>Turning off the OSA20</i> on page 27) and contact the EXFO customer support service (see <i>Contacting the Technical Support Group</i> on page 149).

Troubleshooting

Handling Errors and Warnings

Error code -1003	
Description	The system is overheating.
Possible Resolution	<ul style="list-style-type: none">➤ The flow of air cannot circulate freely around the OSA20: Remove all objects that could block the ventilation holes (located at the bottom and right panels of the OSA20) or the cooling fan.➤ The cooling fan grid is dirty: Clean the fan as explained in <i>Cleaning the Fan Grids</i> on page 138.➤ The room temperature is higher than 35 °C (95 °F): Turn the OSA20 off (see <i>Turning off the OSA20</i> on page 27) and make sure the temperature room is lower than 35°C before turning on the OSA20 again.➤ If the previous steps do not solve the problem, turn immediately the OSA20 off (see <i>Turning off the OSA20</i> on page 27) and contact the EXFO customer support service (see <i>Contacting the Technical Support Group</i> on page 149).

Error codes -1008 and -1009	
Description	System error.
Possible Resolution	Turn the OSA20 off (see <i>Turning off the OSA20</i> on page 27) and contact the EXFO customer support service (see <i>Contacting the Technical Support Group</i> on page 149).

Error code -1014	
Description	Fan error.
Possible Resolution	<ul style="list-style-type: none">➤ Turn the OSA20 off and clean the fan as explained in <i>Cleaning the Fan Grids</i> on page 138.➤ If the error appears again, turn the OSA20 off immediately (see <i>Turning off the OSA20</i> on page 27) and contact the EXFO customer support service (see <i>Contacting the Technical Support Group</i> on page 149).

File Handling Error Messages

Error code -2000	
Description	The system cannot save the file.
Possible Resolution	<ul style="list-style-type: none"> ➤ The device on which you are trying to save is full: Free space on the device. ➤ The device is not properly connected to the OSA20: Verify the connection of the device to the USB connector.

Error code -2001	
Description	The system cannot load the file.
Possible Resolution	<ul style="list-style-type: none"> ➤ The file you are trying to load is corrupted or in a format that is not supported: Verify that the file you want to load. ➤ The device from which you are trying to load is corrupted: Verify that the device is working properly.

User Calibration Error Messages

Error code -2002	
Description	The calibration shift is greater than 5 nm since last factory calibration, the system cannot calibrate the OSA20.
Possible Resolution	<ul style="list-style-type: none"> ➤ The optical source is not properly connected to the OSA20: Verify that the patch cord is properly connected to the calibration output connector and to the optical input connector, as explained in <i>Performing a User Calibration</i> on page 140. ➤ Fiber ends or optical connectors are dirty: Clean fiber ends and optical connectors, as described in <i>Cleaning Optical Connectors</i> on page 139. ➤ If optical fibers and connectors are perfectly clean, a factory recalibration may be required, contact the EXFO customer support service (see <i>Contacting the Technical Support Group</i> on page 149).

Troubleshooting

Handling Errors and Warnings

Error code -2003	
Description	The input calibration signal power is too low, the system cannot calibrate the OSA20.
Possible Resolution	<ul style="list-style-type: none">➤ The optical source is not properly connected to the OSA20: Verify that the patch cord is properly connected to the calibration output connector and to the optical input connector, as explained in <i>Performing a User Calibration</i> on page 140.➤ The optical connectors are dirty: Clean the calibration output connector, the optical input connector (as explained in <i>Cleaning Optical Connectors</i> on page 139), and connectors of the patch cord.➤ If the previous steps do not solve the problem, contact the EXFO customer support service (see <i>Contacting the Technical Support Group</i> on page 149).

Error code -2004	
Description	The calibration procedure has exceeded the allowed period of time.
Possible Resolution	<ul style="list-style-type: none">➤ Turn the OSA20 off, turn it on again and try to perform the calibration procedure as explained in <i>Performing a User Calibration</i> on page 140.➤ If the error appears again, turn the OSA20 off immediately (see <i>Turning off the OSA20</i> on page 27) and contact the EXFO customer support service (see <i>Contacting the Technical Support Group</i> on page 149).

Error code -2005	
Description	The input calibration signal not recognized, the system cannot calibrate the OSA20.
Possible Resolution	<ul style="list-style-type: none">➤ The optical source is not properly connected to the OSA20: Verify that the patch cord is properly connected to the calibration output connector and to the optical input connector, as explained in <i>Performing a User Calibration</i> on page 140.➤ If the previous steps do not solve the problem, contact the EXFO customer support service (see <i>Contacting the Technical Support Group</i> on page 149).

Warning code 2000	
Description	The calibration shift since last factory calibration is greater than 1 nm. The power measurement can be less accurate.
Possible Resolution	Contact the EXFO customer support service (see <i>Contacting the Technical Support Group</i> on page 149) to program the recalibration of the OSA20.

Trace Analysis Warning Messages

Warning code 2001	
Description	No result is displayed because too many peaks have been detected.
Possible Resolution	<ul style="list-style-type: none"> ▶ The analysis is restricted to 1000 peaks. If more than 1000 peaks are detected, no result is displayed. Modify the analysis parameters.

Forcing the OSA20 to Shutdown & Restart

In case of system crash and frozen screen, you can abruptly turn the OSA20 off as explained in the following procedure.



CAUTION

- ▶ Do not stop the OSA20 with this procedure if you can turn it off normally as explained in *Turning off the OSA20* on page 27.
- ▶ Never carry the OSA20 if it has been abruptly turned off: see *Carrying the OSA20* on page 142.

To force the OSA20 to shutdown & restart:

1. If the touchscreen is frozen: connect a mouse to one of the USB port and try to shutdown the OSA20 as explained in *Turning off the OSA20* on page 27.

If this does not work, follow the rest of these instructions.

2. Press the On/Off button during 4 seconds.
The system abruptly stops.
3. On the rear panel, set the power switch to **O**.
4. Wait 10 seconds and set the power switch back to **I**.
5. Restart the OSA20 as explained in *Turning on the OSA20 and Accessing the Home Window* on page 26.

Using Remote Assistance Tools

Performing a Self-test

Performing a self-test enables you to detect possible errors on the system, and may be used for remote assistance from the EXFO customer support service.

To perform a self-test:

1. In the OSA20 home window, touch the **System** button.
2. Touch the **More** button to access the system additional information screen.
3. Launch the system self-test by touching the **Self-test** button and wait for its execution.

The result of the test is displayed on screen.

Sending Debug Data to EXFO Support Service

Saving debug data and sending it to the EXFO customer support service can be useful for remote assistance.

To save and send debug data:

1. In the OSA20 home window, touch the **System** button.
If an error occurs at startup and you cannot access the **System** menu, the **Save Debug Data** button is also available in the failed startup window.
2. Touch the **More** button to access the system additional information screen.
3. Connect a USB key on one of the available USB ports on the front panel (see *Front Panel* on page 4).
4. Touch the **Save Debug Data** button.
5. Enter a name for the .zip file and save it on the USB key.
6. Send the saved file to the EXFO customer support service (for contact details, see *Contacting the Technical Support Group* on page 149).

Displaying the User Documentation

You can access the user guide at all times from your unit. Multi-touch screen gestures are available to zoom in or out on the help pages. If a keyboard is connected, you can also use it to zoom in or out and browse the help pages.

The user guide is also available in PDF format on the USB key delivered with the instrument and from the EXFO website:
EXFO.com/en/resources/

To open the user documentation from the GUI:

In the Analysis mode window, click the **Help** tab.

The user guide appears in the main window. Using the **Help** tab during a scan may slow it down.

Contacting the Technical Support Group

To obtain after-sales service or technical support for this product, contact EXFO at one of the following numbers. The Technical Support Group is available to take your calls from Monday to Friday, 8:00 a.m. to 7:00 p.m. (Eastern Time in North America).

Technical Support Group

400 Godin Avenue
Quebec (Quebec) G1M 2K2
CANADA

1 866 683-0155 (USA and Canada)
Tel.: 1 418 683-5498
Fax: 1 418 683-9224
support@exfo.com

For detailed information about technical support, and for a list of other worldwide locations, visit the EXFO Web site at www.exfo.com.

If you have comments or suggestions about this user documentation, you can send them to customer.feedback.manual@exfo.com.

To accelerate the process, please have information such as the name and the serial number (see the product identification label), as well as a description of your problem, close at hand.

Transportation

Maintain a temperature range within specifications when transporting the unit. Transportation damage can occur from improper handling. The following steps are recommended to minimize the possibility of damage:

- Pack the unit in its original packing material when shipping.
- Avoid high humidity or large temperature fluctuations.
- Keep the unit out of direct sunlight.
- Avoid unnecessary shocks and vibrations.

For instructions on returning the OSA20, please contact EXFO (see *Contacting the Technical Support Group* on page 149).

To package the OSA20 for shipment:

If you need to return the OSA20 to EXFO for servicing or factory calibration, use the original packaging.



CAUTION

Before packing the OSA20 in its original packaging:

- **Unplug the cord from the 48 V DC connector and wrap the cord connector to avoid scratching the OSA20 cover.**
- **Unplug the power cord from the AC/DC adapter.**

For instructions on returning the OSA20, please contact EXFO (see *Contacting the Technical Support Group* on page 149).

12 Warranty

General Information

EXFO Inc. (EXFO) warrants this equipment against defects in material and workmanship for a period of 1 year from the date of original shipment. EXFO also warrants that this equipment will meet applicable specifications under normal use.

During the warranty period, EXFO will, at its discretion, repair, replace, or issue credit for any defective product, as well as verify and adjust the product free of charge should the equipment need to be repaired or if the original calibration is erroneous. If the equipment is sent back for verification of calibration during the warranty period and found to meet all published specifications, EXFO will charge standard calibration fees.



IMPORTANT

The warranty can become null and void if:

- unit has been tampered with, repaired, or worked upon by unauthorized individuals or non-EXFO personnel.
- warranty sticker has been removed.
- case screws, other than those specified in this guide, have been removed.
- case has been opened, other than as explained in this guide.
- unit serial number has been altered, erased, or removed.
- unit has been misused, neglected, or damaged by accident.

THIS WARRANTY IS IN LIEU OF ALL OTHER WARRANTIES EXPRESSED, IMPLIED, OR STATUTORY, INCLUDING, BUT NOT LIMITED TO, THE IMPLIED WARRANTIES OF MERCHANTABILITY AND FITNESS FOR A PARTICULAR PURPOSE. IN NO EVENT SHALL EXFO BE LIABLE FOR SPECIAL, INCIDENTAL, OR CONSEQUENTIAL DAMAGES.

Gray Market and Gray Market Products

Gray market is a market where products are traded through distribution channels that are legal but remain unofficial, unauthorized, or unintended by the original manufacturer. Intermediaries using such channels to distribute products are considered to be part of the gray market (hereafter unauthorized intermediary).

EXFO considers that a product originates from the gray market (hereafter gray market product) in the following situations:

A product is sold by an unauthorized intermediary.

A product is designed and destined for a particular market and sold on a second market.

A product is resold, despite being reported lost or stolen.

When products are purchased on the gray market, rather than through an authorized EXFO distribution channel, EXFO is unable to guarantee the source and quality of those products nor the local safety regulations and certifications (CE, UL, etc.).

EXFO will not honor warranty, install, maintain, repair, calibrate, provide technical support nor make any support contracts available for gray market products.

For complete information, refer to EXFO's policy regarding gray market products at www.exfo.com/en/how-to-buy/sales-terms-conditions/gray-market/

Warranty

Liability

Liability

EXFO shall not be liable for damages resulting from the use of the product, nor shall be responsible for any failure in the performance of other items to which the product is connected or the operation of any system of which the product may be a part.

EXFO shall not be liable for damages resulting from improper usage or unauthorized modification of the product, its accompanying accessories and software.

Exclusions

EXFO reserves the right to make changes in the design or construction of any of its products at any time without incurring obligation to make any changes whatsoever on units purchased. Accessories, including but not limited to fuses, pilot lamps, batteries and universal interfaces (EUI) used with EXFO products are not covered by this warranty.

This warranty excludes failure resulting from: improper use or installation, normal wear and tear, accident, abuse, neglect, fire, water, lightning or other acts of nature, causes external to the product or other factors beyond the control of EXFO.



IMPORTANT

In the case of products equipped with optical connectors, EXFO will charge a fee for replacing connectors that were damaged due to misuse or bad cleaning.

Certification

EXFO certifies that this equipment met its published specifications at the time of shipment from the factory.

Service and Repairs

EXFO commits to providing product service and repair for five years following the date of purchase.

To send any equipment for service or repair:

- 1.** Call one of EXFO's authorized service centers (see *EXFO Service Centers Worldwide* on page 154). Support personnel will determine if the equipment requires service, repair, or calibration.
- 2.** If equipment must be returned to EXFO or an authorized service center, support personnel will issue a Return Merchandise Authorization (RMA) number and provide an address for return.
- 3.** If possible, back up your data before sending the unit for repair.
- 4.** Pack the equipment in its original shipping material. Be sure to include a statement or report fully detailing the defect and the conditions under which it was observed.
- 5.** Return the equipment, prepaid, to the address given to you by support personnel. Be sure to write the RMA number on the shipping slip. *EXFO will refuse and return any package that does not bear an RMA number.*

Note: A test setup fee will apply to any returned unit that, after test, is found to meet the applicable specifications.

After repair, the equipment will be returned with a repair report. If the equipment is not under warranty, you will be invoiced for the cost appearing on this report. EXFO will pay return-to-customer shipping costs for equipment under warranty. Shipping insurance is at your expense.

Routine recalibration is not included in any of the warranty plans. Since calibrations/verifications are not covered by the basic or extended warranties, you may elect to purchase FlexCare Calibration/Verification Packages for a definite period of time. Contact an authorized service center (see *EXFO Service Centers Worldwide* on page 154).

Warranty

EXFO Service Centers Worldwide

EXFO Service Centers Worldwide

If your product requires servicing, contact your nearest authorized service center.

EXFO Headquarters Service Center

400 Godin Avenue

Quebec (Quebec) G1M 2K2

CANADA

1 866 683-0155 (USA and Canada)

Tel.: 1 418 683-5498

Fax: 1 418 683-9224

support@exfo.com

EXFO Europe Service Center

Winchester House, School Lane

Chandlers Ford, Hampshire S053 4DG

ENGLAND

Tel.: +44 2380 246800

Fax: +44 2380 246801

support.europe@exfo.com

EXFO Telecom Equipment (Shenzhen) Ltd.

3rd Floor, Building C,

FuNing Hi-Tech Industrial Park, No. 71-3,

Xintian Avenue,

Fuhai, Bao'An District,

Shenzhen, China, 518103

Tel: +86 (755) 2955 3100

Fax: +86 (755) 2955 3101

support.asia@exfo.com

To view EXFO's network of partner-operated Certified Service Centers nearest you, please consult EXFO's corporate website for the complete list of service partners:

<http://www.exfo.com/support/services/instrument-services/exfo-service-centers>.

Chinese Regulation on Restriction of Hazardous Substances (RoHS)

中国关于有害物质限制的规定

NAMES AND CONTENTS OF THE TOXIC OR HAZARDOUS SUBSTANCES OR ELEMENTS CONTAINED IN THIS EXFO PRODUCT

包含在本 EXFO 产品中的有毒有害物质或元素的名称及含量

Part Name 部件名称	Lead 铅 (Pb)	Mercury 汞 (Hg)	Cadmium 镉 (Cd)	Hexavalent Chromium 六价铬 (Cr(VI))	Polybrominated biphenyls 多溴联苯 (PBB)	Polybrominated diphenyl ethers 多溴二苯醚 (PBDE)
Enclosure 外壳	O	O	O	O	O	O
Electronic and electrical sub-assembly 电子和电气组件	X	O	X	O	X	X
Optical sub-assembly ^a 光学组件 ^a	X	O	O	O	O	O
Mechanical sub-assembly ^a 机械组件 ^a	O	O	O	O	O	O

Note:

注:

This table is prepared in accordance with the provisions of SJ/T 11364.

本表依据SJ/T 11364 的规定编制。

O: Indicates that said hazardous substance contained in all of the homogeneous materials for this part is below the limit requirement of GB/T 26572.

O:表示该有害物质在该部件所有均质材料中的含量均在GB/T 26572 标准规定的限量要求以下。

X: indicates that said hazardous substance contained in at least one of the homogeneous materials used for this part is above the limit requirement of GB/T 26572. Due to the limitations in current technologies, parts with the "X" mark cannot eliminate hazardous substances.

X:表示该有害物质至少在该部件的某一均质材料中的含量超出 GB/T 26572 标准规定的限量要求。



标记“X”的部件，皆因全球技术发展水平限制而无法实现有害物质的替代。

a. If applicable.

如果适用。

MARKING REQUIREMENTS

标注要求

Product 产品	Environmental protection uses period (years) 环境保护使用期限 (年)	Logo 标志
This EXFO product 本 EXFO 产品	10	
Battery ^a 电池 ^a	5	

a. If applicable.

如果适用。



www.EXFO.com · info@exfo.com

CORPORATE HEADQUARTERS 400 Godin Avenue

Quebec (Quebec) G1M 2K2 CANADA
Tel.: 1 418 683-0211 · Fax: 1 418 683-2170

TOLL-FREE (USA and Canada)

1 800 663-3936

© 2023 EXFO Inc. All rights reserved.

