

A woman in a black blazer and white pants sits on a blue airport bench, looking at a tablet. A man in a grey suit is in the foreground, looking at a phone. The background is a busy airport terminal.

# Distributed Antenna System TESTING GUIDE

**EXFO**

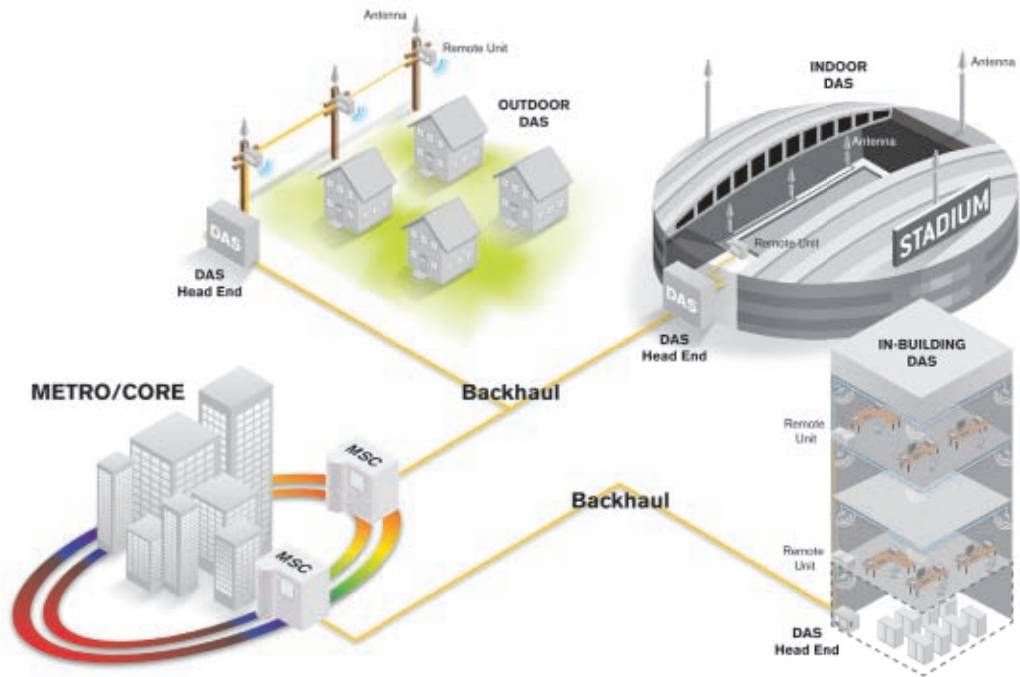

## Table of Contents

1. Wireline Challenges in the Wireless Space.....	2	3. DAS Testing Methods .....	23
1.1 Small Cells .....	3	3.1 Construction.....	24
1.2 RRH .....	4	3.1.1 Connector Maintenance.....	26
1.3 DAS .....	4	3.1.2 Insertion Loss and Optical Return Loss Characterization .....	47
1.4 DAS vs. RRH.....	5	3.1.3 Using a Traditional OTDR:.....	52
1.5 Fiber to the Cell Site .....	8	3.1.4 Using the iOLM:.....	66
		3.1.5 Alternative Methods.....	81
2. Key Physical Parameters That Can Affect DAS Performance.....	11	4. Troubleshooting a Live System.....	85
2.1 Loss Budget .....	12	4.1 Tools That Can Be Used to Troubleshoot a System.....	86
2.2 What Can Affect the Loss Budget? .....	15	4.2 Troubleshooting Process .....	92
2.2.1 Bad Connection .....	19	4.2.1 Fiber Troubleshooting .....	92
2.2.2 Macrobends and Their Effects .....	22	5. Test Documentation .....	97

# 1. Wireline Challenges in the Wireless Space

All across the globe, the landscape of high-rise buildings and municipal water towers is changing. These locations were once barren, but are now home to core macrocellular network installations, specifically cell towers and antennas. Using high-power radio frequency (RF) signals, macrocell sites allow wireless service providers (WSPs) to deliver voice, text and broadband communications over large geographic areas. Unfortunately, as traffic increases, coverage radius decreases. This means that even though cells can be upgraded, coverage cannot be expanded.

Essentially, the best way to feed bandwidth to the entire wireless infrastructure is to increase fiber connectivity and penetration. With that in mind, this paper covers the function and role of antennas, fiber-optic infrastructure requirements, as well as best testing practices.

## **The HetNet Reality**

In the stone age of cellular phones, back when voice communication was the only offering, network design focused on coverage, not capacity. Today's phones have morphed into portable, application-oriented, internet-enabled computers, greatly increasing the strain on network capacity. Unfortunately, adding new macro sites, microcells and picocells simply won't cut it. A better way to augment the macro layer is by adding low-power nodes like femtocells, remote radio heads/units (RRHs/RRUs) and distributed antenna systems (DAS). This enhanced macrocellular network is called a heterogeneous network, or HetNet.

## 1.1 Small Cells

From humble beginnings, small cells are now flourishing.

- › **Femtocell:** A small base station designed for residential use.
- › **Picocell:** A base station that is larger than a femtocell, but smaller than a microcell. These stations can typically handle 10 to 60 simultaneous callers, but in some cases are capable of servicing over 100 callers. Picocells are deployed both indoors and outdoors.
- › **Microcell:** A base station larger than a picocell, but with a smaller coverage area and capacity than a macrocell. These stations are often used to support cellular service in large buildings, conference centers and shopping malls. In high-rise buildings, they feed the DAS to extend coverage to multiple floors.

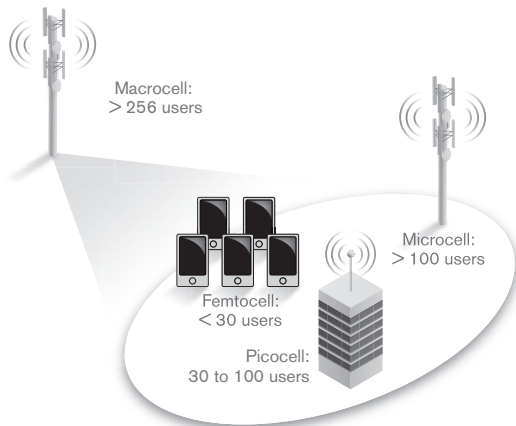

## 1.2 RRH

A remote radio head is a single, outdoor unit with RF front-end functionalities only, and that connects to the baseband processing part of a distributed base station via a point-to-point, bidirectional, analog or digital interconnection link. However, other links are possible, namely star, ring and daisy chain.

Analog links, due to their linearity requirements, require a highly linear system to maintain their spectral emission properties when transporting low-level RF composite signals. Although optical-fiber interconnection cables offer high linearity, they require very expensive optical lasers and drivers.

## 1.3 DAS

Today, DAS is considered a multiple-airlink, multiple-frequency-band and multiple WSP system that is mostly fiber-optics- or coax-based. Designed to distribute cellular signals throughout buildings, active DAS equipment uses head-end and remote units to exploit the expensive part (i.e., the base station) as much as possible.

Since a DAS enables the independent operation of multiple frequency bands and protocols across a single access network, multiple operator network sharing is supported. This capability is the secret to its success in the US market.

## 1.4 DAS vs. RRH

DAS and RRH architectures are similar in a number of ways. They both centralize the baseband processing of the base station at one location, and use strategically located radio modules to satisfy coverage or capacity requirements. Both also use optical fiber to run very high data rates and high-capacity backhaul needs at baseband-unit locations. They both also excel in areas where ultra-high-density nodes are required.

DAS can be considered as an evolution from RRH in the sense that DAS can transport data relevant to multiple RF carriers and multiple WSPs. However, this also means DAS demands a much higher overall link data rate.

On the other hand, RRH can also be considered as an evolution from DAS. While DAS extends the coverage of legacy base stations, RRH offers cost-reducing base-station design. Another major difference is that unlike DAS, which uses RF-optical converters as add-on modules, RRH does not require converters, because it already uses optical technology.

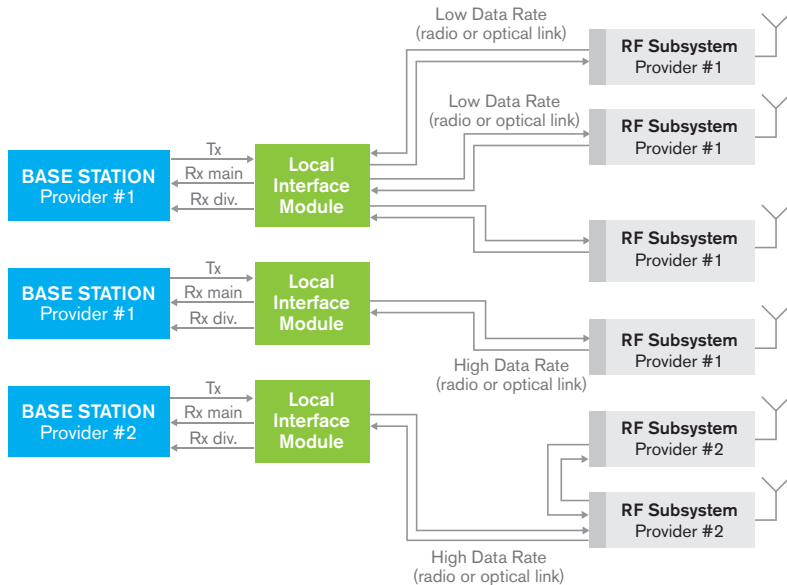

Figure 1 – DAS architecture for three colocated base stations from two different providers and six remotized RF subsystems



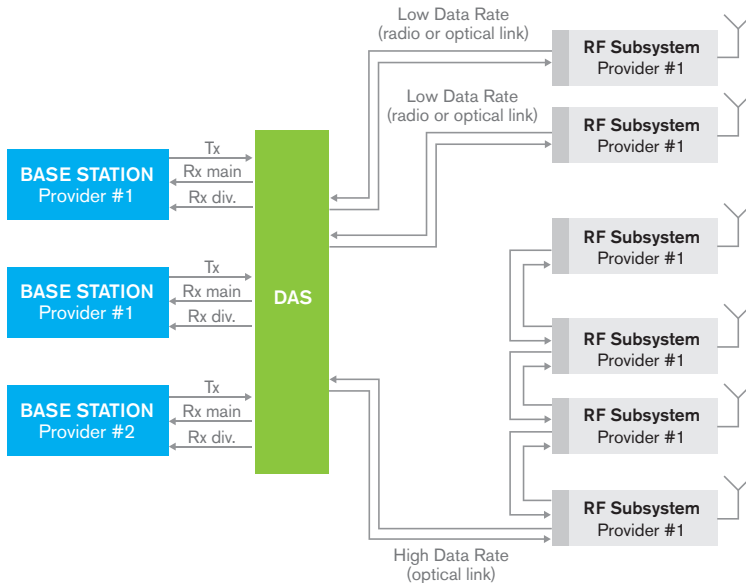

Figure 2 – RRH architecture for three colocated base stations from two different providers and six remotized RF subsystems

## 1.5 Fiber to the Cell Site

By bringing high data rate to the radio/antenna, fiber-optic links deliver the promises made by mobile broadband. Increasing broadband capacity means growing the wireless network, which decreases the cell radius. Therefore, feeding bandwidth to the entire wireless infrastructure means increasing fiber connectivity and penetration. Essentially, more wireless means better and deeper wireline.

Two standards are used to carry traffic over fiber from the base station's radio equipment controller (REC) to the radio equipment: common public radio interference (CPRI) and open base station architecture initiative (OBSAI). CPRI is the predominant standard.

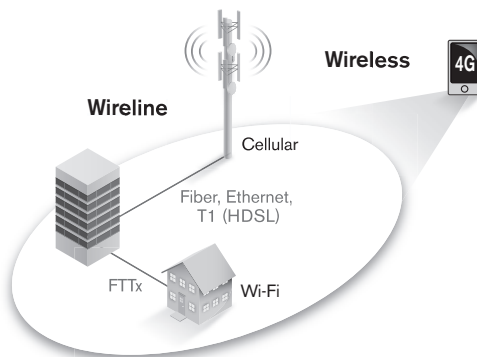

Figure 3 – Out of the air and into the ground at the closest point

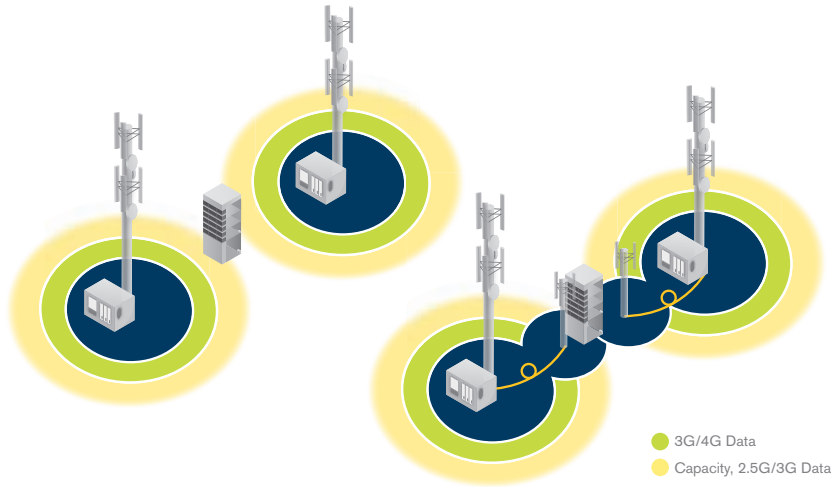

Figure 4 – Fiber-optic systems are the key physical (PHY) transport medium that will unify these new, distributed architectures

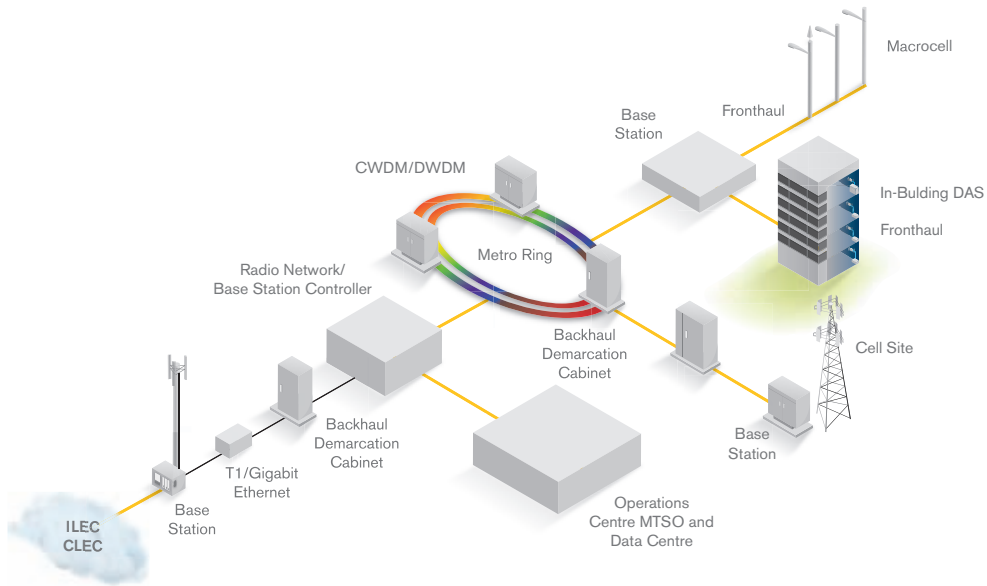

Figure 5 – Fiber unifies the wireless NGN

The purpose of any fiber-optic network is to perform high-speed, error-free data transmission. The best testing practices are required at each phase to achieve the expected data rate and reliability while minimizing costly and time-consuming troubleshooting efforts, including locating dirty/damaged connectors, questionable splices and other faulty components.

In the case of DAS, because a single system can transport data from multiple carriers, the fiber infrastructure has to be installed, qualified, tested and certified by a third party (e.g., antenna or network owner, subcontractor). Moreover, a birth certificate and proof of proper installation is often required.

## 2.0 Key Physical Parameters That Can Affect DAS Performance

As previously stated, the purpose of any fiber-optic network is to perform high-speed, error-free data transmission. Adequate testing during each phase of the network deployment guarantees that products meet specifications, in addition to minimizing costly and time-consuming troubleshooting efforts, including locating dirty/damaged connectors, questionable splices and other faulty components before they disrupt service.

One of the most important factors in ensuring proper transmission is controlling power loss in the network against the link loss-budget specifications from the network design recommendation. This is done by establishing a total end-to-end loss budget with sufficient margin while reducing back reflection to a minimum. This is particularly true for analog RF video signals from extremely narrowband lasers, because strong back reflections degrade the quality of the signal transmission. The following section will take a closer look into those parameters that can greatly affect the performance of the network.

## 2.1 The Loss Budget

One of the first tasks to perform when designing fiber-optic networks is to evaluate the acceptable loss budget in order to create a product that will meet application requirements.

What causes loss in the fiber? The loss includes both intrinsic attenuation and extrinsic discontinuities in a fiber-optic cable, such as connectors and splices. Link loss is wavelength-dependent, measured in decibels per kilometer or dB/km, and used in calculations for determining overall loss budget.

To adequately characterize the loss budget, the following key parameters are generally considered:

- > Transmitter: Launch power, temperature and aging
- > Fiber connections: Connectors and splices
- > Cable: Fiber loss and temperature effects
- > Receiver: Detector sensitivity
- > Others: Safety margin and repairs

When one of the above-listed variables fails to meet specifications, the performance of the network could be greatly affected, or worse, the degradation could lead to network failure.

An example of the typical total loss-budget calculation is illustrated as follows:

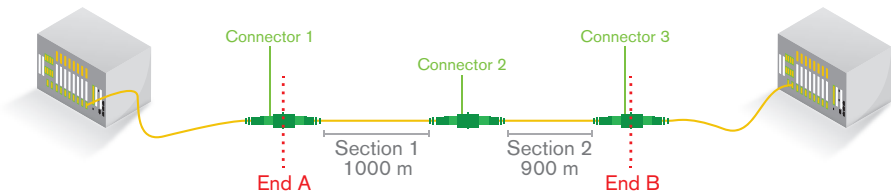

Figure 6 – Typical DAS fiber installation

- > Connector losses, typically around 0.2 dB per connector pair.
- > Fiber loss, which is equal to attenuation multiplied by distance. The maximum distance is limited by the loss budget at the worse-case attenuation wavelength (1310 nm with around 0.33 dB/km attenuation). The maximum length in a DAS application will be a few kilometers in a large deployment.

The loss-budget calculation should be one of the first verifications performed prior to any deployment, and it should be mandatory to verify that the class of system selected is compatible with the topology to be deployed. If, for example, a system is designed with the elements present in Figure 1, and the launch power of the transmitter at 1550 nm is  $-0$  dBm and the detector sensitivity is at  $-10$  dBm, the permitted loss budget of 10 dB will compromise the system performance. However, tighter design tolerances can be set in order to prevent long-term evolution of the network. For example, the typical budget loss in DAS will be between 1.5 and 5 dB.

If we take the network topology shown in Figure 6, the total loss can be calculated as shown below:

	Typical Loss (dB)	Number/Length	Total Loss (dB)
Connector (APC)	~ 0.2	3	0.6
Fiber sections (fiber type G.652C)			
1310 nm	~ 0.35/km	1.9 km	0.7
1550 nm	~ 0.20/km		0.4
Total loss budget			
1310 nm			1.3
1550 nm			1

Table 1 — Loss-budget calculation sample

Therefore, the total loss measured during network deployment should not exceed the total loss budget allowed by the system design, and should also have enough margin to compensate for any loss fluctuation that could occur during the lifecycle of the system.



## 2.2 What Can Affect the Loss Budget?

As we saw in the previous section, the optical distribution fiber is comprised of several elements that respectively contribute to the overall loss in a system. In theory, taking the theoretical insertion loss (e.g., fiber attenuation) of each element into consideration should be sufficient to ensure that the loss budget will be respected once the elements are deployed. Unfortunately, this is not the case, and the following sections will highlight a few phenomena that could eventually affect the insertion loss (IL) or optical return loss (ORL) of these elements when the time comes to deploy them in the field.

As previously mentioned, the phenomena that will create exaggerated IL or ORL can be intrinsic or extrinsic to the fiber. The figure below illustrates a few examples of these elements.

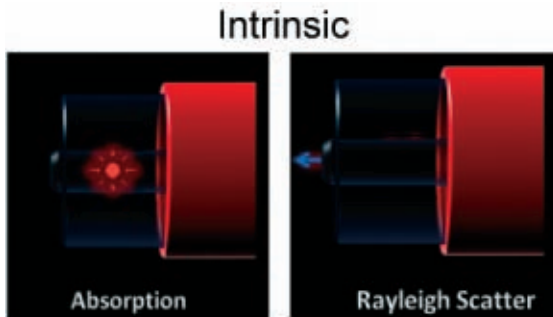

## Extrinsic

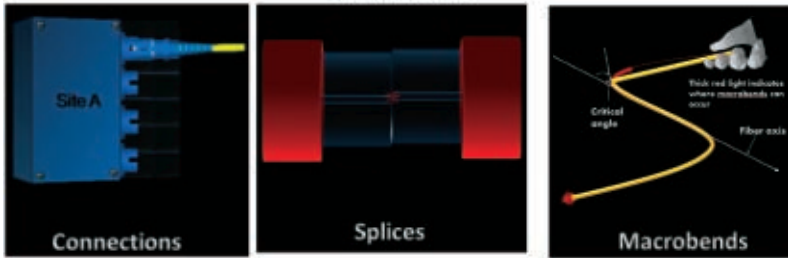

Figure 7 – Phenomena affecting the overall loss budget

**Insertion loss** is the increase in attenuation caused by inserting a connector pair (or passive component) into a fiber-optic link. A certain number of signals will be lost at each point.

**Optical return loss** is the ratio of the forward optical power to the reflected optical power. When light is injected into a fiber-optic component, such as a connector, multiplexer or the fiber itself, some of the energy is transmitted, some is absorbed and some is reflected. The total light that comes back (i.e., is reflected) is what we refer to as ORL.

ORL is caused by two fundamental effects. The first is the Rayleigh scattering effect, which is specifically the part that goes back to the source point, known as backscattering. The second effect consists of Fresnel reflections (Figure 8), which are small portions of light that are reflected back when light travels through materials of differing indexes of reflection.

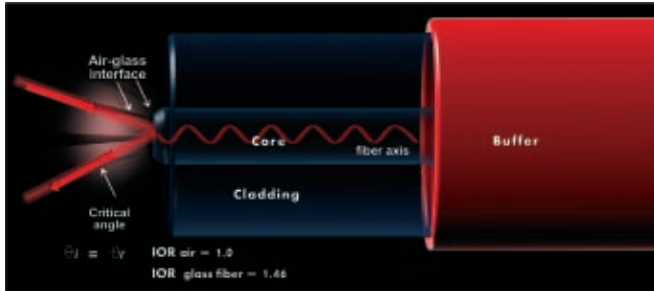

Figure 8 – Fresnel reflection

Rayleigh backscattering consists of reflections that result from light scattering due to impurities in the fiber, and is intrinsic to the fiber itself; the light interacts with the density fluctuations of the fiber. The phenomenon can be caused by a variation in the material density and composition, which gives rise to variations in the fiber's refractive index. This causes part of the wave to escape from the waveguide. When the size of the defect is less than one tenth of the wavelength's incident light, it is referred to as scattering, whereas backscattering refers to the part that is captured in the fiber, and which propagates in the backward direction.

As shown in Figure 9, the overall ORL will be the cumulative effect of the Rayleigh backscattering and the Fresnel reflection.

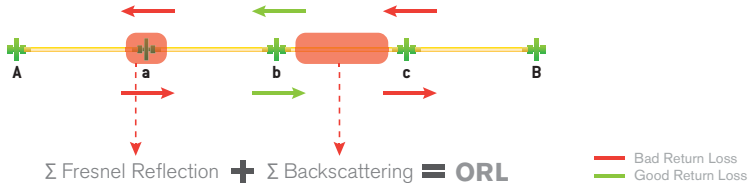

Figure 9 – ORL

As shown in Figure 10 below, the higher the value, the better overall for the performances of the system.

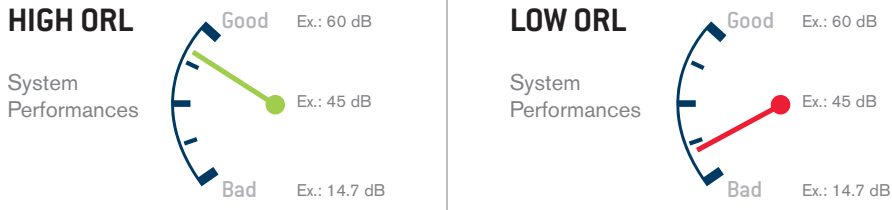

Figure 10 – System performances vs. ORL

## 2.2.1 Bad Connection

In order for the system to work properly, network elements must be interconnected. Currently, there are two main methods being used to interconnect all the network elements:

- > Connector
- > Splice (fusion or mechanical)

### **Connector**

Connectors are key components that interconnect the entire set of network elements, which is why it is essential to maintain them. Keeping them in good condition will ensure that all equipment operates at maximum performance, thus avoiding catastrophic network failure.

Because singlemode fibers have very small cores, typically 9 to 10  $\mu\text{m}$  in diameter, a single particle of dust or smoke could block a substantial transmission area and increase the loss.

Damaged or dirty connectors can lead to:

- > Erroneous test results
- > Poor transmission (high IL or ORL)
- > Permanent damage to the link in the case of high-power transmission

Various causes can lead to a bad connection involving the connector:

- > Contamination on a connector's endface (soil, dust, isopropyl alcohol, oil from hands, mineral oils, index-matching gel, epoxy resin, oil-based black ink and gypsum).
- > Angled polished connectors (APC) connected to ultra-polished connectors (UPC).
- > Physical damage to the connector's endface.

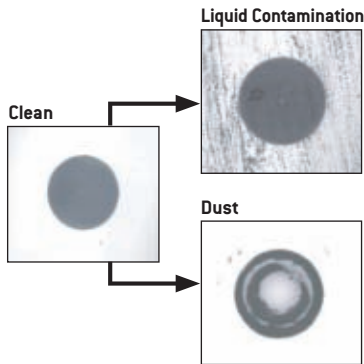

Figure 11 – Example of soiled connector endfaces

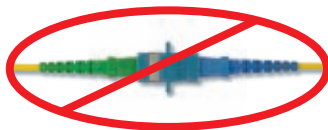

Figure 12 – UPC connector jointed to APC connector



Figure 13 – Chipped connector

## Splice

Poor fiber alignments (i.e., the cores are not totally aligned) are the main cause of coupling loss when two fibers are spliced together. Another great source of coupling loss results from differences in optical properties between the connected fibers. If the spliced fibers have different optical properties, such as different core or cladding diameters, the coupling losses may increase. This is what we called core mismatch.

- > Core misalignment–Exaggerated loss
- > Core mismatch–Gainer

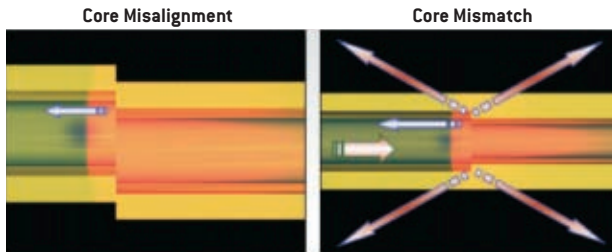

Figure 14 – Possible issues of spliced fibers

For more details on splice characterization, please refer to the material on the optical time-domain reflectometer (OTDR) and intelligent Optical Link Mapper (iOLM) in the construction sections.

## Effects of a Bad Connection

A bad connection will generally increase the insertion loss of a device/element (e.g., a splitter) in the optical distribution network (ODN), which will in turn contribute to the overall budget loss. If there are too many bad connections in the ODN, or if there is one with exaggerated loss, the overall budget may not be respected, which could result in a non-functional network that does not perform the expected services.

Another effect that can result from a bad connection (e.g., a UPC connector connected to an APC) is the increase of the overall optical return loss (ORL). In the past, this parameter was not taken into key testing consideration. With analog signals, ORL measurement is highly recommended in order to obtain ghost-free transmission when analog video is introduced. In general, high ORL may have the following effects on the network:

- › Strong fluctuations in laser output power
- › Potential permanent damage to the transmitter
- › Higher bit error rate (BER) in digital systems
- › Distortions in analog signals

### 2.2.2 Macrobends and Their Effects

As its name suggests, a macrobend consists of a curvature in an optical fiber; the curvature's radius is a few centimeters. Macrobends locally decrease mode confinement, causing radiation loss. In addition, it is widely recognized that the induced attenuation increases with wavelength due to a wider modal distribution and more power in the cladding.

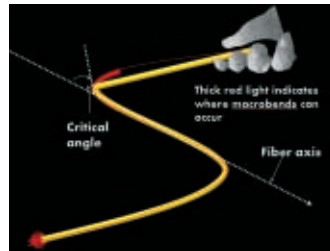

Figure 15 – Macrobend



Most of the time, macrobends are found in fiber organizers and at or near patch panels, and result from cable mishandling or mechanical stresses in the environment. In many optical fiber communications systems, macrobends will occasionally boost link loss to a point where it exceeds the system's loss budget. Since the wholesale replacement of transmitters and receivers is not cost-effective, it becomes the responsibility of local maintenance crews to locate and repair these macrobends.

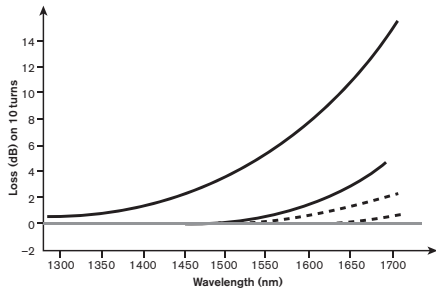

Figure 16 – Ten wraps on a mandrel produce this type of curve for several types of optical fiber

### 3.0 DAS Testing Methods

Once the design of the system has been completed, the lifecycle of a network generally consists of three main phases.

The following sections highlight some the key testing elements that should be considered during the lifecycle of an optical physical layer of a distributed system antenna (DAS).

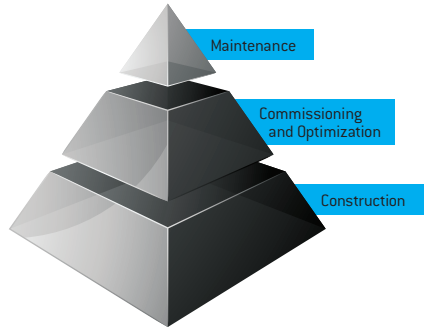

Figure 17 – DAS testing pyramid

## 3.1 Construction

The bottom of the pyramid in Figure 17 indicates the most commonly seen DAS deployment stage: construction. This stage consists of most of the work required to prepare the dwelling connected fiber up to the fiber expansion units. In some cases, the installation contractor will be responsible within this demarcation.

Installation of the optical physical layer during the construction stage is one the most important steps towards an easy-to-maintain system and a high return on investment. Sufficient testing during construction will locate problematic splices, dirty or damaged connectors and other faulty components before they can cause service disruption, thus minimizing costly and time-consuming troubleshooting efforts during the commission phase. It is therefore mandatory to implement best optical-testing practices during this phase in order to ensure a successful, yet easy-to-maintain, DAS in the future.

Proper connector care and fiber-optic cable handling are an important piece of the puzzle, and ensure a less problem-prone network. Another important aspect is the end-to-end fiber documentation. These documents are critical to ensuring a shorter period of time in responding to customer complaints or service interruptions owing to network-related issues.

Testing during the construction phase is a key step:

- › To qualify each fiber section of the system and document it for future reference
- › To ensure it meets transmission-system requirements (standards)
- › To avoid delays and costly repairs when the system is turned up

	Test Type	Why Test?	Test Parameters	Test Gear	Testing Considerations
Construction	> Out-of-service test	<ul style="list-style-type: none"> <li>&gt; To qualify each optical element (e.g., fiber, connector) of the system</li> <li>&gt; To ensure the installation meets transmission system requirements</li> <li>&gt; To avoid delays and costly repairs when turning up the system</li> <li>&gt; To future-proof the network</li> </ul>	<ul style="list-style-type: none"> <li>&gt; Connectors and ferrules cleanliness</li> <li>&gt; Optical loss (OL) or IL of each element</li> <li>&gt; Total end-to-end loss compared to optical loss budget</li> <li>&gt; Fiber mapping</li> <li>&gt; ORL measurement, especially for RF/analogue video</li> </ul>	<ul style="list-style-type: none"> <li>&gt; OTDR or iOLM</li> <li>&gt; Video inspection probe</li> <li>&gt; Cleaning kit</li> </ul>	<ul style="list-style-type: none"> <li>&gt; Connector inspection</li> <li>&gt; Testing at different wavelengths (1310 and 1550 nm) for IL and ORL</li> <li>&gt; LinkView or OTDR trace documentation using 1310/1550 (reporting)</li> <li>&gt; Data storage</li> <li>&gt; Testing total link or segments</li> <li>&gt; Labour involved</li> </ul>

Table 2 — Summary table for DAS testing phases

### 3.1.1 Connector Maintenance

As we have seen in the previous section, connectors are key elements that interconnect different components of a network; failing to inspect and clean them as needed can lead to network failures.

#### What areas do we need to inspect and clean?

The following areas should be kept clean at all times:

- > Patch panels (e.g., splitter cabinets)
- > Test jumpers
- > Cable connectors



Figure 18 – Patch panel inspection

#### When and how often should the connectors be inspected and cleaned?

The very first step in the fiber testing process consists of inspecting the connectors at every testing phase, i.e., construction, activation and maintenance. Connectors should only be cleaned if they are found to be dirty after completion of the inspection.

#### What should we look for when inspecting a connector?

During inspection of a connector ferrule, the following two types of problems may be encountered: a damaged endface or a dirty endface.

Physical damage to the connector endface is, in general, permanent, and will, in most cases, require a connector replacement—unless the damage is superficial. In order to determine whether or not the damage is superficial, a good rule of thumb is to discard or replace any connector that has scratches near or across the fiber core (see Figure 19 a), since these scratches can generate high loss and affect the connector performance. For physical damage such as chipped cladding (see Figure 19 b), worn connectors and/or excessive epoxy residue on the cladding, the connector must be replaced.

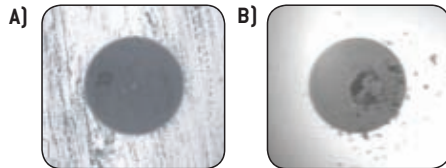

Figure 19 – a) Scratch in the core region  
b) Chipping on the cladding

In an ideal world free of contaminants, connector endfaces would always be clean and would not require in-depth maintenance. Unfortunately, this is not the case. In fact, there are many fiber-optic connector contaminants. For example, a 1  $\mu\text{m}$  dust particle on a singlemode core can block up to 1% (0.05 dB loss) of light. As such, imagine what a 9  $\mu\text{m}$  dust particle could do. Another important reason to keep endfaces free of contaminants is the effect of high-power components on the connector endface; some of today's telecommunication components can produce signals with a power level up to +30 dBm (1 W). This can lead to catastrophic results if they are used with a dirty or damaged connector endface (e.g., fiber fuse).

Dust, isopropyl alcohol, oil from hands, mineral oils, index matching gel, epoxy resin, oil-based black ink and gypsum are among the contaminants that can affect a connector endface. Some of these contaminants consist of single soil particles, while others may consist of complex soil combinations. Note that each contaminant has a different appearance, but regardless of appearance, the most critical areas for inspection are the core and cladding regions, because contamination in these regions can greatly affect the quality of the signal. Figure 20 illustrates the endfaces of different connectors as examined by a video inspection probe.

A good practice for avoiding connector endface damage or contamination is to always keep a protective cap on the unused connector. In addition, we would like stressing the importance of storing unused protective caps in a sealed container to prevent contamination. When inserting the protective cap on a ferrule, refrain from inserting it all the way to prevent small dirt particles from accumulating at the bottom of the cap. If the bottom of a contaminated cap comes into contact with the connector endface, it could contaminate the connector endface. Note that outgassing from the manufacturing process of the dust cap can leave a residue of the mold release agent or materials in the cap. Therefore, the presence of a dust cap does not guarantee cleanliness; it is a protective device used to prevent damage. Please also take note that test jumpers and connectors delivered in sealed bags from the supplier are not always clean prior to sealing, and may therefore require cleaning. Fortunately, soiled connectors can be cleaned effectively using proper cleaning tools and appropriate cleaning procedures.

**NOTE:** The inspection should also be performed on new, factory-delivered jumpers and cables to ensure cleanliness.

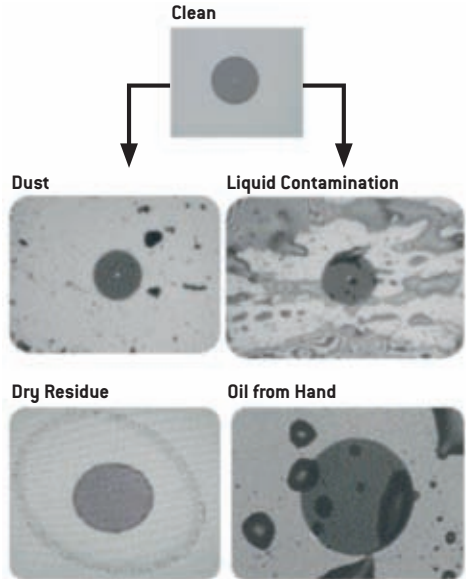

Figure 20 – Clean connector endface vs. different contaminant types

## Most Common Connector Issues:

### ***Dust/dirt residue***

If connectors are not cleaned properly, residues will be transferred, which can lead to permanent damage during mating.

### Before Mating

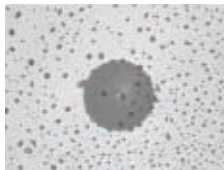

### After Mating

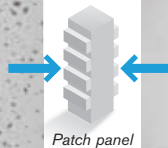
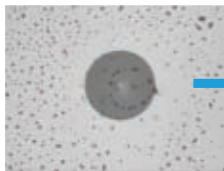

Patch panel

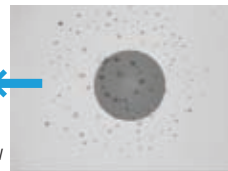

### ***Wet residue***

Most often caused by an incorrect cleaning technique; fibers must be carefully dried after a wet cleaning.

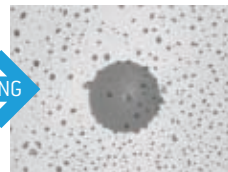
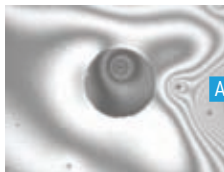

## ***Oily residue***

Most often caused by contact with fingers—technicians must not touch the fiber ends.

- › An oily residue may act as a matching gel
- › It may not affect IL and RL in the short term
- › It may trap dust and increase IL and RL over time

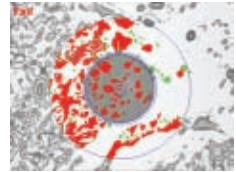
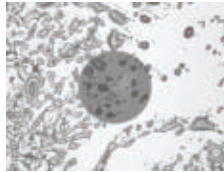

## ***Circular residue***

Most often caused by an incorrect cleaning technique

- › Occurs when fiber is mated while still wet
- › Typically happens in the contact area
- › Contamination will migrate from male to female fiber ends

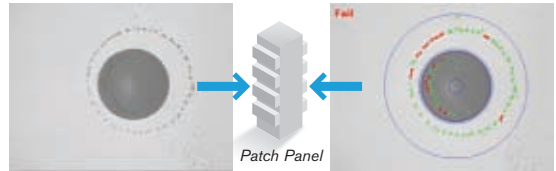



### **Adhesive region defects**

- > May occur during the manufacturing process or from mishandling
- > Epoxy residue and chips may occur in this region
- > Normal if size does not exceed standards

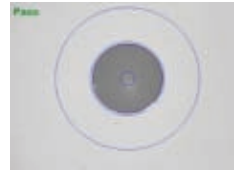
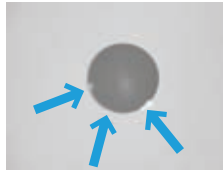

### **Dirty/damaged connector**

Most often results from poor handling or cleaning

- > Defects appear small, but may still fail inspection criteria

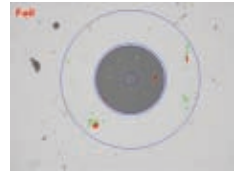
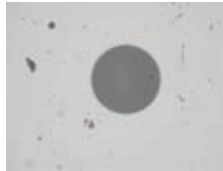

### **Scratches**

- > May appear as light or dark defects
- > May be hard to see with the naked eye
- > Critical when in the core area of SM fibers



## How do you inspect the connectors?

The core and cladding are the two main sections of the fiber, and it is therefore critical that they be kept in good condition in order to minimize the loss that occurs when two connector ferrules are mated together. To carry out connector maintenance properly, the connector endface must be visually inspected right from the outset. Because the core diameter of a singlemode fiber is less than 10 microns, it is impossible to tell whether the ferrule is clean without the proper inspection tool. For this reason, having the right tools is essential.

To properly inspect the connector endface, use of a microscope specially designed for the fiber-optic connector endface is recommended. There are many types of inspection tools on the market, but they all fall into two main categories: fiber inspection probes (also called video fiberscopes) and optical microscopes. For security purpose, this document recommends use of a fiber inspection probe. Table 3 below lists the main characteristics of this tool.

Inspection Tool	Main Characteristics
<b>Video fiber inspection probes</b>	<ul style="list-style-type: none"><li>&gt; Image display on an external video screen, PC or a test instrument (see Figure 3)</li><li>&gt; Eye protection from direct contact with a live signal</li><li>&gt; Image-capture capability for report documentation</li><li>&gt; Ease-of-use in crowded patch panels</li><li>&gt; Ideal for inspecting patch cords, patch panels and multifiber connectors (e.g., MTP)</li><li>&gt; Different degrees of magnification available (100x, 200x, 400x)</li><li>&gt; Adapter tips for all connector types available</li></ul>

Table 3 — The main characteristics of video fiber inspection probes

To remove subjectivity and ensure a common level of acceptance between suppliers and installers, use of a high-magnification fiber inspection probe such as the FIP-400 and automated analysis software such as ConnectorMax is highly recommended.

When using ConnectorMax, the proper analysis standard must be used. FTTH networks will typically require use of SC/UPC or SC/APC connectors.

One of the following analysis standards must be selected within the software for proper analysis:



Connector Type	Analysis Standard
<b>SC/UPC male or female</b>	IEC-61300-3-35 singlemode single-fiber UPC connector with ORL $\geq 45$ dB
	
<b>SC/APC male or female</b>	IEC-61300-3-35 singlemode single-fiber APC connector
	

Table 4 — IEC analysis standards

## Step-by-Step Inspection Instructions

1. Connect the probe to the connector to be inspected, and then select the corresponding IEC standard (see Table 4).
2. Adjust the magnification.
3. Start the analysis using the Capture button.
4. Connect, clean or replace the connectors according to the analysis result.
5. Save the analysis report.

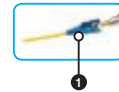

If the user does not have access to ConnectorMax software, a manual inspection must be performed. The user will have to refer to the analysis criteria and make a manual assessment as to whether or not the connector is good. It is important to understand that this technique can lead to false assumptions. To be on the safe side and ensure proper network operation, the user must be very rigorous and not tolerate defects in the core and cladding area, but this could lead to unnecessary rejects.

The flow chart below demonstrates the inspection procedure recommended by the IEC-61300-3-35 standard:

**NOTE:** It is highly recommended to perform at least one cleaning attempt before rejecting any connector. Following this recommendation may help reduce unnecessary connector rejects.

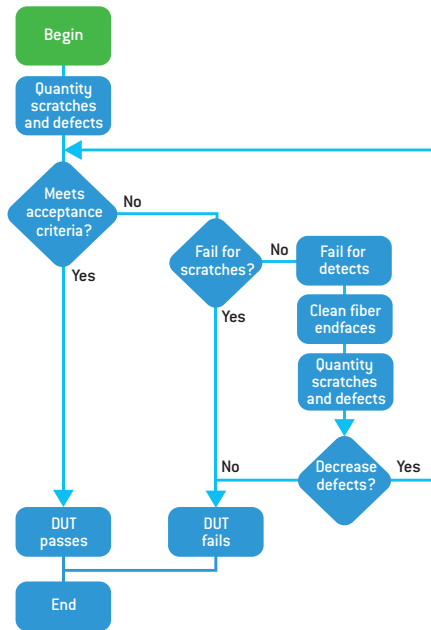

Figure 20 – Inspection procedure flowchart

## Recommendations when making connections

- › When testing in a patch panel, only the port corresponding to the fiber under test should be uncapped; protective caps should be replaced immediately after testing.
- › Unused caps should be kept in a small plastic bag.
- › The life expectancy of a connector is typically rated at 500 mating cycles.
- › The test jumpers used in conjunction with the test instruments should be replaced after a maximum of 500 mating cycles (refer to EIA-455-21A).
- › If a launch cord is used for OTDR testing, do not use a test jumper in between the OTDR and launch cord, or in between the launch cord and the patch panel. Launch cords should be replaced or sent back to manufacturers for repolishing after 500 mating cycles.
- › Unmated connectors should never be allowed to touch any surface, and a connector ferrule should never be touched for any reason other than cleaning.
- › Each connector should be cleaned and inspected after cleaning or prior to mating using a fiberscope or, better yet, a videoscope.
- › Test equipment connectors should also be inspected (preferably with a videoscope) and cleaned (if necessary) every time the instrument is used.

## Tools Needed for Inspection: Fiber Inspection Probe





















Image	Description	Part Number
	<p>FIP-400 handheld stand-alone kit. This basic solution supports manual inspection only.</p> <p>No analysis or data storage capability.</p>	<p>FIP-400-SINGLE-D or FIP-400-DUAL-D</p>
	<p>FIP-400 Fiber Inspection Probe used on EXFO's FOT-930 OLTS or AXS-110 OTDR.</p> <p>This basic solution supports manual inspection only.</p> <p>No analysis or data storage capability.</p>	<p>FP4S or FP4D option</p>
	<p>FIP-400 Fiber Inspection Probe used on EXFO's portable platforms such as the FTB-1 or FTB-200.</p> <p>Provides automated analysis, data storage and report generation in the field on the same unit as the OTDR.</p>	<p>FP4S or FP4D option and FPSA ConnectorMax</p>
	<p>FIP-400 Fiber Inspection Probe used on a PC or laptop.</p> <p>Provides automated analysis, data storage and report generation.</p>	<p>IFIP-400-USB2-SINGLE or FIP-400-USB2-DUAL and FPSA-PC ConnectorMax</p>

Table 5 — Fiber inspection probe configurations

The fiber inspection probe comes with different tips to match the different connector types found in DAS deployment, including angle-polished connectors (APC) and flat-polished connectors (PC, SPC or UPC).

FIP-400 Adapter Tips APC					FIP-400 Adapter Tips UPC	
Male	Female				Male	Female
 FIP-400-U25MA	 FIP-400-SC-APC	 SC Simplex (singlemode/ multimode)	 SC Duplex (singlemode/ multimode)	 FC Simplex (singlemode/ multimode)	 FIP-400-U25M	 FIP-400-FC-SC
	 FIP-400-FC-APC	 ST Simplex (singlemode/ multimode)	 E2000 Simplex (singlemode/ multimode)	 FIP-400-ST		
	N/A	 E2000 Duplex (singlemode/ multimode)	 FIP-400-E2000			
	 FIP-400-E2000-APC	 E2000 Duplex (singlemode/ multimode)	 FIP-400-E2000			



















FIP-400 Adapter Tips APC					FIP-400 Adapter Tips UPC		
Male	Female				Male	Female	
	 FIP-400-LX5-APC		LX-5 Simplex (singlemode/ multimode)		 FIP-400-U12M	 FIP-400-LX.5	
			LX-5 Duplex (singlemode/ multimode)				
			LC Simplex (singlemode/ multimode)				
			LC Duplex (singlemode/ multimode)				
		N/A		MU Simplex (singlemode/ multimode)			
				MU Duplex (singlemode/ multimode)			 FIP-400-MU

Table 6 — Common inspection tips

For more information about connector inspection tips, please refer to our inspection poster on EXFO.com.

## Tools Needed for Cleaning

A proper cleaning method and appropriate accessories must always be used with connectors that fail acceptance criteria for endface inspection. Failure to use proper cleaning accessories and techniques may result in connector damage and/or network failures.

### ***Dry-cleaning***

Dry cleaning using a mechanical cleaner is the recommended first step. If, after two dry cleaning attempts, there is still soil present on the connector, proceed to hybrid cleaning.



*Single-fiber mechanical cleaner  
(male/female)*



*Multifiber mechanical cleaner (MTP/IMPO)  
(male/female)*



*Patch-cord mechanical cleaner  
(female only)*

## How to dry-clean

Insert the jumper, and then push the outer shell to begin cleaning. A clicking sound will indicate that cleaning is complete. Some mechanical cleaners are compatible with male and female jumpers, as well as with multifiber push-on (MPO) and other connectors.



### How to clean a single fiber connector with a dry-cleaning method

Scan and watch the video

([www.exfo.com/en/EXFO-Store/EXFO-Apps/How-to-videos/Optical-Connector-2](http://www.exfo.com/en/EXFO-Store/EXFO-Apps/How-to-videos/Optical-Connector-2))



Advantages	Disadvantages
<ul style="list-style-type: none"><li>&gt; Convenience of readily available tools</li><li>&gt; Fast and easy</li></ul>	<ul style="list-style-type: none"><li>&gt; Could possibly create electrostatic charges</li><li>&gt; Not effective in removing all contaminant types</li><li>&gt; Potential cost consideration</li></ul>

Table 7 — Advantages and disadvantages of using the dry-cleaning method

## Hybrid cleaning

Hybrid cleaning combines the wet and dry cleaning methods, and involves use of a solvent. The first step is to clean the connector endface with solvent, and then dry off any remaining residue using either a wipe or swab. If, after using the hybrid cleaning method, the connector still fails to meet the acceptance criteria, you should consider replacing the connector.



**Cleaning pen**

*Used to dispense optical grade solvent to clean optical connectors*



**Cleaning swabs**

*Used to clean the inside of female connectors and adaptors*



**Lint-free wipes**

*Used in dry cleaning procedures and also used to dry out any solvent*

## How to clean using the hybrid method

1. Wet a corner of the wipe with solvent.
2. In a smooth linear motion, trace the endface of the jumper over the wet area two times.
3. In a smooth linear motion, trace the endface of the jumper over the dry area three times.





## How to clean a single fiber connector with a hybrid cleaning method

Scan and watch the video

([www.exfo.com/en/EXFO-Store/EXFO-Apps/How-to-videos/Optical-Connector-3](http://www.exfo.com/en/EXFO-Store/EXFO-Apps/How-to-videos/Optical-Connector-3))



Advantages	Disadvantages
<ul style="list-style-type: none"><li>&gt; Cleans all soil types</li><li>&gt; Reduces the potential of static in field soil accumulation</li><li>&gt; Automatically dries moisture and solvent used in the cleaning process</li><li>&gt; Captures soil in the wiping material as an integrated aspect of the cleaning procedure</li><li>&gt; Not expensive</li></ul>	<ul style="list-style-type: none"><li>&gt; Requires multiple products and retraining in existing procedures</li></ul>

Table 8 — Advantages and disadvantages of using the hybrid cleaning method

## Cleaning and Inspection Kits

The recommended all-in-one inspection and cleaning kit is the CLEANING-KIT-DELUXE-SINGLE or the CLEANING-KIT-DELUXE-DUAL, which include:

1. FIP-400 Fiber Inspection Probe and display:
2. FIP-400-D: Handheld Display with a 3.5 in. TFT screen
3. FIP-400-P Video Inspection Probe
4. FIPT-400-FC-SC tip for bulkheads
5. FIPT-400-LC LC tip for bulkhead adapters
6. FIPT-400-U25M
7. FIPT-400-U12M
8. Electro-Wash® MX cleaning pen
9. QbE™ Dry Fiber Optic Wipes
10. Mechanical cleaner for 1.25 mm connectors
11. Mechanical cleaner for 2.5 mm connectors
12. CLETOP® Ferrule Cleaning Cassette,  
Blue Tape Reel (Type B ), green
13. Watertight transit protector case



Advanced Fiber Inspection Probe test kits: The TK-1-FIP-400 includes:

**Basic:**

1. TK-1-FIP-400: FTB-1 Intelligent Fiber Inspection and Certification Test Set
2. FIP-400-P Video Inspection Probe
3. FIPT-400-FC-SC tip for bulkheads
4. FIPT-400-U25M
5. Electro-Wash® MX cleaning pen
6. QbE™ Dry Fiber Optic Wipes
7. 1.25 mm and 2.5 mm cleaning swabs
8. FTB-1 Utility Glove
9. ConnectorMax (optional)
10. Power meter (optional)

**Deluxe:**

1. TK-1-FIP-400: FTB-1 Intelligent Fiber Inspection and Certification Test Set
2. FIP-400-P Video Inspection Probe
3. FIPT-400-FC-SC for bulkheads
4. FIPT-400-U25M
5. (1) Electro-Wash® MX cleaning pen
6. (1) QbE™ Dry Fiber Optic Wipes
7. (1) IBC™ Brand Cleaner for 2.5 mm connectors
8. (1) IBC™ Brand Cleaner for 1.25 mm connectors
9. FTB-1 Utility Glove
10. ConnectorMax (optional)
11. Power meter (optional)



Product Name and Complementary Products			Use For	Main Characteristics	Compare To	Advantages	Disadvantages
Solution No.	Main Production Solution	Complementary Products					
1	FIP-400-D-SINGLE or FIP-400-D-DUAL	None	Connector inspection	<ul style="list-style-type: none"> <li>&gt; Basic solution allowing manual inspection</li> <li>&gt; Includes a video inspection probe and a handheld field display</li> </ul>	2	<ul style="list-style-type: none"> <li>&gt; Easy to carry in the field</li> <li>&gt; Inspection solution at an affordable entry-level price</li> </ul>	<ul style="list-style-type: none"> <li>&gt; No automated analysis</li> <li>&gt; No data storage capability</li> <li>&gt; Requires technician with a good understanding of connector maintenance</li> </ul>
2	FIP-400-USB2-DUAL-FPSA or FIP-400-USB2-SINGLE-FPSA	Requires extra PC	Connector inspection with automated analysis	<ul style="list-style-type: none"> <li>&gt; Complete solution allowing inspection with automated diagnostics (ConnectorMax software)</li> </ul>	1	<ul style="list-style-type: none"> <li>&gt; Eliminates guesswork</li> <li>&gt; Ensures consistent acceptance criteria (based on IEC/IPC) throughout the company</li> <li>&gt; Help eliminate unnecessary truck rolls</li> <li>&gt; Allows for work documentation (data saving)</li> </ul>	<ul style="list-style-type: none"> <li>&gt; Requires an extra PC (or laptop for field application)</li> <li>&gt; Can be hard to operate in some field applications</li> </ul>
3	FP4S-FPSA or FP4D-FPSA	Portable Platform: FTB-1 or FTB-200 or FTB-500	Connector inspection with automated analysis	<ul style="list-style-type: none"> <li>&gt; Complete solution allowing inspection with automated diagnostics (ConnectorMax software), in a field-adapted platform</li> </ul>	1	<ul style="list-style-type: none"> <li>&gt; Eliminates guesswork</li> <li>&gt; Ensures consistent acceptance criteria (based on IEC/IPC) throughout the company</li> <li>&gt; Help eliminate unnecessary truck rolls</li> <li>&gt; Allows for work documentation (data saving)</li> <li>&gt; Can be combined with other testing needs (e.g., OTDR) for an all-in-one solution</li> </ul>	<ul style="list-style-type: none"> <li>&gt; More expensive</li> </ul>
					2	<ul style="list-style-type: none"> <li>&gt; Platforms are easier to carry in the field compared to ordinary laptops.</li> <li>&gt; Can be combined with other testing needs (e.g., OTDR) for an all-in-one solution</li> </ul>	

Table 9 — Summary of recommendations: Test gear for successful connector maintenance



### 3.1.2 Insertion Loss and Optical Return Loss Characterization

Once the connector of the fiber under test has been inspected, the next step is to characterize the loss and fiber attenuation to ensure that the fiber meets supplier or design specifications.

There are several ways to characterize the fiber during construction, and several testing methods can be used to measure key parameters such as IL and ORL.

This document explains how to perform characterization using reflectometry-based methods during the construction phase. For reasons that will be explained in the upcoming sections, we recommend using one of the following measurement tools:

- > A traditional OTDR
- > An iOLM

*Figure 21 – Truck diagram of DAS with its main components*



An OTDR identifies and specifically locates individual events in a fiber-optic span, which typically consists of sections of fiber joined by connectors and splices. An OTDR test is a single-ended test performed by one technician. An OTDR transmits pulsed light signals along a fiber span in which light scattering occurs due to discontinuities such as connectors, splices, bends and faults. The OTDR then detects and analyzes the parts of the signals that are returned by Fresnel reflections and Rayleigh backscattering. Fresnel reflections are small portions of light that are reflected back when light travels through materials of differing indexes of reflection. Rayleigh backscattering consists of reflections resulting from light scattering due to impurities in the fiber. Additional details on OTDR theory can be found in our Application Note 194 on EXFO.com.

The very accurate, yet time-consuming and complex OTDR test procedure can now be performed automatically with an intelligent iOLM. This solution employs different pulse widths to fully characterize each section of a network with the optimal pulse. The iOLM then consolidates all of this information into a single, comprehensive link view; the operator does not have to manually compare results at different pulses. The iOLM provides the loss and ORL of the link, in addition to identifying all the network elements, such as splices, splitters and connectors, and offering the loss and reflectance of the identified elements. And, when a specific element or the link itself gets a “fail” verdict, the iOLM provides a diagnosis to help the operator resolve the problem. The whole routine takes about 30 to 60 seconds, depending on network complexity.

Characteristics	OTDR	iOLM
Number of technicians required	1	1
Technical expertise needed to perform the test	Medium to high	Low
Number of acquisitions required to characterize network	An average of three depending on link complexity; each acquisition is estimated at an average of 45 s/wavelength	1 (average of 45 seconds; multiple acquisitions are done automatically by the iOLM)
Average test time per fiber	Typically 6 to 15 minutes, depending on link complexity and technician's skills	≈ 45 seconds to 1 minute
Physical mapping of the link	Yes	Yes
Graphical representation of the link	Traditionally graphical representation	Link view with icons
Provides insertion loss	Yes	Yes
Provides optical return loss	Yes	Yes
Provides length of the fiber	Yes	Yes
Live-fiber testing port	Yes	Yes
In-line power meter	Yes	Yes
Automatic diagnostics	Macrobend detection and pass/fail status	Yes, global and individual pass/fail status plus diagnosis information for each failure
Troubleshooting	Yes	Yes
Live testing	Yes	Yes
Offers easy transpose fiber detection	No	No

Table 10 — Main differences between traditional OTDR and iOLM

A testing method based on reflectometry will provide the IL/ORL characterization desired during the construction phase, and will also allow for detection and positioning of the following issues, if present on the link:

- > Fiber misalignment
- > Fiber mismatch
- > High-loss or reflective connectors
- > High-loss splitter branches
- > Fiber breaks
- > Macrobends

### Unidirectional vs. Bidirectional Testing:

Bidirectional testing is specifically recommended when there are splices present on the fiber. When splicing different types of fiber and testing with a reflectometry-based method (OTDR or iOLM), a significant loss or gain (depending on the test direction) could appear due to the difference in the fiber's mode-field diameters. A good example of this would be splicing G.652D fiber with G.657 fiber. In such a case, the only way to get the real loss value of the splice is to test from both directions, and to average the loss values of both directions.

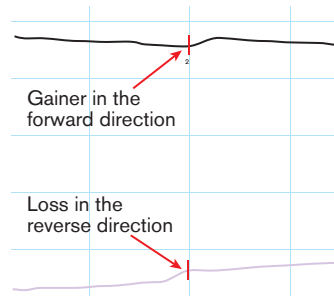

Figure 22 – OTDR Gainer

## System Characterization

Figure 23 below shows a simplified view of the system, with only one uplink (UL) and downlink (DL) fiber that will be used to feed the RF signal to an antenna.

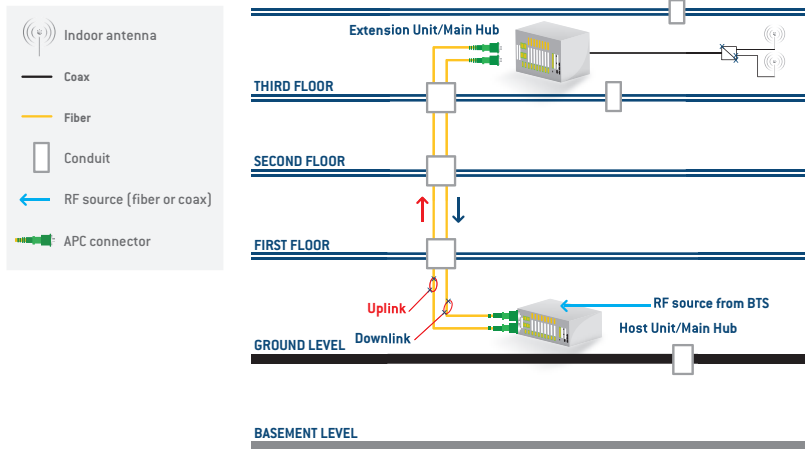

Figure 23 – Fiber section of DAS

The two scenarios described in the next section highlight the main difference between using a traditional OTDR versus advanced technologies such as an iOLM.

### 3.1.3 Using a Traditional OTDR

#### One Technician: Unidirectional Characterization of Uplink and Downlink

For this scenario, we will assume that the OTDR test will be performed from end A. The recommended equipment needed to conduct this characterization with one technician is as follows:

- > 1x FIP-400 with cleaning kit
- > 1x FTB-1 with ConnectorMax software and an OTDR module
- > 3x SPSB with the appropriate connector interface

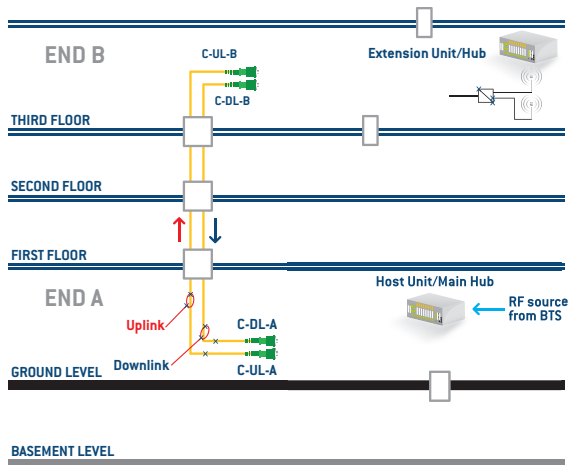
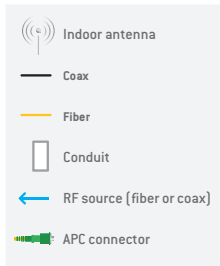

Characterization Parameters	Uplink Fiber		Downlink Fiber	
	END A	END B	END A	END B
Connector	Yes	Yes	Yes	Yes
IL	From A to B		From A to B	
ORL	View from A		From A to B	

Table 11 — Characterization parameters provided with unidirectional testing

## END B → STEP 1

The first step the technician should perform at end B is to inspect the connector (as demonstrated in section 3.1.1 Connector Maintenance) of the fiber to be tested. In the example below, the technician will inspect both connector C-UL-B and connector C-DL-B, and save the results once both connectors meet the acceptance criteria. The results should be saved with the right documentation (e.g., the correct Cable ID and Fiber ID).

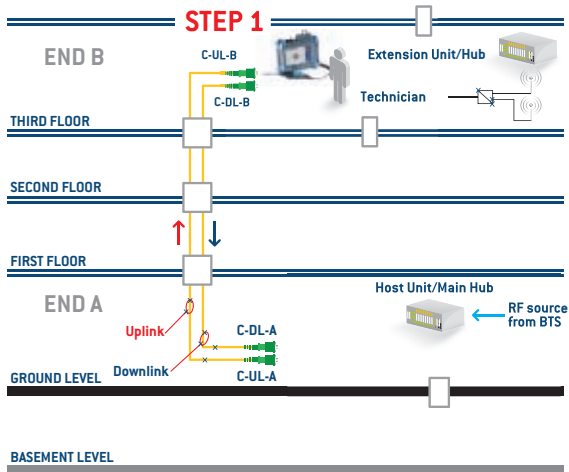
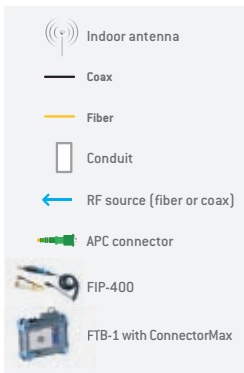

Figure 25 – One technician: End B connector inspection



## END B → STEP 2

Once the connector has been inspected, as shown in Figure 26, the technician will connect a receive fiber on the C-UL-B and C-DL-B connector, and then go to end A. Note that while the technician could work with only one receive fiber, this would greatly increase the back and forth between end A and end B.

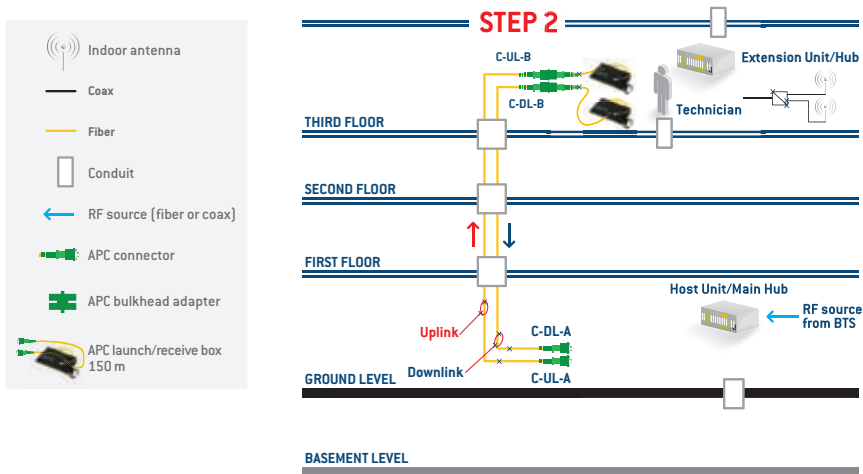

Figure 26 – One technician: Receive-box installation at end B

## END A → STEP 3

The first step at end A will be to inspect connector C-UL-A and C-DL-A, and to save the results when both connectors meet the acceptance criteria. Results should be saved with the right documentation (e.g., the correct Cable ID and Fiber ID).

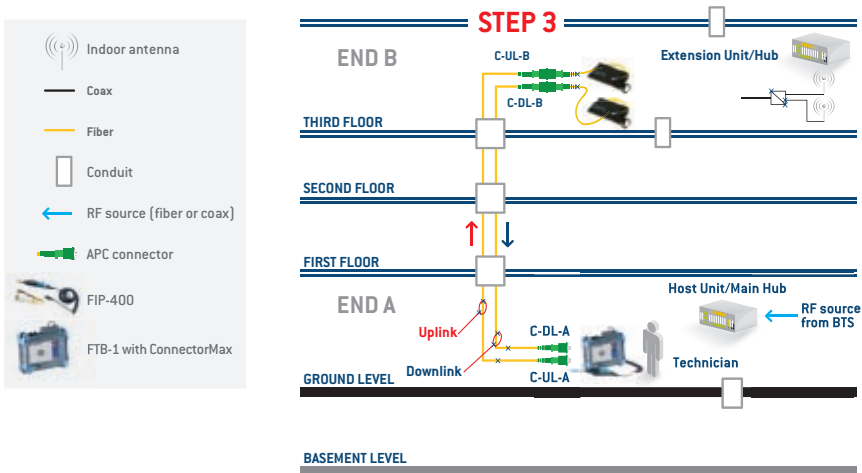

Figure 27 – One technician: End A connector inspection

## END A → STEP 4 and 5

For step 4, once the connector has been inspected and meets acceptance criteria, the technician will proceed by connecting one end of the launch box to connector C-UL-A, and then connect the other end to the OTDR port.

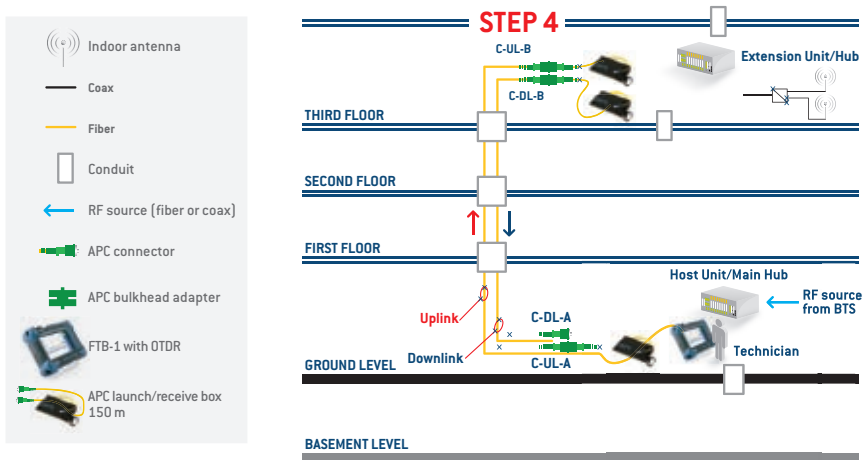

Figure 28 – One technician: Unidirectional uplink characterization

Once the FTB-1 is connected, the technician should select the desired testing mode (Auto or Advanced), enter the test-parameter wavelengths, distance range and pulse width, and then start the acquisition. Once the acquisition is completed, results should be saved with the right documentation (e.g., the correct Cable ID and Fiber ID).

To complete testing on this fiber pair, disconnect the launch box from connector C-UL-A of the UL fiber, and then connect it to connector C-DL-A of the DL fiber. Once the launch box is connected, the technician should select the desired testing mode (Auto or Advanced), enter the test-parameter wavelengths, distance range and pulse width, and then start the acquisition. Once the acquisition is completed, results should be saved with the right documentation (e.g., the correct Cable ID and Fiber ID).

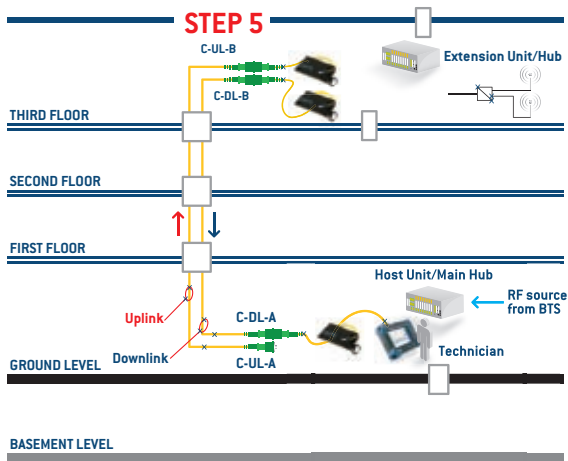
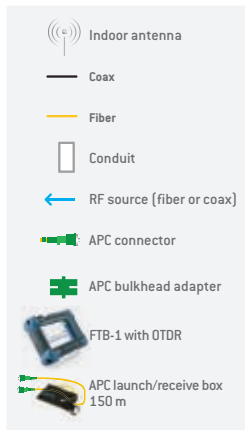

Figure 29 – One technician: Unidirectional downlink characterization

As mentioned in the previous section, when testing with standard OTDRs, the technician may have to perform a few acquisitions using different pulse width and averaging times in order to fully characterize the link under test.

## Bidirectional Characterization of the Uplink and Downlink

This scenario can be accomplished by one technician equipped with the following:

- > 1x FIP-400 with cleaning kit
- > 1x FTB-1 with ConnectorMax software and an OTDR module
- > 4x SPSB with the appropriate connector interface

Characterization Parameters	Uplink Fiber		Downlink Fiber	
	END A	END B	END A	END B
Connector	Yes	Yes	Yes	Yes
IL	From A to B From B to A		From A to B From B to A	
ORL	View from A View from B		View from A View from B	

Table 12 — Characterization parameters provided with unidirectional testing

### STEPS 1 to 5

Steps 1 to 5 are identical to the previous test scenarios, with the addition of the two following steps:

- 6- Once the tests are completed at end A, the technician must install the received box at end A.
- 7- Go to end B to perform OTDR testing from end B to end A on both the UL and DL fiber. The technician should then perform the actions described in steps 4 and 5 of the previous example in order to conduct the test in the opposite direction.

## Two Technicians: Unidirectional Characterization of Uplink and Downlink

The characterization parameters provided with unidirectional testing are the same as those outlined in Table 12; however, the overall time needed to complete a given job will be shorter, because the two technicians will not have to change locations.

For this scenario, we will assume that the OTDR test is being performed from end A.

The recommended equipment for conducting this characterization with two technicians is as follows:

Technician 1 (located at end A)

- > 1x FIP-400 with cleaning kit
- > 1x FTB-1 with ConnectorMax software and an OTDR module
- > 1x SPSB with the appropriate connector interface

Technician 2 (located at end B)

- > 1x FIP-400 with cleaning kit
- > 1x FTB-1 with ConnectorMax software
- > 1x SPSB with the appropriate connector interface

## STEP 1 – Connector inspection

Both technicians should inspect all of the connectors (as demonstrate in section 3.1.1 Connector Maintenance) of the fibers being tested. In our example, the technicians will simultaneously inspect connectors C-UP-A, C-DL-A, D-UP-B and D-DL-B. The results should be saved with the right documentation (e.g., the correct Cable ID and Fiber ID).

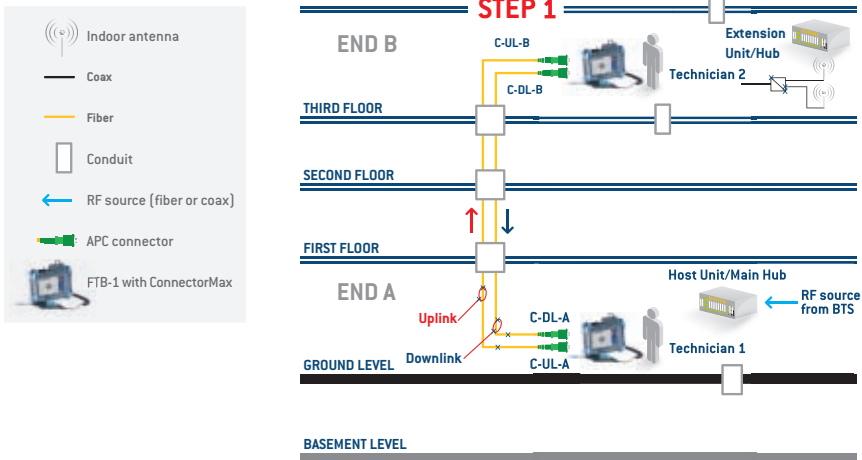

Figure 30 – Two technicians: End A and B connector inspection

## STEP 2 – Installation of the launch/receive box and the UL fiber test

Once the connector has been inspected and meets the acceptance criteria, technician 2 will connect the launch box to the UL fiber, and technician 1 will connect one end of the launch box to connector C-UL-A, and connect the other end to the OTDR port. Once the FTB-1 is connected, technician 1 should select the desired testing mode (Auto or Advanced), enter the test parameters, such as test wavelengths and distance range, and then start the acquisition. Once the acquisition is completed, the results should be saved with the right documentation (e.g., the correct Cable ID and Fiber ID).

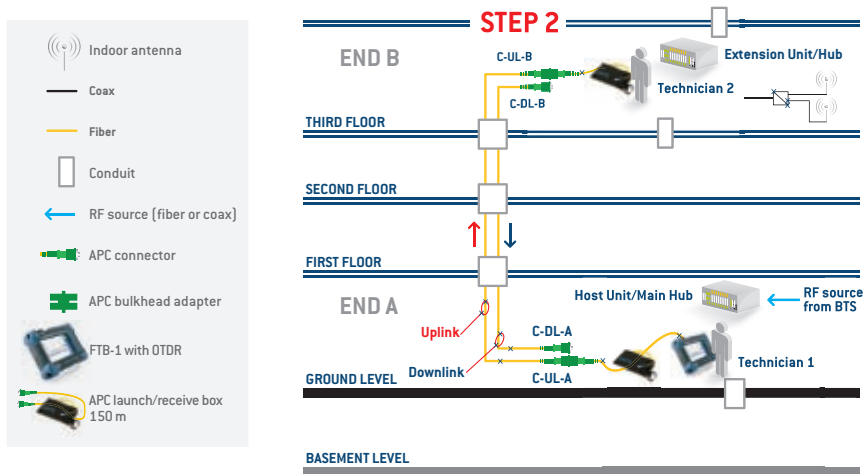

Figure 31 – Two technicians: Preparation for unidirectional UL fiber testing



### STEP 3 – Installation of the launch/receive box and DL fiber test

**NOTE:** Because all of the connectors were previously inspected in STEP 1, the technicians should not need to re-inspect the connector. If there are doubts as to whether there could be any connector contamination, the technicians should re-inspect the connector to ensure it still meet the acceptance criteria. Both technicians should follow the procedure described in step 2, but this time apply it to the DL fiber (as shown in Figure 31).

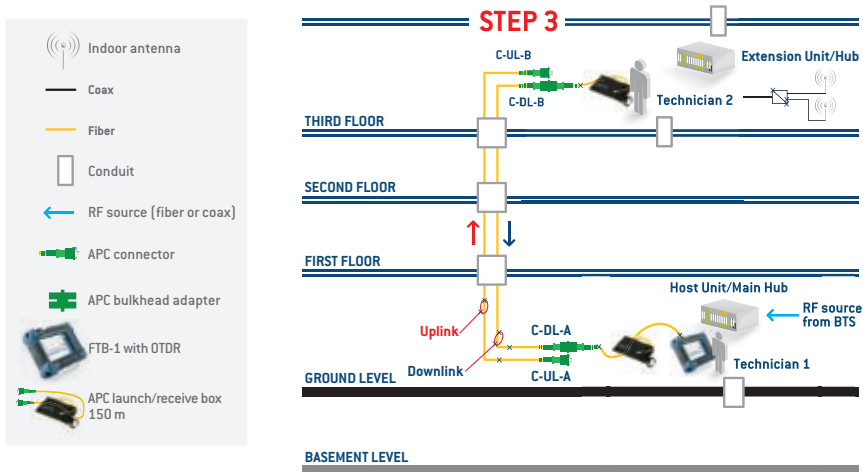

Figure 32 – Two technicians: Preparation for DL fiber testing

## **Bidirectional Characterization of Uplink and Downlink**

The characterization parameters provided with bidirectional testing will be the same as those specified in Table 12, but the overall time needed to complete a given job will be shorter, because the two technicians will not have to change locations.

Technician 1 (located at end A)

- > 1x FIP-400 with cleaning kit
- > 1x FTB-1 with ConnectorMax software and an OTDR module
- > 2x SPSB with the appropriate connector interface

Technician 2 (located at end B)

- > 1x FIP-400 with cleaning kit
- > 1x FTB-1 with ConnectorMax software
- > 2x SPSB with the appropriate connector interface

### ***STEP 1 – Connector inspection***

Steps 1 is identical to the step 1 outlined in the previous test scenarios.

## STEP 2 – Installation of the launch/receive box and the UL fiber test

Both technicians will connect the launch/receive box onto the fiber being tested. In this example, we will start with the UP fiber. Technician 1 will start the test from end A to end B, and then save the results with the right documentation (e.g., the correct Cable ID and Fiber ID). To facilitate post-processing, we recommend that you save this result by indicating AB in the file name, or that you use AB as a tag in the the OTDR setup.

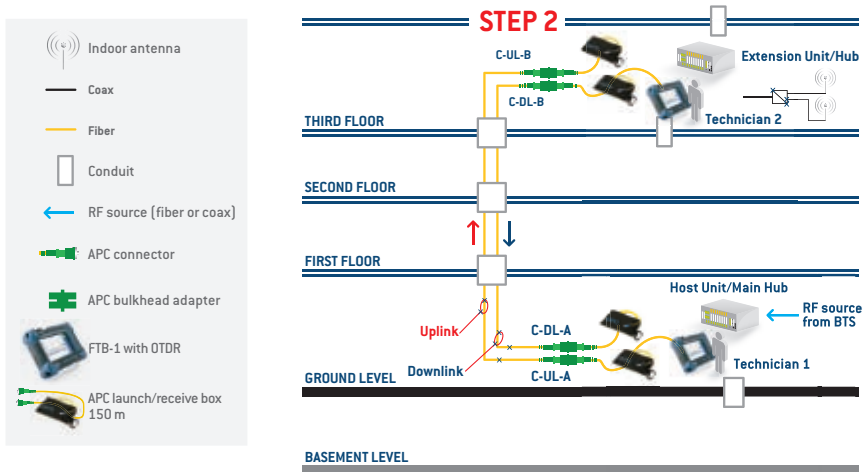

Figure 33 – Two technicians: Preparation for bidirectional UL fiber testing

While technician 1 is completing the test, the second technician can initiate the test on the other fiber, saving the result using the same documentation as technician 1. To facilitate post-processing, we recommend that you save this result by indicating BA in the file name, or that you use BA as a tag in the OTDR setup.

**NOTE:** For optimal results if bidirectional analysis is to be conducted in post-processing, it is important for both technicians to use the same test parameters.

### ***STEP 3 – Installation of the launch/receive box and the DL fiber test***

To test the opposite direction of the uplink and downlink fiber, the technician should follow the same procedure specified in step 2. Once this has been completed, both technicians can move on to the next pair of uplink and downlink fibers.

#### 3.1.4 Using the iOLM

##### **One Technician: Unidirectional Characterization of the Uplink and Downlink**

For this scenario, we will assume that the iOLM test will be performed from end A. The recommended equipment needed to conduct this characterization with one technician is as follows:

- > 1x FIP-400 with cleaning kit
- > 1x FTB-1 with ConnectorMax software and an iOLM module
- > 3x SPSB with the appropriate connector interface

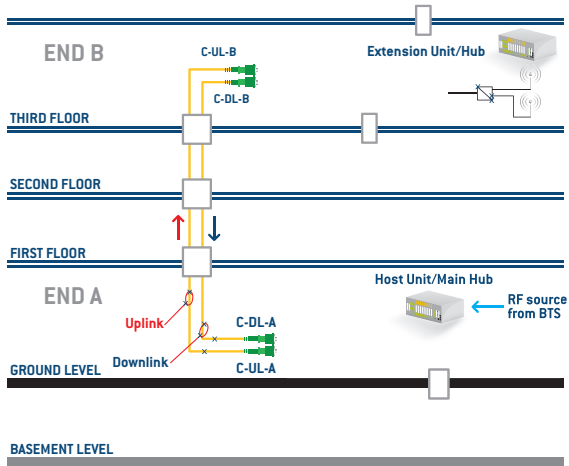
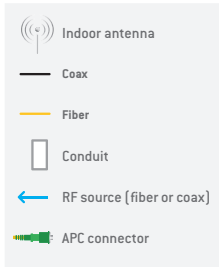

Characterization Parameters	Uplink Fiber		Downlink Fiber	
	END A	END B	END A	END B
Connector	Yes	Yes	Yes	Yes
IL	From A to B		From A to B	
ORL	View from A		View from A	

Table 13 — Characterization parameters provided with unidirectional testing

## END B → STEP 1

The first step the technician should perform at end B is to inspect the connector (as demonstrated in section 3.1.1 Connector maintenance) of the fiber to be tested. In the example below, the technician will inspect both the C-UL-B and C-DL-B connectors, and save the results once both connectors meet the acceptance criteria. The results should be saved with the right documentation (e.g., the correct Cable ID and Fiber ID).

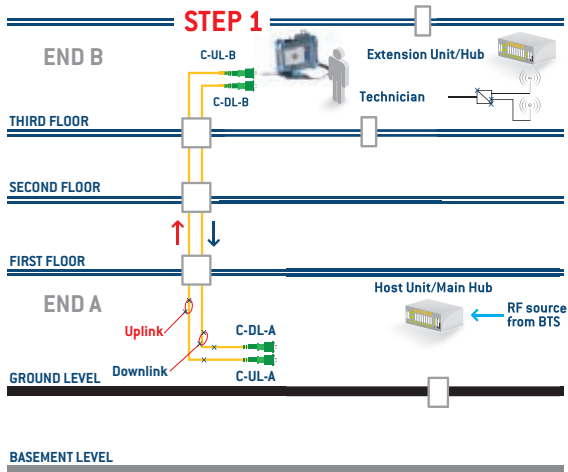
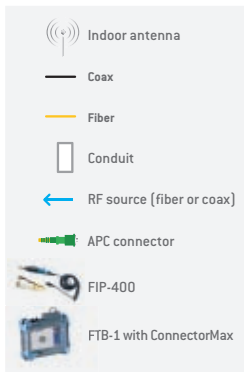

Figure 34 – One technician: End B connector inspection

## END B → STEP 2

Once the connectors have been inspected, as shown in Figure 34, the technician will respectively connect a receive fiber on C-UL-B and C-DL-B connector and go to the end A.

**NOTE:** The technician could work with only one receive fiber but this would greatly increase the number of back and forward between end A and end B.

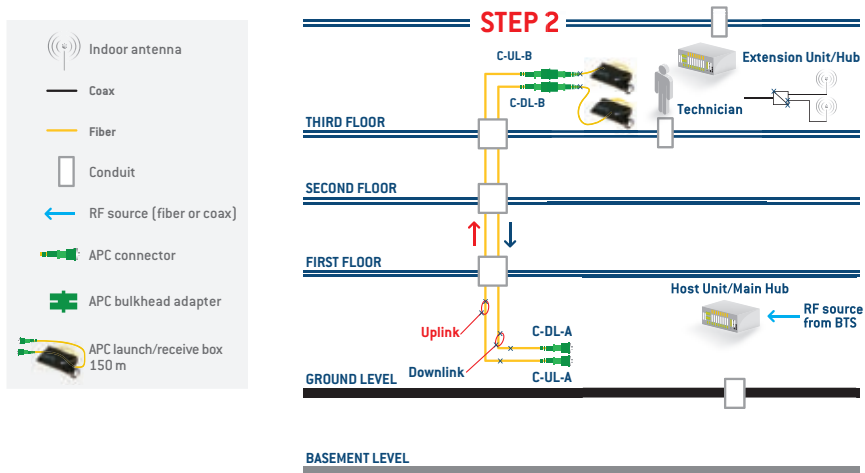

Figure 35 – One technician: Receive-box installation at end B



## END A → STEP 3

The first step at end A will be to inspect connectors C-UL-A and C-DL-A, and to save the results once both connectors meet the acceptance criteria. The results should be saved with the right documentation (e.g., the correct Cable ID and Fiber ID).

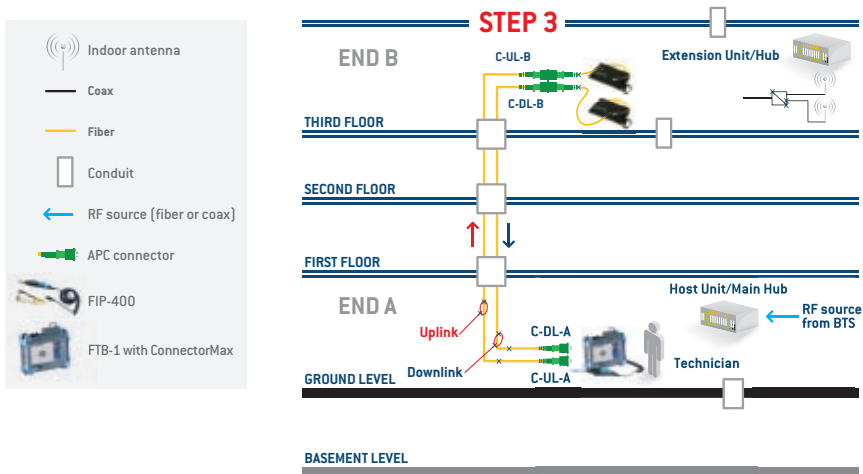

Figure 36 – One technician: End A connector inspection

## END A → STEP 4 and 5

Once the connector has been inspected and meets the acceptance criteria, the technician will connect one end of the launch box to connector C-UL-A, and connect the other end to the iOLM port (as shown in Figure 37).

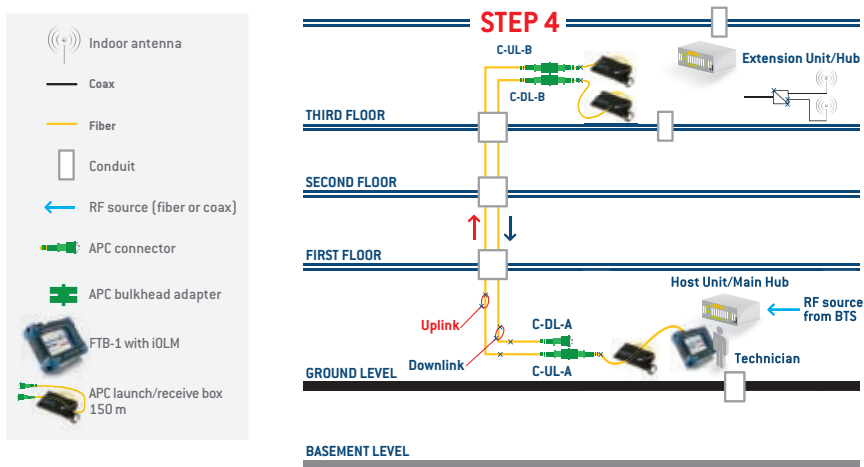

Figure 37 – One technician: Unidirectional uplink characterization

The iOLM controls every parameter, and uses different pulse widths to fully characterize the link. Once the acquisition is completed, results should be saved with the right documentation (e.g., the correct Cable ID and Fiber ID).

To complete testing on this fiber pair, disconnect the launch box from connector C-UL-A of the UL fiber, and then connect it to connector C-DL-A of the DL fiber (as shown in Figure 38). Once the launch box is connected, the technician simply presses start to launch the acquisition. Once the acquisition is completed, the results should be saved with the right documentation (e.g., the correct Cable ID and Fiber ID).

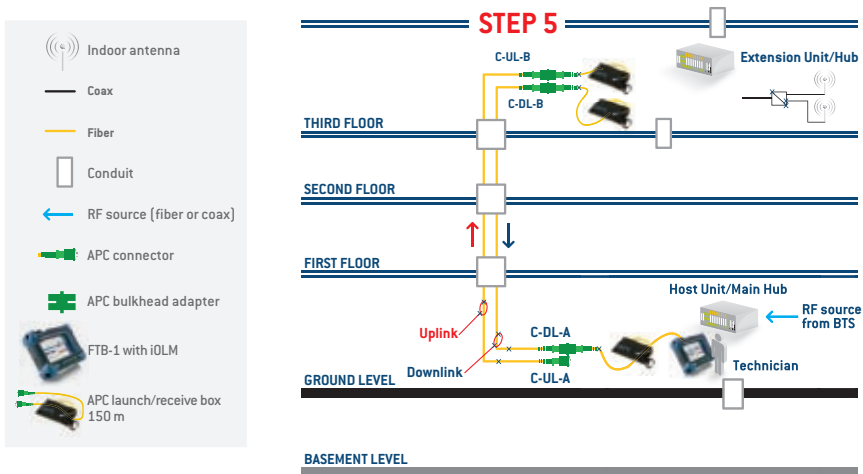

Figure 38 – One technician: Unidirectional downlink characterization

## Bidirectional Characterization of the Uplink and Downlink

This scenario can be accomplished by one technician equipped with the following:

- > 1x FIP-400 with cleaning kit
- > 1x FTB-1 with ConnectorMax software and an iOLM module
- > 4x SPSB with the appropriate connector interface

Characterization Parameters	Uplink Fiber		Downlink Fiber	
	END A	END B	END A	END B
Connector	Yes	Yes	Yes	Yes
IL	From A to B From B to A		From A to B From B to A	
ORL	View from A View from B		View from A View from B	

Table 14 — Characterization parameters provided with unidirectional testing

### STEPS 1 to 5

Steps 1 to 5 are identical to those indicated in the the previous test scenarios, with the addition of the two following steps:

- 6- Once the tests are completed at end A, the technician installs the received box at end A.
- 7- Go to end B to perform iOLM testing from end B to end A on both the UL and DL fibers. The technician should perform the same actions as those indicated in step 4 and 5 of the previous examples in order to conduct the test in the opposite direction.

## Two Technicians: Unidirectional Characterization of the Uplink and Downlink

The characterization parameters provided with unidirectional testing are identical to those indicated in Table 14; however, the overall time needed to complete a given job will be shorter, because the two technicians will not have to change locations.

For this scenario, we will assume that the iOLM test is being performed from end A.

The recommended equipment needed to conduct this characterization with two technicians is as follows:

Technician 1 (located at end A)

- > 1x FIP-400 with cleaning kit
- > 1x FTB-1 with ConnectorMax software and an iOLM module
- > 1x SPSB with the appropriate connector interface

Technician 2 (located at end B)

- > 1x FIP-400 with cleaning kit
- > 1x FTB-1 with ConnectorMax software
- > 1x SPSB with the appropriate connector interface

## STEP 1 – Connector inspection

Both technicians should inspect all of the connectors (as demonstrated in section 3.1.1 Connector Maintenance) of the fibers to be tested; in our example, the technicians will be simultaneously inspecting connectors C-UP-A, C-DL-A, D-UP-B and D-DL-B. The results should be saved with the right documentation (e.g., the correct Cable ID and Fiber ID).

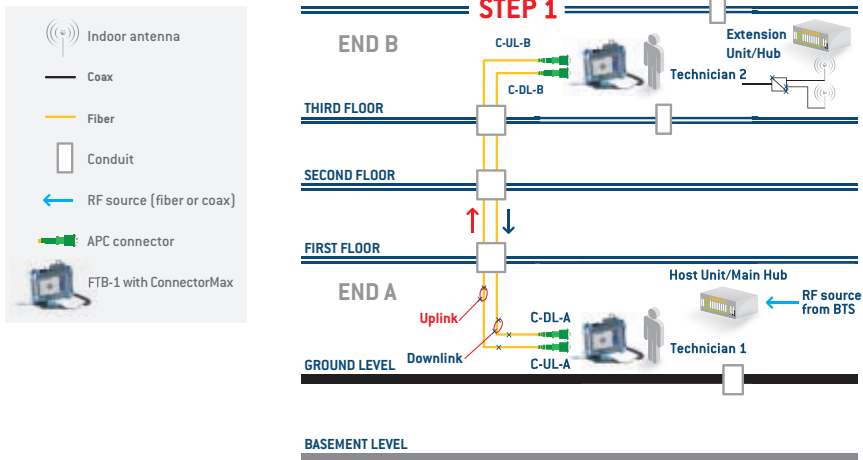

Figure 39 – Two technicians: End A and B connector inspection

## STEP 2 – Installation of the launch/receive box and the UL fiber test

Once the connector has been inspected and meets the acceptance criteria, technician 2 will connect the launch box to the UL fiber, while technician 1 will connect one end of the launch box to connector C-UL-A, and connect the other end to the iOLM port (as shown in Figure 40). Once the FTB-1 is connected, the technician simply presses start to launch the acquisition. Once the acquisition is completed, the results should be saved with the right documentation (e.g., the correct Cable ID and Fiber ID).

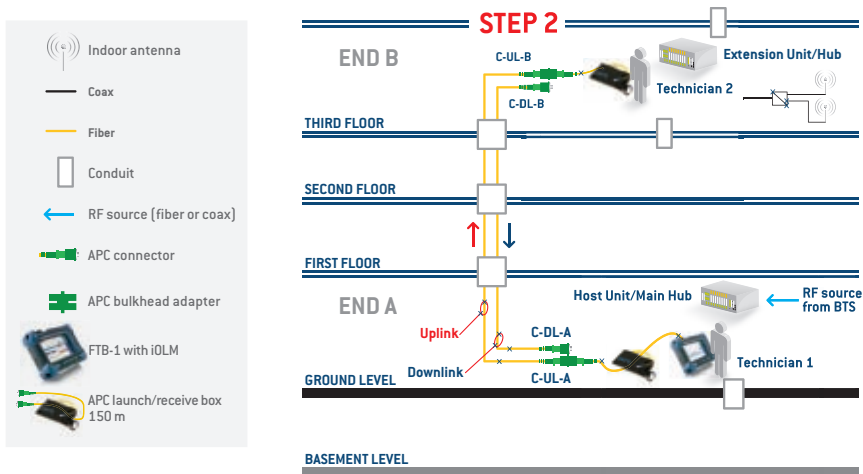

Figure 40 – Two technicians: Preparation for unidirectional UL fiber testing

### STEP 3 – Installation of the launch/receive box and the DL fiber test

NOTE: Because all of the connectors were previously inspected in STEP 1, the technicians should not have to re-inspect the connector. If there are doubts as to whether there could be any connector contamination, the technicians should re-inspect the connector to ensure that it still meets the acceptance criteria. Both technicians should follow the procedure as described in step 2, but this time apply it to the DL fiber (as shown in Figure 41).

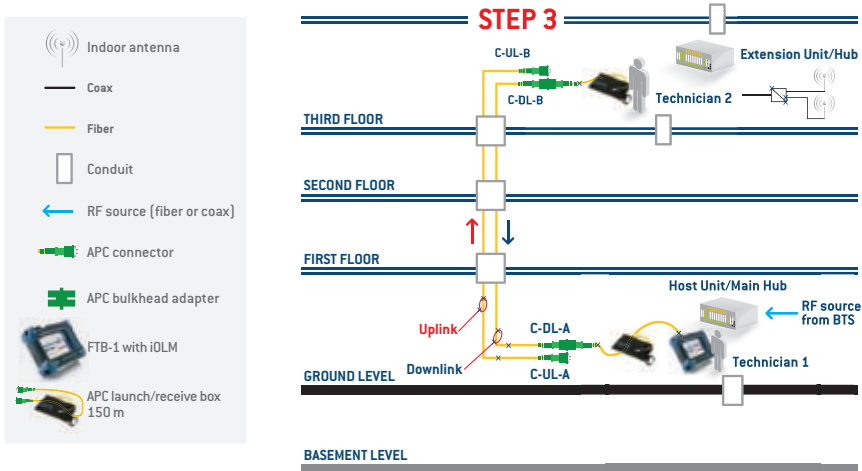

Figure 41 – Two technicians: Preparation for DL fiber testin



## **Bidirectional Characterization of the Uplink and Downlink**

The characterization parameters provided with bidirectional testing will be identical to those indicated in Table 14; however, the overall time needed to complete a given job will be shorter, because the two technicians will not have to change locations.

Technician 1 (located at end A)

- 1x FIP-400 with cleaning kit
- 1x FTB-1 with ConnectorMax software and an iOLM module
- 2x SPSB with the appropriate connector interface

Technician 2 (located at end B)

- > 1x FIP-400 with cleaning kit
- > 1x FTB-1 with ConnectorMax software and an iOLM module
- > 2x SPSB with the appropriate connector interface

### ***STEP 1 – Connector inspection***

Step 1 will be identical to the step 1 indicated in the previous test scenarios.

## STEP 2 – Installation of the launch/receive box and the UL fiber test

Both technicians will connect the launch/receive box on the fiber to be tested. For this example, we will start with the UP fiber. Technician 1 will start the test from end A to end B, and then save the result with the right documentation (e.g., the correct Cable ID and Fiber ID). To facilitate post-processing, it is recommended that you save this result by indicating AB in the file name, or that you use AB as a tag in the iOLM setup.

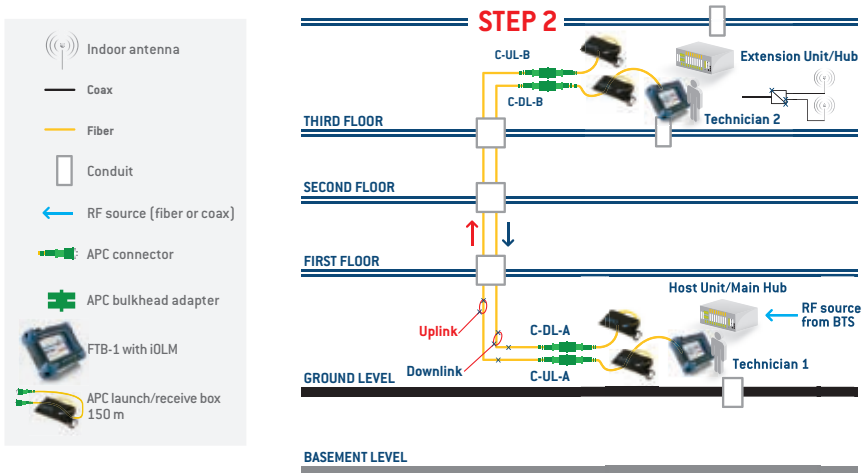

Figure 42 – Two Technicians: Preparation for bidirectional UL fiber testing

While the technician 1 is completing the test, the second technician can initiate the test on the other fiber, and then save the result using the same documentation as technician 1. To facilitate post-processing, it is recommended that you save this result by indicating BA in the file name, or that you use BA as a tag in the iOLM setup.

**NOTE:** For optimal results should bidirectional analysis be conducted in post-processing, it is important for both technicians to use the same test parameters.

### ***STEP 3 – Installation of the launch/receive box and the DL fiber test***

To test the downlink fiber, the technician should follow the same procedure specified in step 2. Once the test is completed, both technicians can move on to the next pair of uplink and downlink fibers.

#### 3.1.5 Alternative Methods

There are alternative test methods for characterizing fiber optic loss budget in a DAS. One of these techniques consists of using a standard optical power meter (OPM) and light source (OLS). For this testing technique, the OPM is used at one end of the fiber and the OLS is used at the other end (as demonstrated in Figure 43). The two units must be referenced before the test is performed. Referencing consists of subtracting the loss caused by the test setup components (test jumpers) from the overall loss measured during the test. The final result represents the loss inserted by the system under test alone.

In order to fully characterize the fiber loss in both directions, the OPM and OLS will need to swap locations, and the test results must be saved accordingly.

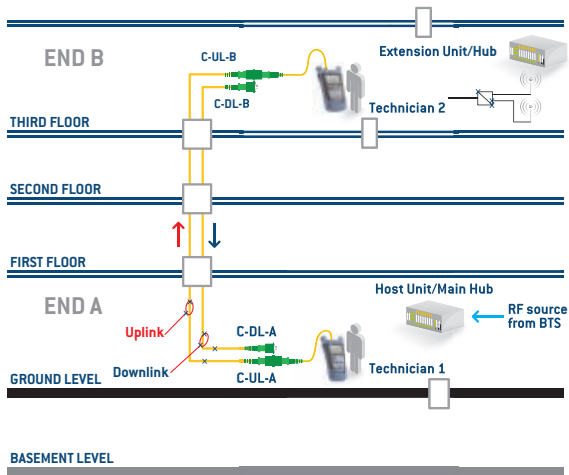
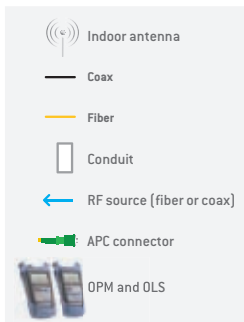

Figure 43 – Loss testing using an OPM and OLS

Another alternative test method involves the use of an optical loss test set (OLTS). Simply put, an OLTS is a measurement instrument that includes both an optical power meter and an optical light source, and is used to determine the total amount of loss or attenuation in a fiber span under test. As with a standard OPM and OLS, referencing needs to be performed prior to the test.

To perform the measurement, one of the technicians must connect the fiber under test to his or her OLS port, and the other technician must connect the same fiber to his or her OPM port.

One advantage of measuring loss using an OLTS is that you can obtain bidirectional test results without having to change the location of the instrument. This will decrease the testing time in relation to the method using traditional OPM and OLS. This will also provide loss in one direction; to obtain loss in the other direction, the technicians will need to connect the fiber under test to the other port of the instrument.

Automated OLTS (such as the FOT-930) are also available on the market. The main particularity of those OLTS is that they combine the OPM and the OLS in the same port. This enables the test instrument to perform the bidirectional test without the need for the test port to be changed. In just one step, technicians can be performing bidirectional testing. Some of these advanced OLTS will also provide measurement, the ORL, and the length of the fiber under test.



Figure 44 – OLTS top view

Even though these alternative methods do allow for loss characterization, they will not provide any mapping of the fiber under test, nor will they be able to locate faults. In addition, another instrument such as an iOLM or OTDR will be needed to perform these tests. Table 12 – Automated OLTS technological comparison highlights the main differences between the use of an iOLM or OTDR, and an automated OLTS.

Characteristics	OLTS	OTDR	iOLM
Number of technicians required	1	1	1
Technical expertise needed to perform test	Low	Medium to high	Low
Number of acquisitions/tests per fiber	1	An average of three to fully characterize all elements. Each acquisition is estimated at an average of 45 s/wavelength	Average of 45 seconds, includes all wavelengths
Average test time per fiber*	10 to 15 seconds	2.5 minutes	45 seconds
Physical mapping of the link	No	Yes	Yes
Graphical representation of the link	No	Traditional graphical representation	Link view
Provides insertion loss	Yes	Yes	Yes
Provides optical return loss	Yes	Yes	Yes
Provides length of the fiber	Yes	Yes	Yes
Automatic diagnostics	No	Yes, but limited (macro bend detection)	Yes
Troubleshooting	No	Yes	Yes
Live testing	No	Yes	Yes
Offers easy transpose fiber detection	Yes	No	No

Table 12 — Automated OLTS technological comparison

## 4.0 Troubleshooting a Live System

The first step when troubleshooting a live system is for the technician to identify the type of failure (i.e., to determine whether it is a system, patch panel or installation-related problem). Once the type of failure has been determined, proper action can be taken to remove the failure from the system. The following section assumes that the issue is related to the optical physical layer.

If a break occurred on a whole fiber cable between the head-end and the remote unit, and a whole sector would be affected, it would therefore be easier to find the exact location of the fault/break.

However, if a problem like macrobends or dirty connectors causes optical power loss somewhere in the network, only one antenna may be affected, making fault isolation more difficult. The logical steps in isolating the fault would be to determine which fiber (s) has or have a problem, to identify the type of issue (macro bend or bad connector), and to then locate the fault along the fiber. Once this is done, proper actions (e.g., cleaning the connector, removing the macro bend and replacing the jumper or changing the fiber section) must be taken to resolve the problem.

The last thing the technician wants to do is disconnect a working (good) live fiber, and to shut down the cellular services of an antenna or entire sector. Therefore, prior to disconnecting any fibers, the technician must validate which fiber is linked to the failure. To facilitate this task, the technician can use the LED alarms located on the small form-factor pluggables (SFPs) or on the host/expansion unit (HEU) in order to locate faulty links or antennas without signals. This will be valid in the case of a total failure of the fiber (e.g., a fiber break or high macro bend); however, the issue may at times be intermittent, in which case isolating the faulty link may require more sophisticated tools, such as a monitoring tool.

## 4.1 Tools That Can Be Used to Troubleshoot a System

### Inspection Probe

As mentioned in some studies, issues related to the connector (e.g., connector contamination) are often the first cause of network failure. An easy way to validate the condition of a connector and ensure that it is clean is to inspect it using a video inspection probe. As mentioned in section 3.1.1 Connector Maintenance, the video inspection probe can be used along with automated analysis software to help establish the right diagnostic (as per standards).



### Cleaning Tool

Once a contaminated connector has been identified, specialized cleaning devices will be needed in order to remove the contaminant (refer to section 3.1.1 Connector Maintenance for more details on connector cleaning).

### Visual Fault Locator (VFL)

As described in section 2.2.2 Macrobends and Their Effects, macrobends can lead to network failure. An easy way to visually locate the exact location of a macrobend (e.g., in a patch panel) is to use a VFL, which is a small handheld device used to inject a highly visible laser light into a fiber in order to detect bends, faults, continuity or port identification.





## Power Meter

In most cases, measurements in fiber optics refer to optical power. But, there is an important distinction to be made between “absolute” and “relative” optical power measurements. The first is a POWER measurement, whereas the second is a LOSS measurement (absolute POWER/relative LOSS).

## Relative power measurement

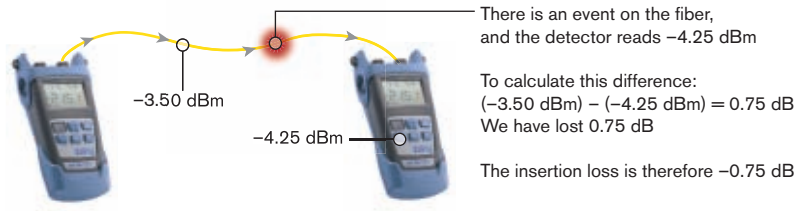

Figure 45 – dB (relative): The difference between two power measurements

Loss is a “relative” power measurement, i.e., the difference between the powers coupled into a component like a cable or a connector, and the power that is transmitted through it. This difference is what we call optical loss.

## Absolute power measurement



Figure 46 – dB (absolute): Measure the output power of a light source

Simply put, power at the output of a transmitter or at the input of a receiver, where you measure the actual value of the power, is an absolute optical power measurement. This is the type of power measurement that will be used to validate the output power of the transmitter to see if it is issuing the right amount of power into the system.

## Specialized Live Fiber Identifier

These devices help technicians identify a specific live fiber without having to disconnect it. Unlike traditional live fiber detectors, these specialized tools (e.g., the TG-300B/LFD-250B) do not lead to network outages caused by inadequate fiber detection or identification; they also minimize the need to access the network, thus helping to prevent errors. In comparison with other live fiber detectors, these specialized detectors monitor the loss as a function of the bending angle, and stop the bending when the signal is sufficient for decent and reliable detection. As such, the angle of bending is not fixed, but rather dependent on the wavelength and fiber. This approach enables us to address the needs of low insertion-loss requirements, and will work on low-loss high-bend radius fibers, where traditional detectors cannot be used. Figure 47 – Test scenarios using the FiberFinder test kit shows a few examples of the situations that these specialized tools were designed for.

Performing network upgrades or troubleshooting requires that the fiber be disconnected. This is often easier said than done, because finding the right connection can be tricky on account of mislabeling or poor record keeping. While the dark fiber can be identified using a tone generator (270 Hz, 1 kHz, 2 kHz), the live fiber identification technique often involves one technician pulling one end of the patch cord while another technician tries to identify which patch cord is moving at the other end—a process which translates into long delays that can result in unnecessary service disruption.

Combined with the TG-300B Tone Generator, the LFD-300B enables technicians to identify a specific live fiber without having to disconnect it, and above all, without any guesswork involved.



### Pinpointing a dark or a live fiber



### Pinpointing a specific dark fiber using a modulated light source

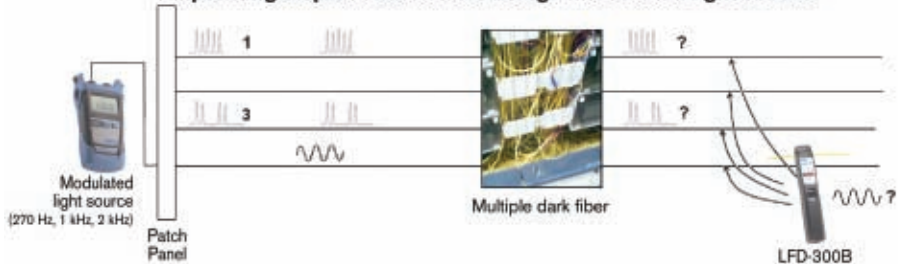

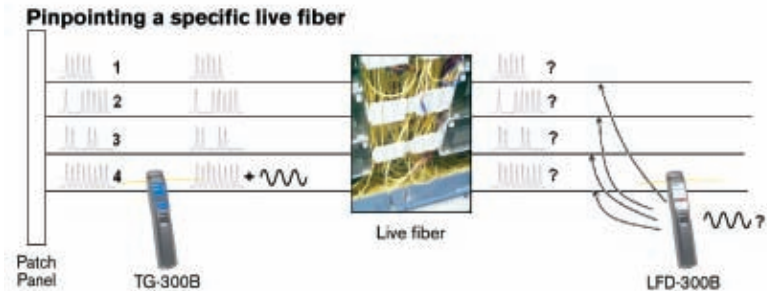

Figures 47 – Test scenarios using the FiberFinder test kit

## OTDR and iOLM

These instruments are often the first considered in troubleshooting situations. As mentioned in section 3.1 Construction, one of the advantages offered by testing techniques based on reflectometry is that they perform mapping of the fiber being tested. The capacity to quickly obtain the distance to the fault (find a bad connector, fiber break or splice) is critical in troubleshooting situations where the network is down and the network owner (e.g., the neutral host provider) could face SLA penalties from the service provider.

## 4.2 Troubleshooting Process

The troubleshooting process recommended below is simply one example of the different steps a technician could follow to solve fiber-related issues in a DAS environment.

- 1- Identify and located the defective fiber.
- 2- Isolate the defective element:
  - a. The transmitter (Tx) does not provide enough power.
  - b. The fiber has exaggerated loss.
  - c. The receiver (Rx) is not working properly.

## 4.2.1 Fiber Troubleshooting

Once the faulty fiber pair has been identified, the first step is to validate the output power of the transmitters.

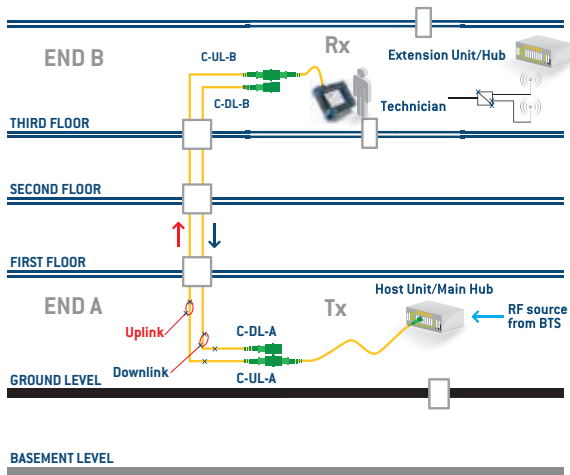
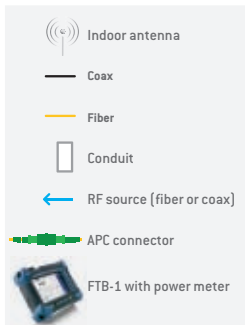

Figure 48 – Power measurement at the Rx location

If the powers are as per specification, the problem is than mostlikely related to the fiber. To save time troubleshooting the issue on the fiber, we recommend using an iOLM (or OTDR), which will provide loss/reflectance information for all of the elements on the fiber, and also pinpoint any element that fails the system requirements.

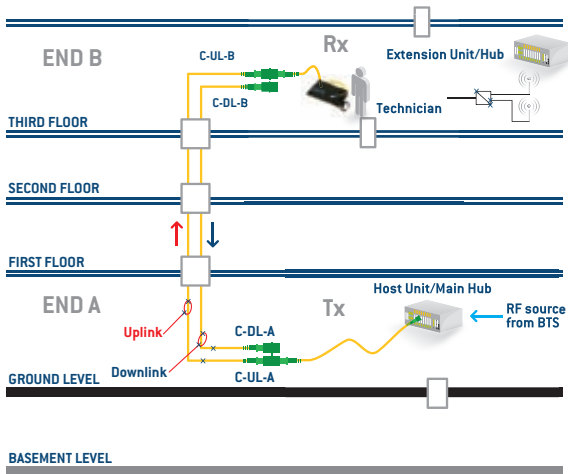
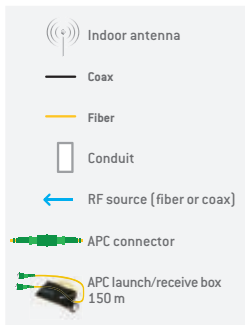

Figure 49 – Connecting the receive fiber at the Rx



To fully characterize each element (including the far-end connectors), the technician should connect a receive fiber, as shown in Figure 49, and then proceed to the Tx location. Once at the Tx location, the technician should connect the launch fiber as shown in Figure 50, and then perform the iOLM (OTDR) test.

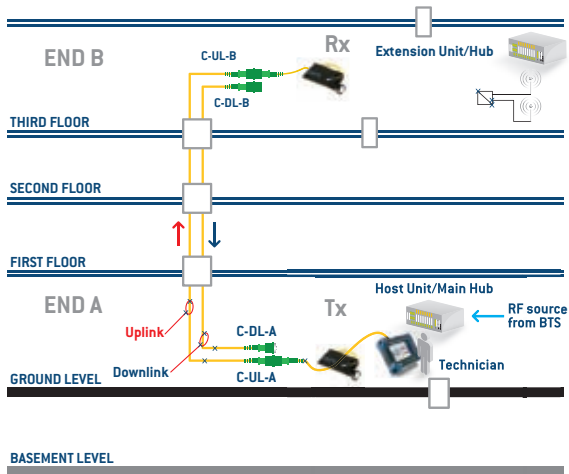
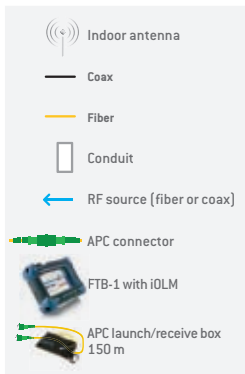

Figure 50 – Performing the iOLM (OTDR) test from the Tx

Once the test is completed, you can refer to the result sections for information about the fault potentially present on the fiber. The table below lists a few of the faults that could lead to system failure.



Type of Fault	Diagnostic	Solving the Issue
Bad connector 	The connector or bulkhead is damaged, dirty or not well connected.	Inspect and clean as needed.
Macrobend 	Excessive fiber bend	Inspect the fiber in this area for excessive bending. Use of a VFL could help identify the exact location of the macrobend.
Bad splice 	Excessive loss of a non-reflective fault	Inspect the splice at this location, and respliced if needed. Use of a VFL could help identify the exact location of a bad splice.

Table 13 —Type of fault

## 5.0 Test Documentation

Although network test documentation facilitates the planning and expansion of network capacity (bandwidth and routing), most often the need for documentation is only considered when an actual problem occurs. However, when the network is down, productivity is usually lost, meaning that customers/clients may not receive support, which could in turn lead to high loss of revenue. Having network documentation readily available enables the team in charge of resolving the issue to gain an understanding of the network while minimizing the time needed to fix it, thus translating into lower costs for you and your customers. However, good documentation is not only useful when a problem occurs; it also facilitates internal and external transfer of knowledge.

Another aspect to consider is that a lot of networks are built by contractors or subcontractors, who usually have to provide test reports in order to complete the job and to receive pay. It is therefore mandatory for them to save the test results of the work performed in the field.

At times, measurements gathered in the field will not require extra post-processing, but in most cases extra processing will be needed in order to perform proper analysis, establish accurate diagnoses, and ultimately document (test report or birth certificate) the network appropriately, as per customer requirements or the network owner's standard. The three logical steps (Table 12) in data post-processing generally consist of editing, analyzing and documenting the test results.

1. Edit	2. Analyze	3. Document
Adjust the cable and fiber parameters (e.g., job information)	Perform OTDR or iOLM bidirectional analysis	Report customization
Add/remove OTDR-iOLM events	Detect duplicated measurements	Various report types
Adjust detection thresholds	Easily identify the results that fail network requirements	Combined reports such as: > Fiber characterization > iOLM with connector inspection results
Perform manual measurements on OTDR files		
Set pass/fail thresholds		

Table 14 — Data post-processing actions

Performing the three steps outlined above on hundreds of measurements can be real challenge if your tools are not integrated (different software for different measurement types), or do not have batch processing capabilities. To help decrease the time spent on data processing, EXFO has developed FastReporter 2, which supports various measurement types, and offers batch capabilities and specialized reports (see figure 52). As such, FastReporter 2 can help cut reporting time in half in comparison to other reporting tools.

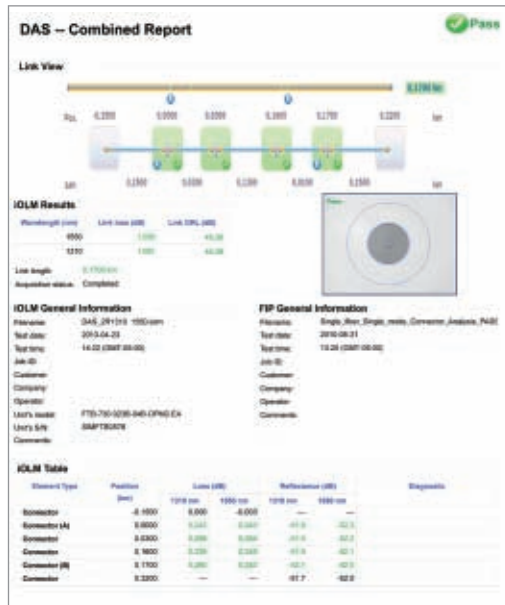

Figure 51 – iOLM and FIP Report

# Notes

---

---

---

---

---

---

---

---

---

---

---

---

---

---

---

---

## Acknowledgements

This guide would not have been possible without the enthusiasm and teamwork of EXFO staff, particularly the hard work and technical expertise of the Product Line Management team.

No part of this guide may be reproduced in any form  
or by any means without the prior written permission of EXFO.

Printed and bound in Canada

ISBN 978-1-55342-104-7

Legal Deposit-National Library of Canada 2013  
Legal Deposit-National Library of Quebec 2013

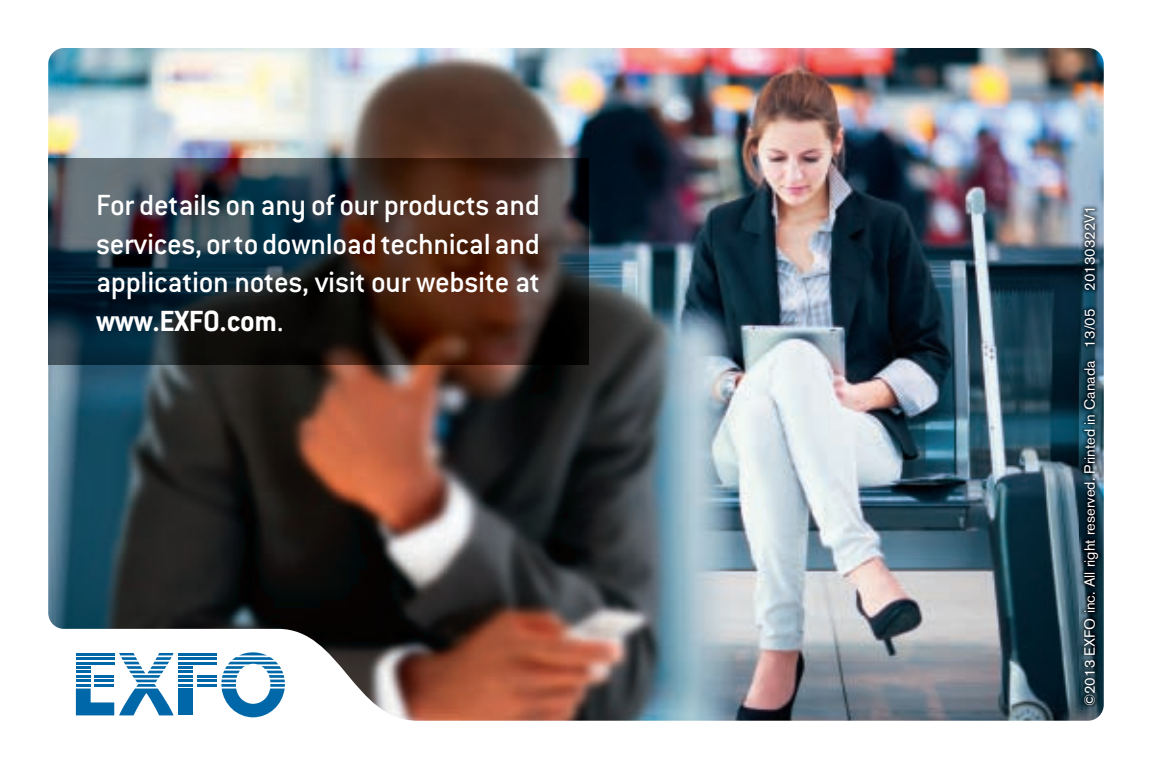

For details on any of our products and services, or to download technical and application notes, visit our website at [www.EXFO.com](http://www.EXFO.com).

**EXFO**