

RTU-2 – Remote fiber testing and monitoring

OTDR-BASED REMOTE TEST UNIT

- Centrally and remotely managed OTDR instrument for auditing, troubleshooting and continuously monitoring FTTx optical fibers.



KEY FEATURES

Smaller, denser and scalable hardware: combine modular and external switch (local or remote) to OTDR and scale up to 1024 ports per test head in as little as 3U rack height

Scalable EMS supporting over 1,000 remote test units in a single clustered instance

Fast & accurate: guaranteed HRD testing performance – 5 seconds on typical PONs with 60 cm HRD separation using high-end OTDR modules powered by market-leading iOLM application

Software architecture enabling automated and integrated workflow (e.g., iOLM, FMS, API)

Most secure solution: IOT type RTU, mutual SSL authentication

Cloud native architecture for integration in private and public clouds

MPO connectors: 16x fewer connectors for faster handling and scalability aligned with OLT card port counts

APPLICATIONS

Versatile solution throughout network lifecycle, from build to monitor, and across network topologies (e.g., PON, P2P, distributed access)

End-to-end continuity and loss verification in PONs

Massive FTTx network auditing

Automated troubleshooting of fiber-related issues

Preventive tracking of degradations

Restore and repair quality assurance

RELATED PRODUCTS



MEMS optical switch module
FTBx-9160
FTBx-9110



External MEMS optical switch
RTUe-9120
OTAU-9150



OTDR modules
FTBx-735C,
FTBx-750C



OTDR/traffic WDM coupler
Test access module kit and MPO-based cassettes

REMOTE TEST UNIT COMPONENTS

Overview

Part of EXFO's solution for remote fiber testing and monitoring (RFTM), the RTU-2 is a test unit that is remotely controlled via EXFO's central fiber monitoring system (FMS). It is a modular unit, hence allowing for flexibility and scalability. OTDR modules and optical switches enable centralized fiber characterization through patented OTDR/iOLM technology. Optical link management can be scaled up to 1024 ports with external optical switches (local or remote).

In-service testing and monitoring of P2P and PONs is possible thanks to in-service OTDR port at 1650 nm coupled with a traffic multiplexer (test access module coupler).

Finally, measure PON end-to-end fiber attenuation at 1650 nm with a traceable test method using a high-reflectance demarcation filter.

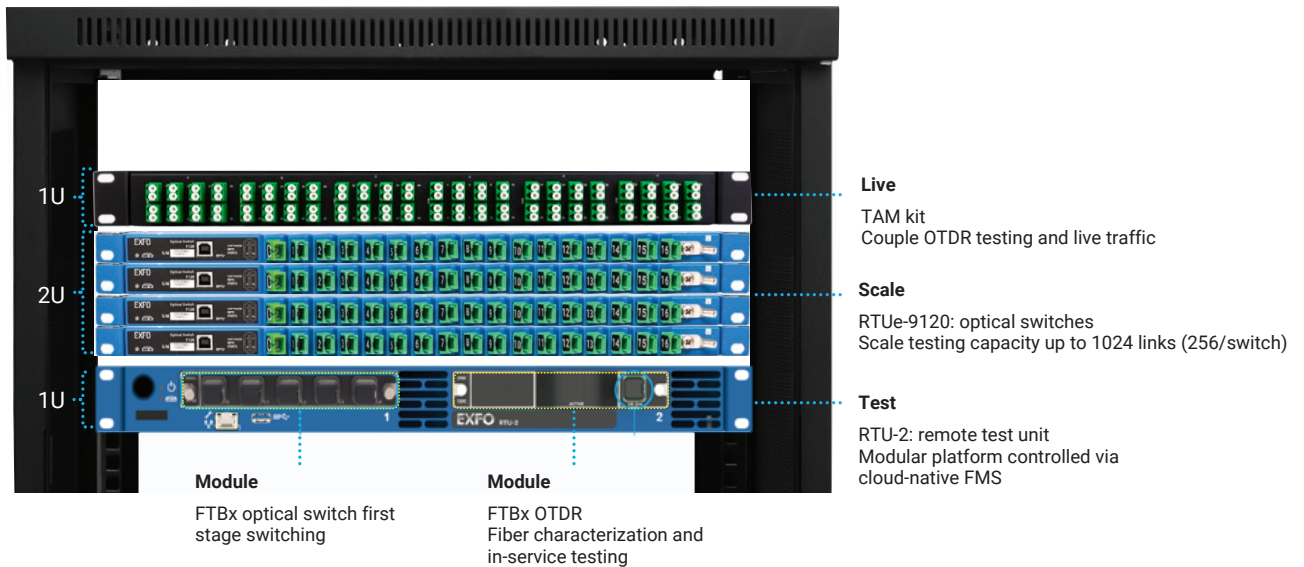

MAIN/CONTROLLER UNIT AND MODULES

RTU-2

The RTU-2 is a 1U modular rackmount platform for remote fiber testing and monitoring.



When paired with an FTBx OTDR module and an FTBx optical switch module, the RTU-2 can handle centralized testing and monitoring of P2P and PONs on either dark or live fiber.

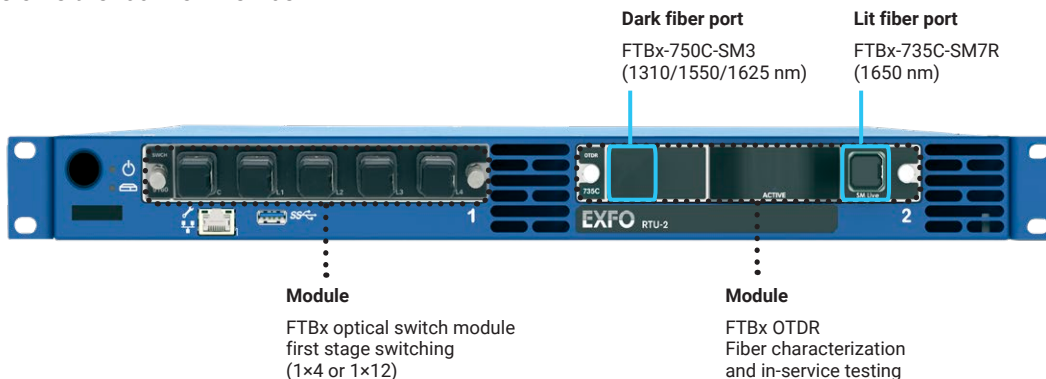

OTDR MODULES

FTBx-700C series

FTBx-700C series OTDRs are high-resolution OTDRs. The FTBx-735C is designed for metro/PON network testing and splitter characterization in PON FTTx applications. The FTBx-750C-SM3 is a 3-wavelength OTDR for dark fiber characterization and monitoring, suitable for links ranging from short to long haul owing to its 45 dB dynamic range.



| KEY FEATURES | FTBx-735C-SM7R | FTBx-750C-SM3 |
|---|------------------------|-------------------|
| Wavelength | 1650 nm | 1310/1550/1625 nm |
| Reflectometry: characterizes, evaluates or audits fiber quality | • | • |
| In-service testing | • | |
| Tone generation identifies the fiber | (including in service) | • |
| HRD testing certifies the link end-to-end for PON architectures | • | |

KEY OTDR-iOLM CAPABILITIES FOR PON

End-to-end loss (EEL) measurement

A practical function of the iOLM is its ability to measure end-to-end loss or optical attenuation between the OTDR's location, in this case the central office, and any connector port downstream—even when a port is beyond a series of splitters. By simply splicing or inserting a **high-reflectance demarcation (HRD)** filter and using a mobile smart app, link characterization can be done within 10 seconds.

Key information and values:

- Confirmation of proper upstream connectivity
- Loss and expected loss budget (dB) at the measured point of the network
- Optical fiber length-correlation with network documentation

In Figure 2, the attenuation is measured from the node to any connection terminal using the RTU-2 OTDR and HRD filter. This is performed by a field technician who is testing on one or every port of a second-stage splitter during network installation or when certifying a contractor's work.

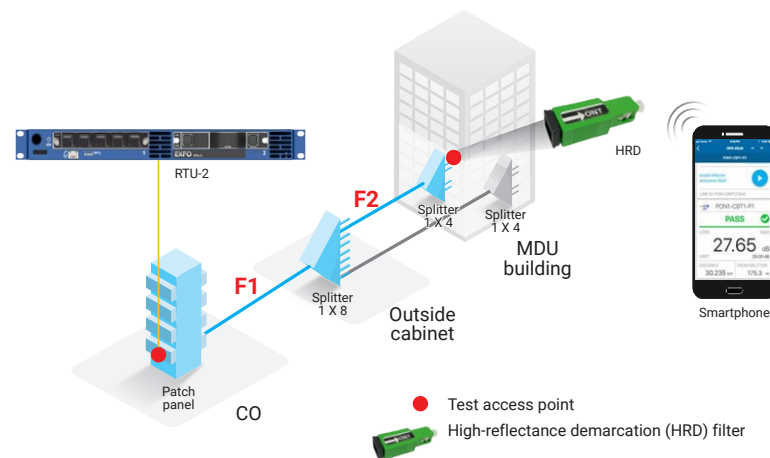

Figure 2. Link certification in a PON architecture with end-to-end connectivity.

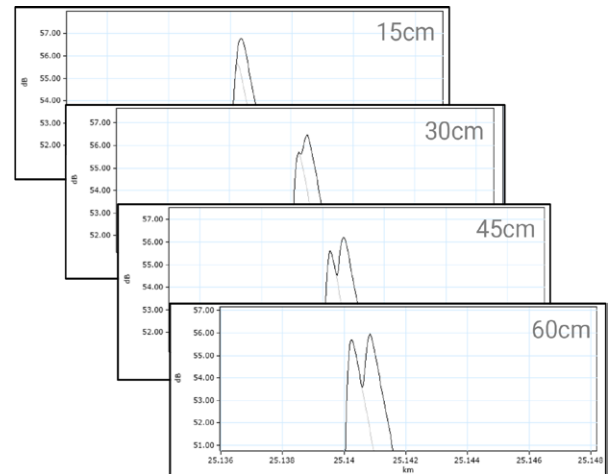

Figure 1. High-resolution demarking of PON termination ports capability using HRDs down to 60 cm.

MERGING OTDR AND iOLM CAPABILITIES

Link-Aware™ technology: simplify OTDR tests

Simplify and optimize the test run. In one click, the test unit automatically performs link recognition, sets the optimal parameters and launches multiple acquisitions. It then consolidates the results for every link event, section and splitter (if any). The iOLM software removes front-end events, like optical switches, that are part of the test setup to only keep and report the relevant part of the test.

The unit provides accurate data such as position, loss and reflectance on all elements and displays an easy-to-read result for any NOC or field technicians. The smart iOLM software yields N single OTDR traces that can be verified and compared with their respective baseline, allowing second and third-tier support to analyze further into these acquisitions.

HOW DOES IT WORK?

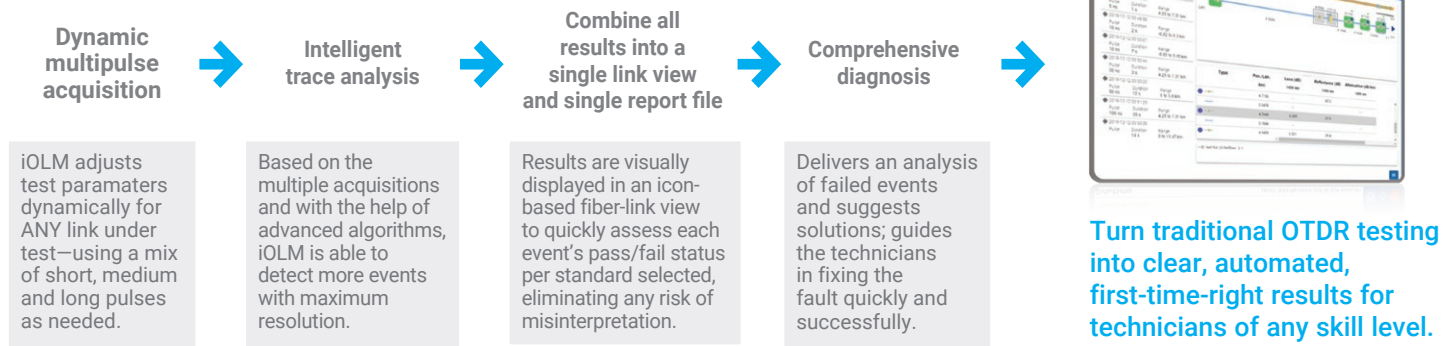

Three key advantages of the OTDR-iOLM

- 1** No calibration needed for end-to-end loss measurements
- 2** Accuracy of single-ended end to end loss similar to light source—power meter technique
- 3** Long-term stability of the end-to-end (to HRDs) measurement in monitoring

Tone generator

It can be daunting to pinpoint a specific live fiber, untangle fiber mislabeling or deal with poor record-keeping.

The FTBx OTDR can generate a tone signal to work in conjunction with the live fiber detector in the field. The tone signal is triggered via a smartphone-based application. It communicates with the FMS server to request the tone generated signal to enable the fiber identification process for a time period that can be set.

This avoids costly downtime/network outages and minimizes the need to access the network, thus avoiding errors.

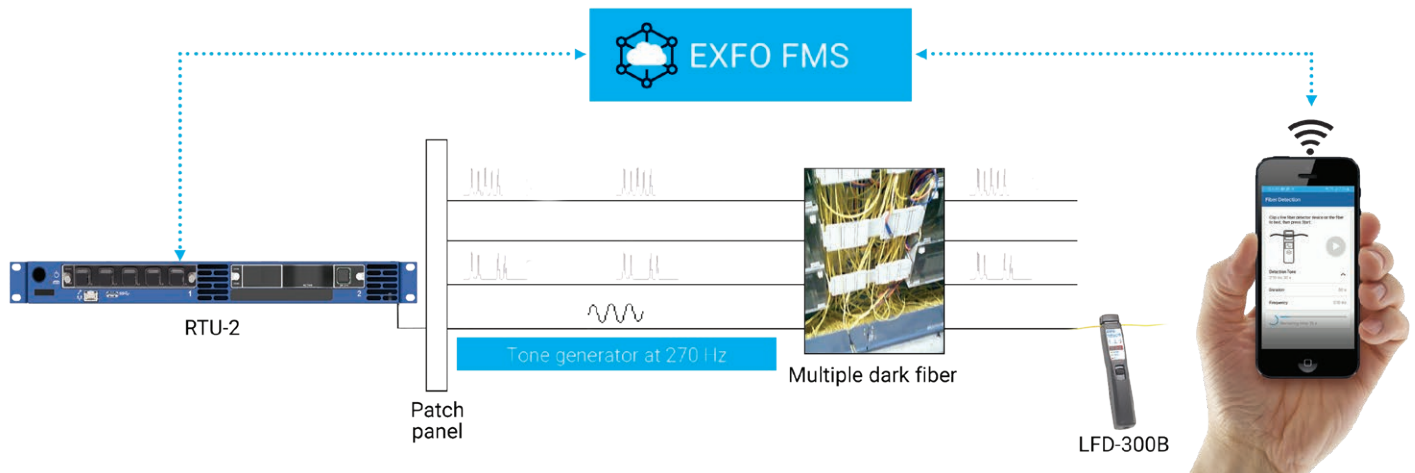

Figure 3. Source/tone mode for fibre identification.

OPTICAL SWITCHES: SCALING REMOTE TESTING CAPABILITIES

Module: 1×N FTBx optical switch

With its MEMS-based design, the FTBx optical switch delivers durable performance in a compact package. Fast switching time and a 1-billion-cycle lifetime expectancy make it ideal for the demanding needs of production testing and monitoring applications. The FTBx MEMS optical switch is available for singlemode fibers with a choice of 1×4 and 1×12 modules.

As a first stage switching of the RTUe-9120 external switch or to the OTAU-9150 remote switch, the setup can provide 1024 different optical paths to test.



Local expansion unit: external 1×N optical switch RTUe-9120

Connect the OTDR module port directly to the common port of RTUe-9120 external optical switch unit for up to 256 ports in ½U rack height or add up to four units by first connecting the OTDR port to the common port of the 1×4 optical switch module, allowing up to 1024 ports.

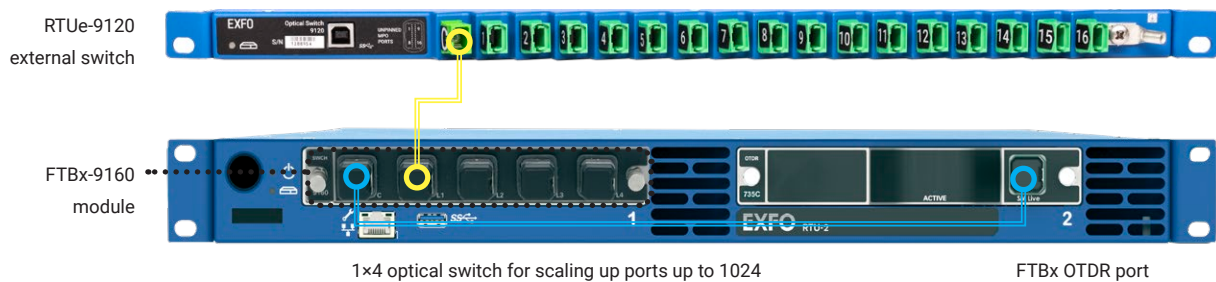

Local or remote expansion unit: 1×N optical switch OTAU-9150 with optional built-in live coupler

Broaden the reach of the RTU-2 by using the compact (½U rack height) OTAU-9150 switch, either locally or in any remote locations within the network: core, metro, access and FTTx/PON networks. For a cost-effective solution, leverage a single OTDR test head to supervise multiple links located at various edge sites.

Less fiber utilization to reach end point

The OTAU-9150 is available with up to 1×128 port count or with optional internal WDMs for live fiber monitoring. This switch achieves utmost port density and low insertion loss to meet tight optical loss budgets.

TEST ACCESS MODULE (TAM) FWDM KITS: TESTING LIVE NETWORKS

TAM/FWDM couples OTDR to line

TAM/FWDM is the optical coupling element, which is used in remote testing and monitoring applications to combine the OTDR signal with traffic.

The device used to perform this function is typically a coupler. Some are broadband-type, others are WDM-type or wavelength-division multiplexers, which are spectrally sensitive combiners. WDM couplers are available in low-density TAMK and also offered in dense MPO-based cassettes for up to 288 tested lines in 1U.



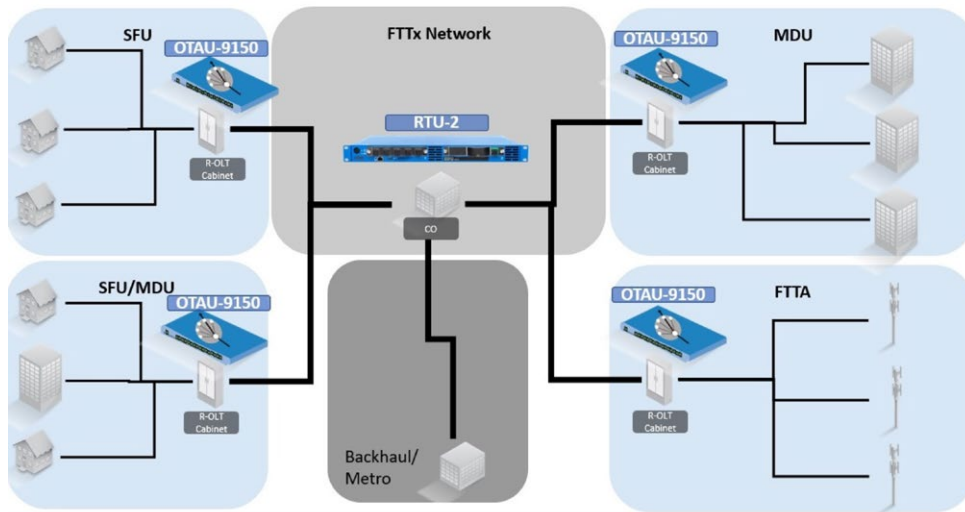

HOW IS THE RTU-2 INTEGRATED?

- RTU-2 platform is handled by the FMS, which is a scalable system that can control and manage up to 1000 remote test units with horizontal scaling capabilities
- RTU-2 platform is a true client requiring minimal outbound firewall to be opened for messaging-based communication using encrypted protocol
- Integration by third parties can be done from the FMS micro-services APIs offering the exact same functional capability of web and mobile clients (UIs)

ILLUSTRATION OF RTU-2 INTEGRATION

Key benefits

- Everything from every measurement is captured to feed analytics platform
- Support the usual OSS interfaces, alarms via SNMP and inventory connection via RESTful APIs
- Qualified for 1000+ probes under a single "EMS" instance
- API-ready backend unlocking system capabilities and how it can integrate
- Real-time data integrity and consistency in hybrid EXFO/customer applications

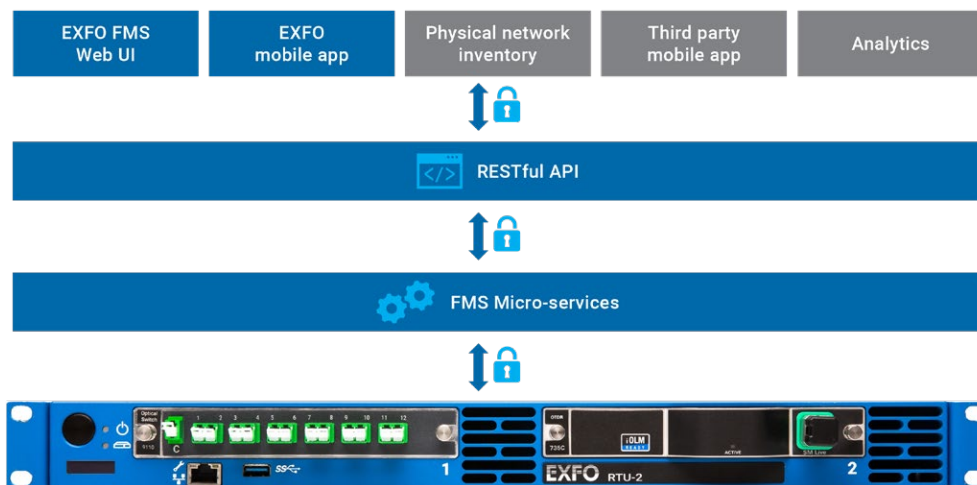

SPECIFICATIONS

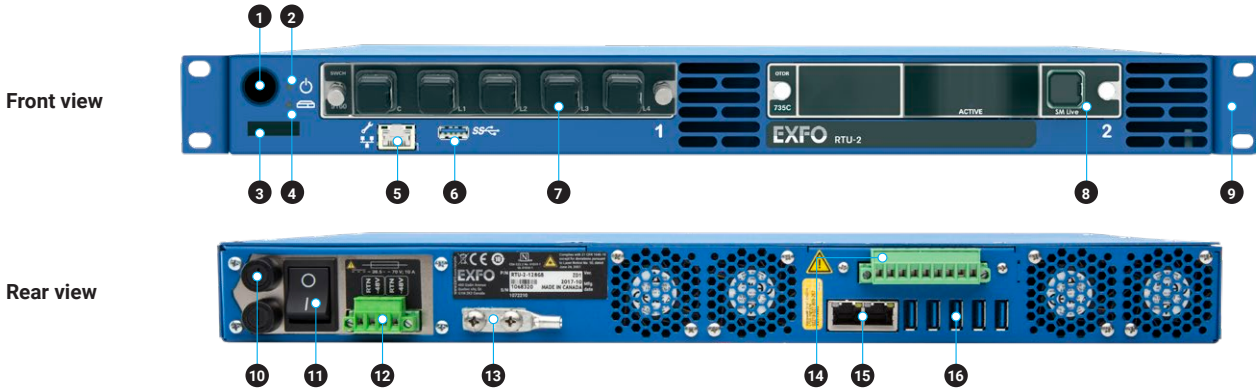







- 1 Power button
- 2 Power LED
- 3 System information display
- 4 System LED
- 5 Ethernet management port
- 6 USB 3.0 port
- 7 Module – Slot 1
- 8 Module – Slot 2
- 9 Removable rack mount brackets
- 10 –48V input circuit fuses
- 11 Main power switch
- 12 –48V dual feed input
- 13 Ground lug
- 14 Dry contact relays (3)
- 15 Ethernet ports
- 16 USB 3.0 ports (5)

Optional junction panel (all connections on front of panel)



PLATFORM SPECIFICATIONS

| | | |
|--|--|------------------------------------|
| Mainframe | Quad-core Intel i7 processor / 8 GB / Linux embedded | |
| Front interfaces | RJ45 10/100/1000 Mbit/s (management port) USB 3.0 | |
| Rear interfaces | RJ45 10/100/1000 Mbit/s (management + Ethernet ports) (2) USB 3.0 (5) Relay contact: 3 (power, system and user configurable) | |
| Storage | 128 GB SSD internal memory | |
| Power supply | –48VDC DC, 10A (ordering option: external AC-DC adapter for AC operation) | |
| Power consumption | Idle state | 25 W |
| | OTDR measuring | 40 W (typical) |
| Dimensions (H × W × D) (includes brackets) | 44 mm (1U) × 482 mm × 262 mm (1 3/4 in × 19 in × 10 5/16 in) | |
| Weight (includes brackets) | 5.1 kg (11.2 lb) | |
| Temperature | Operating | –5 °C to 50 °C (23 °F to 122 °F) |
| | Storage | –40 °C to 70 °C (–40 °F to 158 °F) |
| Relative humidity | < 95 % non-condensing | |

| REGULATORY | |
|---------------------|---|
| Certification marks |      |
| EMC/EMI | EN 61326-1 (Immunity Industrial level), EN 55011, CISPR 11, FCC 47 CFR Part 15, Subpart B, ICES-001, ETSI/EN 300 386 |
| Electrical safety | IEC/EN 61010-1, USA/UL 61010-1, CAN/CSA-C22.2 61010-1-12 |
| Optical safety | IEC 60825-1  |
| NEBS | GR-63-CORE, GR-1089-CORE ^a |
| ETSI | ETSI/EN 300 019-2-1, ETSI/EN 300 019-2-2, ETSI/EN 300 019-2-3, ETSI/EN 300 386, ETSI/EN 300 753, ETSI/EN 300-132-2 |

a. The equipment is NEBS-compliant based on Verizon VZ.TPR.9303 for test and measurement equipment-permanent installation for DC Powered, permanent installation type 2 equipment, and AT&T ATT-TP-76200 (Carrier Grade level 1). Contact Factory or visit the following URL for more details about this certification: www.verizonnebs.com/TPRs/VZ-TPR9303.pdf

| OTDR MODULES | FTBx-735C-SM7R | FTBx-750C-SM3 |
|---|-------------------------------|-------------------------------|
| Wavelength (nm) | 1650 | 1310/1550/1625 |
| Internal filter for in-service testing | Yes | No |
| Dynamic range at 20 μ s (dB) ^a | 41 | 45 |
| Event dead zone (m) ^b | 0.6 | 0.5 |
| Attenuation dead zone (m) ^c | 2.5 | 2.5 |
| PON dead zone (m) ^d | 30 | n/a |
| Sampling resolution – minimum value (m) | 0.04 | 0.04 |
| Sampling points | Up to 256 000 | Up to 256 000 |
| HRD measurement time (s) ^e | 5 | n/a |
| HRD measurement loss range (dB) | 11 to 35 | n/a |
| HRD minimum distance separation (m) ^f | 0.6 | n/a |
| First splitter to HRD maximum distance (km) | 8 | n/a |
| Source mode tone frequencies (Hz) | 270, 330, 1000, 2000 | 270, 330, 1000, 2000 |
| MEMS OPTICAL SWITCH MODULES | FTBx-9160 | FTBx-9110 |
| Number of output ports | 4 | 12 |
| Operation wavelength range (nm) | 1290-1650 | 1260-1650 |
| Insertion loss at 1530 nm - 1650 nm (dB) ^g | 0.7 | 1.6 |
| Lifetime in cycles | >1 billion (10 ⁹) | >1 billion (10 ⁹) |
| Interface | SC-APC | LC-APC |

a. Typical dynamic range with three-minute averaging at SNR=1.

b. Typical for reflectance from -35 dB to -55 dB, at 3-ns pulse.

c. Typical for reflectance at -55 dB

d. Non-reflective FUT, non-reflective splitter, 13-dB loss, 50-ns pulse, typical value.

e. Excluding networking latency – for a PON F2/distribution range of 4 km with nominal loss of 20 dB.

f. Typical, for similar level of attenuation between both.

g. Typical, including loss of one connector.

ACCESSORIES

| | |
|---------|---|
| GP-2256 | FTBx module slot blank cover |
| GP-3122 | External AC-DC 48 V power supply with power cord |
| GP-3123 | 19-inch rackmount brackets (kit of 2) |
| GP-2016 | RJ45 LAN cable (10 feet/3 m) |
| GP-3170 | 19-inch to ETSI rack extenders |
| GP-3162 | USB 3.0 client cable, 6 feet (2 m), right-angle connector |
| GP-3173 | Junction panel kit for front-sided connectivity |

ORDERING INFORMATION

RTU-2-XX-XX

Power input

DC = Internal DC 48V power supply

AC = External 48V DC dual input feed with power cord

Mounting method

00 = Standard mounting

JP = Front-sided connectivity

Example: RTU-2-DC-JP

FTBx-735C-SM7R-EA-EUI-91

Model

FTBx-735C-SM7R-EA-EUI-91 – 1650 nm, 41 dB, SC-APC

FTBx-750C-SM3-EA-EUI-91

Model

FTBx-750C-SM3-EA-EUI-91 – 1310/1550/1625 nm, 45/45/45 dB, SC-APC

FTBx-9160-01-04-B-88

Model

FTBx-9160-01-04-B-88 – MEMS-type optical switch module, 1×4, SC-APC

FTBx-9110-SPLX-12-B-104

Model

FTBx-9110-SPLX-12-B-104 – MEMS-type optical switch module, 1×12, LC-APC

Including a 1.5 m SC-APC/SC-APC FLEX-boot type jumper cable is included to connect OTDR module live port to optical switch module common port.

EXFO headquarters T +1 418 683-0211 **Toll-free** +1 800 663-3936 (USA and Canada)

EXFO serves over 2000 customers in more than 100 countries. To find your local office contact details, please go to www.EXFO.com/contact.

For the most recent patent marking information, please visit www.EXFO.com/patent. EXFO is certified ISO 9001 and attests to the quality of these products. EXFO has made every effort to ensure that the information contained in this specification sheet is accurate. However, we accept no responsibility for any errors or omissions, and we reserve the right to modify design, characteristics and products at any time without obligation. Units of measurement in this document conform to SI standards and practices. In addition, all of EXFO's manufactured products are compliant with the European Union's WEEE directive. For more information, please visit www.EXFO.com/recycle. **Contact EXFO for prices and availability or to obtain the phone number of your local EXFO distributor.**

For the most recent version of this spec sheet, please go to www.EXFO.com/specs.

In case of discrepancy, the web version takes precedence over any printed literature.