

DIGITAL FREQUENCY

LOCKING SYSTEM

5720

DFL-5720

R&D AND MANUFACTURING



- Peak, level and crosspoint locking modes
- Real-time input and error signal display
- Fully digital, DSP-based mathematical operator unit
- 16-bit, 19-kHz sampling-frequency I/Os
- Bipolar, low-noise voltage outputs

Intelligent, Flexible Locking-Process Technology

The stand-alone DFL-5720 Digital Frequency Locking System enables hassle-free optimization of locking processes. This flexible, comprehensive system provides high-stability, customized locking for virtually any measurable parameter, specifically the absolute emission/transmission frequency of lasers and optical filters.

Former methods for achieving locking processes were both costly and time-consuming. A common approach consisted in combining several individually programmed instruments, a complex and potentially troublesome method. Another method was to design a proprietary, limited-functionality, microprocessor-based PCB—requiring repeated modifications and updates, according to product and technology evolution.



Simple, Efficient Laser-Frequency Tuning and Control

EXFO's DFL-5720 supports three laser-source frequency-locking modes:

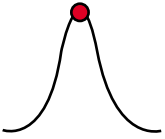
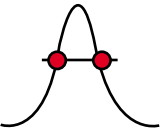
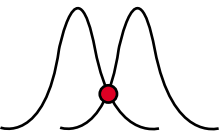
Peak	Level	Crosspoint
Uses standard frequency dithering and synchronous detection to lock at a maximum or minimum transmission peak.	Uses a simple level locking scheme to lock on the left or right side of a transmission peak.	Uses direct locking and real-time comparison to lock at the intersection of the responses of two filters.
		
peak	level	crosspoint

KEY FEATURES

EXFO's DFL-5720 Digital Frequency Locking System offers all the functionalities found in common instruments:

- Function generator producing a voltage saw-tooth function
- Programmable output voltage control
- Programmable loop filter
- Sine-wave modulation generator
- Digital lock-in amplifier
- 16-bit, 19-kHz sampling-frequency acquisition
- Oscilloscope mode for real-time signal display
- Ethernet port
- Visual Basic™ demo application

A Wide Range of Applications

Control a variety of processes with the DFL-5720. Connect it to the analog input of an external cavity laser (ECL)—a widespread device in tunable-laser-diode spectroscopy. Use the appropriate reference filter or gas cell, and maintain the laser-emission frequency very accurately over the entire measurement process.

You can also use the DFL-5720 to conduct fundamental research in physics or chemistry, or to study automated-system-based feedback loops. Typical applications include:

- Optical sensing
- Chemical reaction monitoring
- Gas-trace detection
- Pollution monitoring
- Saturation spectroscopy
- Raman spectroscopy
- Interferometry and holography
- Adaptive optics

A Trouble-Free, All-in-One Solution

Depending on the locking strategy selected, you can perform single or dual power measurements to characterize the optical filter's transmission pattern. These measurements can be delivered to the DFL-5720 inputs as voltages or photocurrents. The system can compute real-time ratios, differences, sums or products of these measurements, and use the results within the locking process:

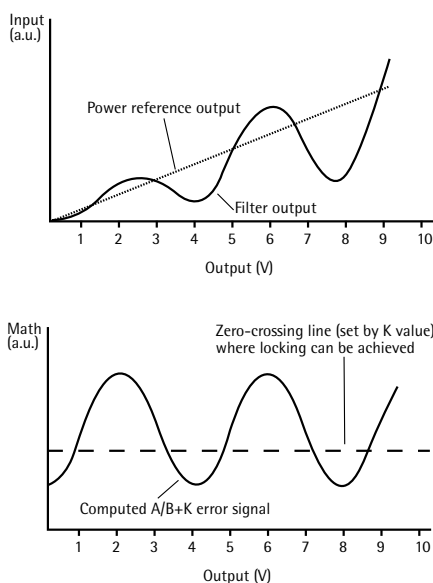

Peak Lock with Digital Lock-in Amplifier

The long-term stability achieved with level locking can be sensitive to environmental changes that affect the reference filter's shape or slope. Peak locking usually provides better long-term locking performance. By applying a weak and known (phase, frequency, amplitude) sine-wave signal to the DC part that controls the optical frequency, it is possible to extract only the error relevant to a real shift and correct the DC level accordingly. The DFL-5720 offers the following lock-in amplifier features:

- Programmable amplitude and frequency up to 8000 Hz
- Synchronous detection up to the 15th harmonic
- Phase detection fine-tuning
- Possibility to apply AC modulation and correction signal on two different outputs

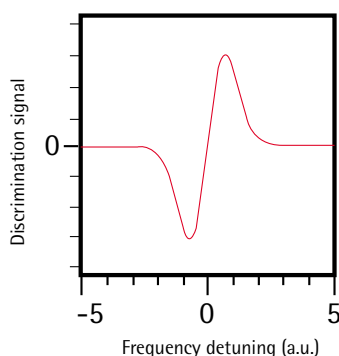

In addition to being a laser frequency locking system, the DFL-5720 lets you visualize the filter transmission pattern by sweeping the laser frequency with a programmable voltage ramp. Scroll through the transmission pattern and select which edge or peak to lock onto. The DFL-5720 works a lot like a standard oscilloscope, with the added advantage that the ramp boundaries dynamically follow the set display window.

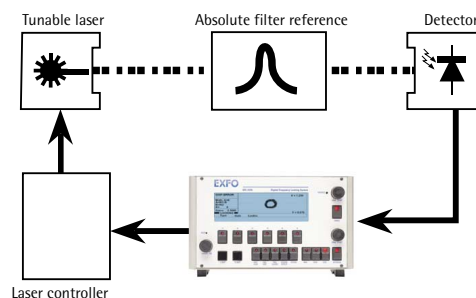

The DFL-5720's backlit LCD screen enables consecutive analysis of any of the three input signals, as well as of the error signal, as shown in figure below. Optimizing the error signal spreading around the target value is key in ensuring the best possible locking performance.

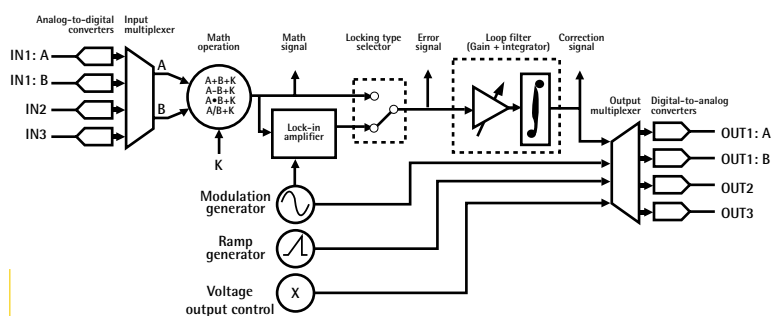
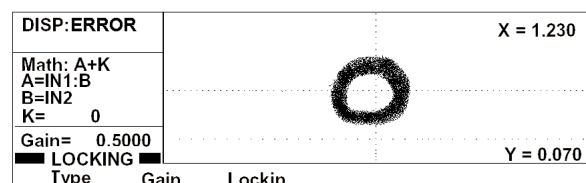

Functional-block diagram illustrating the DFL-5720's functionalities.

SPECIFICATIONS

Inputs

IN1, IN2, IN3	Single-ended, BNCs
Type (bipolar)	Voltage or transimpedance
Input impedance	
(V mode)	10 k Ω /2 nF
(I mode)	0 Ω (virtual ground)
Coupling ¹	AC or DC
AC input cutoff (Hz) typ.	160
Ranges ² (V, mA)	0.1, 1 and 10
Uncertainty ³ (accuracy) (%)	\pm 5 (full scale)
Linearity ⁴ (%) typ.	\pm 0.05
ADC sampling resolution	16 bits
ADC sampling Frequency	19 kHz

Outputs

OUT1, OUT2, OUT3	Single-ended, BNCs
Type (bipolar)	Voltage
Output impedance	50 Ω /1 nF
Ranges (V)	0.01, 0.1, 1 and 10
Uncertainty ³ (accuracy) (%)	\pm 5 (full scale)
Linearity (%) typ.	\pm 0.05 (full scale)
Noise ⁶ (mV rms)	0.2
DAC sampling resolution	16 bits
DAC sampling frequency	19 kHz

DC Power Supply

Level	+5 V (max. 50 mA)
-------	-------------------

Ramp

Waveform	Linear saw tooth
Repetition rate (Hz)	0.01 to 100
Number of points (display)	10 to 2048

Sine-Wave Generator

Frequency range (Hz)	10 to 8000
Setting resolution (Hz)	0.01
Amplitude range ⁷	0 to full scale
Ampl. set resolution (%) typ.	1 (full scale)
Harmonic distortion ratio ⁸ (%)	\pm 0.5

Lock-in Amplifier

Input	Math operator
Detection phase range (°)	0 to 360
Low-pass filter cutoff (Hz) typ.	500
Harmonic (up to 10 kHz)	Fundamental to 15 th

Digital Loop Filter

Type	Integrator (I)
Loop integral gain	
Range (s ⁻¹)	0.01 to 10 ⁸
Resolution (s ⁻¹)	0.01

Computer Interface

Ethernet port	10BaseT (RJ-45 cable not included)
RS-232	DB9 (NULL-modem cable not included)
Remote controls	SCPI, ActiveX, COM components and Visual Basic™ demo application

General Specifications

Power supply		
Voltage	110/220 V AC, 60/50 Hz	
Power	50 W	
Dimensions (H x W x D)	14.6 cm x 23.5 cm x 28.5 cm (5 3/4 in x 9 1/4 in x 11 1/4 in)	
Weight	3.0 kg (6.6 lb)	
Operating temperature	0 °C to 50 °C	
Storage temperature	-20 °C to 70 °C	

Notes

- IN2 and IN3 are only DC coupled.
- Selectable through rotary switch on back panel.
- Specified from 20 °C to 30 °C for all inputs except IN1: B with gain set at \times 1000. Typical temperature sensitivity of 3 x 10⁻⁴/°C.
- For signals from -90 % of full scale to +90 % of full scale. Characteristic value given in percentage of the 90 % full scale level.
- Specified from 20 °C to 30 °C for 1 V and 10 V ranges. Typical temperature sensitivity of 3 x 10⁻⁴/°C.
- Characteristic value over 20 Hz - 30 kHz bandwidth in open-loop output mode for the 0.01 V, 0.1 V and 1 V ranges.
- Amplitude is digitally programmable.
- Characteristic value around 1000 Hz modulation frequency with amplitude of 2 V_{pp}.

ORDERING INFORMATION

Model: DFL-5720

rackmount option: RK-4

Corporate Headquarters > 400 Godin Avenue, Vanier (Quebec) G1M 2K2 CANADA | Tel.: 1 418 683-0211 | Fax: 1 418 683-2170 | info@exfo.com

Toll-free: 1 800 663.3936 (USA and Canada) | www.exfo.com

EXFO America	4275 Kellway Circle, Suite 122	Addison, TX 75001 USA	Tel.: 1 800 663-3936	Fax: 1 972 836-0164
EXFO Europe	Le Dynasteur, 10/12 rue Andras Beck	92366 Meudon la Forêt Cedex FRANCE	Tel.: +33.1.40.83.85.85	Fax: +33.1.40.83.04.42
EXFO Asia-Pacific	151 Chin Swee Road, #03-29 Manhattan House	SINGAPORE 169876	Tel.: +65 6333 8241	Fax: +65 6333 8242
EXFO China	Beijing New Century Hotel Office Tower, Room 1754-1755 No. 6 Southern Capital Gym Road	Beijing 100044 P. R. CHINA	Tel.: +86 (10) 6849 2738	Fax: +86 (10) 6849 2662

EXFO is certified ISO 9001 and attests to the quality of these products. This device complies with Part 15 of the FCC Rules. Operation is subject to the following two conditions: (1) this device may not cause harmful interference, and (2) this device must accept any interference received, including interference that may cause undesired operation. EXFO has made every effort to ensure that the information contained in this specification sheet is accurate. However, we accept no responsibility for any errors or omissions, and we reserve the right to modify design, characteristics and products at any time without obligation. Units of measurement in this document conform to SI standards and practices. Contact EXFO for prices and availability or to obtain the phone number of your local EXFO distributor. For the most recent version of this spec sheet, please go to the EXFO website at <http://www.exfo.com/specs>. In case of discrepancy, the Web version takes precedence over any printed literature.