



# PMD Issues in Advanced, Very High-Speed Networks

**EXFO**

This pocket guide provides a comprehensive review of polarization mode dispersion (PMD).

PMD has been causing headaches for network operators for more than a decade now, but why is that? What is PMD and will it continue to plague the networks of tomorrow?

This guide explains the fundamentals of PMD as well as all related issues, like polarization, birefringence and DGD. It covers the tolerance specifications of various systems and transmission speeds, the different international standards that must be adhered to and the most common testing techniques used on the market.

The purpose of this guide is to review the PMD phenomenon in detail, its characteristics, its consequences, the nature and effects of its interaction with other critical parameters, its mitigation, along with examples of test results, generalities and limitations.

# Table of Contents

1. Introduction .....	2	5. PMD Specifications and International Standardization ..	26
1.1 The Phenomenon .....	4	5.1 PMD Cable and Link Design Specifications .....	26
1.2 Pulse Broadening, ISI and BER.....	6	5.2 System PMD Specification.....	28
1.3 Higher Bit Rates .....	6	5.3 DGD <sub>max</sub> Specifications for Various Applications and Modulation Formats.....	29
1.3.1 Longer Single-Mode Fibers.....	7	5.4 Proposals for DGD <sub>max</sub> Values for Various Applications and Modulation Formats .....	31
2. Polarization.....	8	5.5 DGD <sub>max</sub> Specifications for Ethernet Applications.....	34
2.1 States of Polarization .....	8	6. PMD-Induced Pulse Broadening and Penalty.....	36
2.1.1 Linear Polarization.....	8	7. PMD Tests and Measurements.....	37
2.1.2 Circular Polarization .....	13	7.1 Description of the Available Test Methods .....	38
2.1.3 Elliptical Polarization.....	15	7.1.1 Fixed Analyzer — Fourier Transform.....	38
2.2 Unpolarized Light .....	16	7.1.2 Interferometric Method [TINTY / GINTY].....	41
3. Birefringence, Causes and Effects.....	17	7.1.2.1 Traditional Analysis .....	42
3.1 Intrinsic Stresses .....	17	7.1.2.2 Generalized Analysis.....	43
3.2 Extrinsic Stresses .....	19	7.1.3 Scrambled State-of-Polarization Analysis .....	44
3.3 Birefringence Planes and Axes.....	20	7.1.3.1 General Theory .....	44
4. Principal States of Polarization.....	21	7.1.3.2 Experimental Implementations .....	45
4.1 Definition .....	21	7.1.3.3 Measurement of PMD as a Function of Distance ....	46
4.2 DGD, PMD and Pulse Broadening.....	21	7.2 Uncertainty in PMD Tests and Measurements .....	47
4.2.1 No Pulse Broadening.....	22	7.3 Calibration of PMD Test and Measurement Instruments .....	47
4.2.2 Fixed DGD, PMD and Pulse Broadening .....	23	7.3.1 Applicability Matrix for the Available PMD Test Methods ....	48
4.2.3 Random DGD, PMD and Growing Pulse Broadening.....	24		
4.2.4 Random DGD, PMD and Growing Pulse Broadening as a Function of Fiber Length.....	25		
4.2.5 Pulse Broadening, ISI and BER .....	24		

## 1. Introduction

The continuous demand for more capacity in telecommunication networks has led to the use of fiber optics. However, this increase in fiber-optic network capacity has led to new limitations, and the principles and understanding of their effects are of interest to the scientific community.

Problems such as attenuation and dispersion are now well-understood. However, at very high bit rates (VHBR), parameters related to polarization, such as polarization mode dispersion (PMD), polarization dependent loss (PDL) and polarization dependent gain (PDG), interact with each other, along with chromatic dispersion (CD) and nonlinear effects (NLE). This interaction brings additional constraints and further considerations. Table 1 summarizes the various issues related to VHBR transmissions.

Table 1 – Issues Related to VHBR Transmissions

Parameter		Issues
Attenuation		Dirty connector
		Excessive bending
Dispersion	CD	Stochastic phenomenon when interacting with PMD
		Residual CD becomes critical
	PMD	Additional constraints when interacting with PDL, PDG, CD and index-related NLEs
		Second-order becomes a major issue
NLE	Self-phase modulation (SPM) and cross-phase modulation (XPM)	Detrimental at high power when interacting with CD and PMD
	Raman optical amplification	Stimulated Raman scattering (SRS) generates double-Rayleigh backscattering (DRBS) and multiple-path interferences (MPI)
	Four-wave mixing (4WM)	Always present in high-power WDM transmissions

Given the shift towards 40 and 100 Gbit/s data rates using new advanced modulation formats, a lot of work has been done on PMD and differential group delay (DGD).

## 1.1 The Phenomenon

It is now accepted that PMD causes an optical pulse to statistically spread and possibly get distorted in the time domain. When the broadening becomes too wide, the stream pulses start to overlap and may produce inter-symbol interference (ISI); the eye pattern starts to close and the bit error rate (BER) increases significantly, which is an indication of serious signal degradation. After a threshold has been reached, the system initiates a communication failure and outage.

The biggest issue with PMD is the fact that it is a stochastic phenomenon (i.e., statistical in nature) and can only be quantified using sampling, distribution and averaging. Similar to any statistical polling, an infinite number of samples would be required to obtain an absolutely accurate result. Since this is impossible, a manageable number of samples must be considered. However, the average value calculated from these samples comes with some level of uncertainty. Since the phenomenon is also subject to time variations, this makes things all the more difficult to understand.

PMD needs a frequency or wavelength to be characterized, like all dispersion. Similar to CD, the basic characterizing parameter is the index of refraction (IOR), which is the index of propagation of the medium in which the signal is transported, such as in an optical fiber. The subsequent variation of this index as a function of frequency or wavelength leads to the group delay as a function of frequency or wavelength.

However, there are two fundamental differences:

- > Polarization of the propagating signal
- > Stochastic behavior, not deterministic

Since the PMD phenomenon is related to polarization, it is therefore related to the propagation axes (i.e., two axes with different indexes of propagation), which leads to birefringence (i.e., difference in the index of refraction). Unlike for CD, there is not just one group delay, but two. A difference in group delays or DGD varies statistically as a function of frequency or wavelength. The DGD variation may follow a regular, smooth function or be totally random.

Whatever the characteristics of the variation, there will be a maximum and a minimum value as well as an average value over the widest possible frequency or wavelength range.

Of course, the phenomenon may change depending on whether it is applied to:

- > a long or short single-mode fiber (SMF)
- > a simple or complex active or passive optical component in a sub-system or in a low- or high-speed network
- > a combination of the above in length, size and quantity

At VHBR, the phenomenon is the same except that the transmitted pulses are closer to each other in the time domain. The effect is that it has faster and more dramatic consequences on statistical broadening. This is why PMD at VHBR is one of the most critical and crucial phenomenon to take into account.

## 1.2 Pulse Broadening, ISI and BER

The impact of pulse broadening due to PMD on network operation is similar to the effect of CD. If the pulse broadens too much, consecutive pulses can overlap in the bit stream and inter-symbol interference (ISI) may occur, increasing BER to the point of causing a service outage. The phenomenon becomes even more detrimental at high bit rates, long SMF lengths and/or with stronger birefringence, especially in the case of legacy SMFs and extrinsic random stresses.

## 1.3 Higher Bit Rates

At lower bit rates, even if the stress is strong and the DGD is large, there may be no PMD effect, such as in Figure 1. However, when the bit rate ( $br$ ) increases, the bit period ( $bp$ ) decreases and the pulses in the bit stream get closer together until they overlap. This leads to ISI and increasing BER until a traffic outage occurs, as shown in Figure 1.

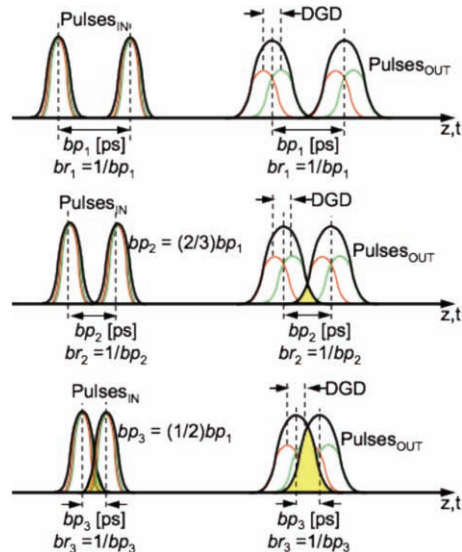

Figure 1 – Effects of Bit Rate Increase (bit period decrease) on ISI



### 1.3.1 Longer Single-Mode Fibers

When the SMF length increases, the probability of cumulative stress and pulse overlap increases, as well as ISI and BER, as shown in Figure 2.

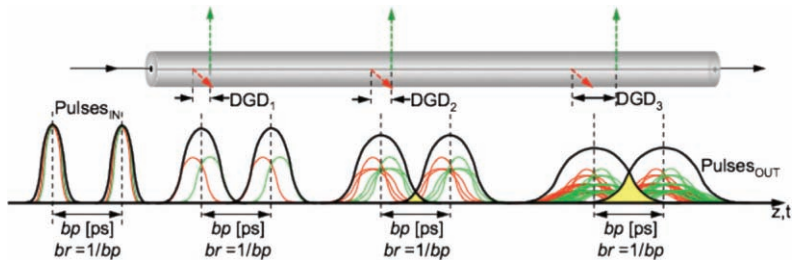

Figure 2 – Effects of SMF Increase (constant bit period) on ISI

## 2. Polarization

The concept of polarization in optics is analogous to the one used in sociology. For instance, in a random group of people arriving at a public meeting, no precise, defined or characteristic behavior is perceived; only background noise from individual conversations. The population is said to be non-polarized or unpolarized; this is the definition of noise. Each individual in the population has his/her own opinion and all the opinions are simultaneously present. However, from an outsider's perspective, the population seems chaotic with no defined opinions or no opinions at all. If a strong, biased speaker gives a presentation, the audience will start showing interest, i.e., the population becomes polarized. This population can be said to be slightly or strongly polarized depending on the percentage of people showing interest. The same is true in optics.

Light, as a transverse electromagnetic wave, is comprised of orthogonal magnetic and electric fields travelling in the same direction called the axis of propagation. Since common electronic detectors/receivers (Rx) respond to the electric field (E-field) effects of electrons in materials, and not the magnetic field effects, only the E-field and its propagation in a glass medium, like an optical fiber, will be considered herein.

### 2.1 States of Polarization

Polarization is a property of light. In fact, the lightwave is said to be polarized when its E-field vector is at a specific angle to the propagating  $z$ ,  $t$  axis. The state of polarization (SOP) is determined by a transmitter (Tx), but defined from the Rx standpoint or from an observer looking at the transmitter or the source of light.

#### 2.1.1 Linear Polarization

The E-field vector may propagate in the  $x - z$ ,  $t$  plane only and the lightwave is then said to be linearly horizontally (LH) polarized. This is because when looking along the  $z$  axis from the Rx to the Tx, the in-coming E-field vector is moving back and forth in the horizontal plane on a straight line. This case is illustrated in Figure 3.

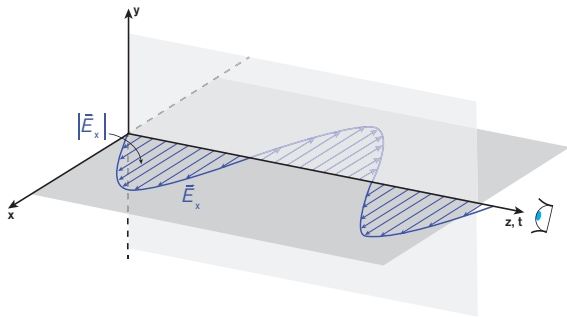

NOTE: The eye represents the direction in which an observer or receiver is looking  
 (a) SOP in  $x - z, t$  plane

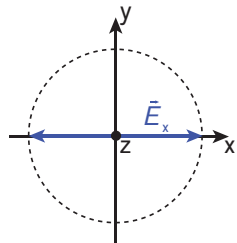

NOTE: The z axis is pointing off the page  
 (b) Propagation in (a) as seen by the observer or receiver

Figure 3 – E-Field Vector Propagation of a Linear Horizontal SOP

The lightwave may also propagate vertically in the  $y - z, t$  plane and is then said to be linearly vertically (LV) polarized. This case is illustrated in Figure 4.

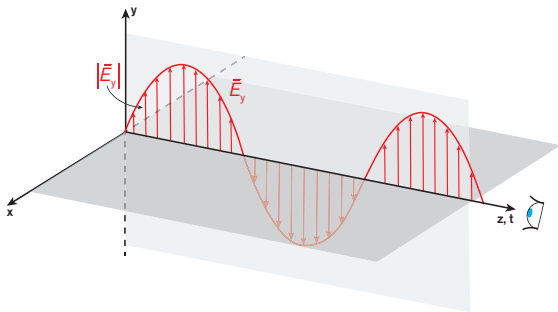

NOTE: The eye represents the direction in which an observer or receiver is looking

(a) SOP in  $y - z, t$  plane

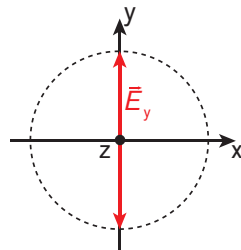

NOTE: The  $z$  axis is pointing off the page

(b) Propagation in (a) as seen by the observer or receiver

Figure 4 – E-Field Vector Propagation of a Linear Vertical SOP

The wave can also be defined as the combination of an  $x - z, t$  plane wave and a  $y - z, t$  plane wave, such as the ones shown in Figure 5. The resulting wave propagates at a certain angle such as  $+\pi/4$  ( $+45^\circ$ ) or  $-\pi/4$  ( $-45^\circ$ ) or any other angle as shown in Figure 5.

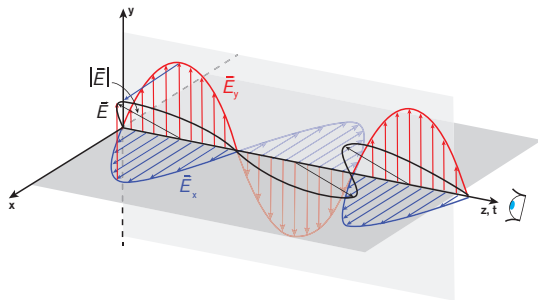

NOTE: The eye represents the direction in which an observer or receiver is looking

(a)  $-\pi/4$  ( $-45^\circ$ ) SOP from both linear orthogonal SOPs in the  $y - z, t$  and  $x - z, t$  planes

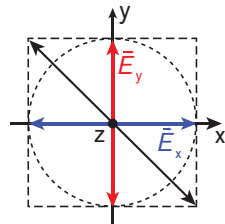

NOTE: The  $z$  axis is pointing off the page

(b) Propagation in (a) as seen by the observer or receiver

Figure 5 – Angular E-Field Vector Propagation of a Linear  $+45^\circ$  SOP

Depending on the relative amplitude of both E-field vectors, the resulting E-field vector will have a proportional polarization angle as shown in Figure 6.

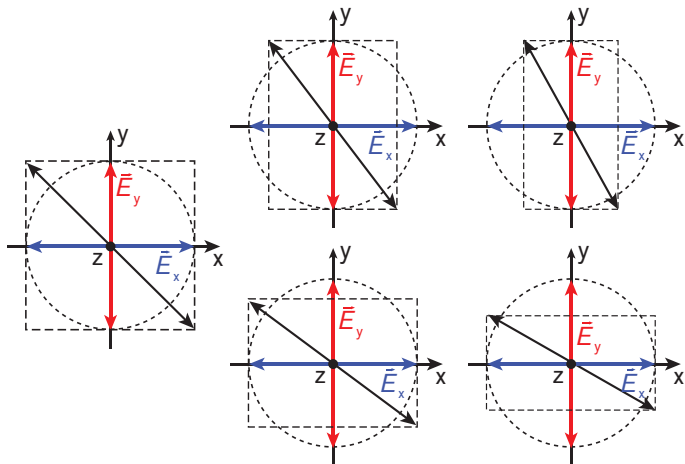

NOTE: The z axis is pointing off the page

Figure 6 – Linear Angular E-Field Vector Propagation with Different Amplitudes and Angles

## 2.1.2 Circular Polarization

When one orthogonal wave propagates out of phase by  $+\pi/2$  ( $+90^\circ$ ) from the other, the resulting wave is said to be circularly polarized. The direction of rotation of this circular polarization, either clockwise or counterclockwise, depends on the sign of the relative phase shift between the two waves ( $x - z, t$  wave and  $y - z, t$  wave). The resulting wave is clockwise circularly polarized when the relative phase shift is  $+\pi/2$  ( $+90^\circ$ ). In this case, the  $x - z$  plane wave lags behind the  $y - z$  plane wave by  $+\pi/2$  ( $+90^\circ$ ) as shown in Figure 7. The polarization is also said to be circular left-hand (Clh).

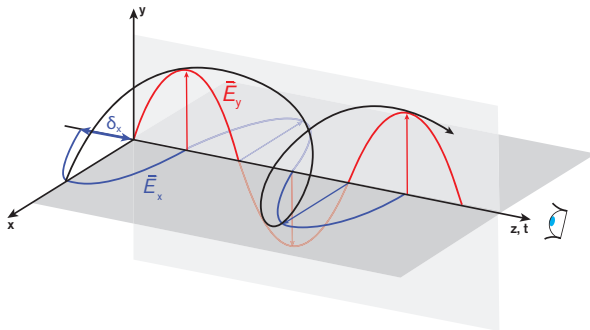

NOTE: The eye represents the direction in which an observer or receiver is looking

(a) -SOP in both  $y - z, t$  and  $x - z, t$  planes

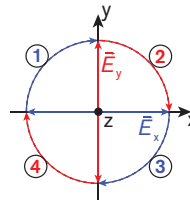

NOTE: The z axis is pointing off the page

(b) Clockwise rotation of the wave vector from (a) as seen by the observer or receiver

Figure 7 – Clockwise Rotation of the Wave Vector

The resulting wave may also propagate counterclockwise when the relative phase shift is  $-\pi/2$  ( $-90^\circ$ );  $x - z$  plane wave lagging behind the  $y - z$  plane wave by  $+\pi/2$  or  $+90^\circ$ . In this case, the resulting polarization is said to be circular right-hand (Crh) as shown in Figure 8.

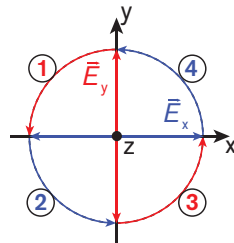
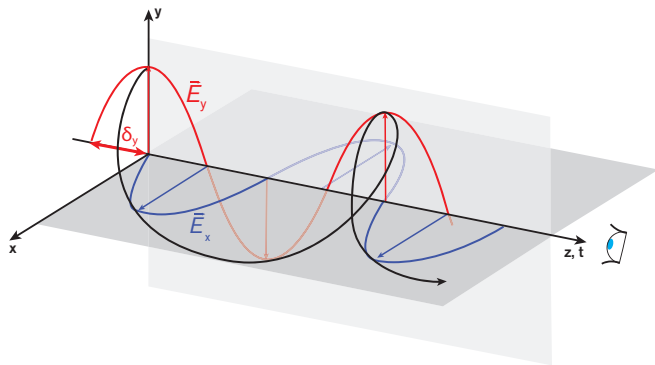

NOTE: The eye represents the direction in which an observer or receiver is looking

(a) SOP of circular right-handed polarized wave

NOTE: The z axis is pointing off the page

(b) Counterclockwise rotation of the wave vector from (a) as seen by the observer or receiver

Figure 8 – E-Field Vector Propagation of Circular Right-Hand SOP



### 2.1.3 Elliptical Polarization

In the more general case of an arbitrary, non-zero relative phase shift between the x - z plane wave and the y - z plane wave, the resulting wave will be elliptically polarized. A general representation in the x - y plane of a polarized wave as seen by the observer or the receiver is shown in Figure 9.

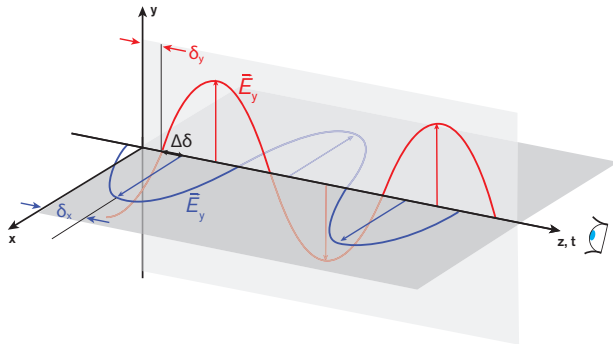

NOTE: The eye represents the direction in which an observer or receiver is looking

(a) SOP of an elliptically polarized wave

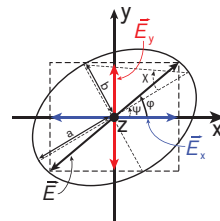

NOTE: The z axis is pointing off the page

(b) Elliptical rotation of the wave vector from (a) as seen by the observer or receiver

Figure 9 – E-Field Vector Propagation of an Elliptical SOP

Of course, depending on the amplitude relationship of the E-field vectors in the x - z, t plane and the y - z, t plane and their respective phase relationship, an infinite amount of elliptical polarizations can be observed.

## 2.2 Unpolarized Light

When the E-field vector is propagating in any random orientation around the z, t axis, at any point along the z axis and/or at any point in time, this wave is said to be unpolarized; much like the previous audience analogy (refer to page 8 – Polarization). This is shown in Figure 10.

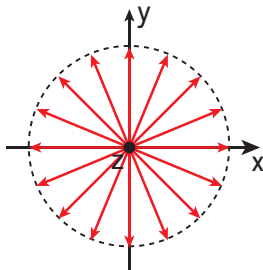

*NOTE: The z axis is pointing off the page*

*Figure 10 – Propagation of the E-Field Vector of an Unpolarized Wave*

### 3. Birefringence, Causes and Effects

Birefringence means two (bi) refraction indexes (refrignence). This is caused in optical fibers by imperfections and perturbations in the fiber core, thus creating a polarization dependence in the fiber's index of refraction (IOR). These imperfections or perturbations may be random or imposed intrinsic stresses or random extrinsic stresses. Intrinsic and extrinsic sources of stress produce birefringence in the fiber core.

#### 3.1 Intrinsic Stresses

Intrinsic stresses are produced during the design and manufacture of preform, fiber and cabled fiber. Examples of these sources are shown in Figure 11. Random intrinsic stresses create a fiber-baseline birefringence, which is always present, relatively weak and to some extent, controllable (manageable). Imposed intrinsic stresses create a relatively strong birefringence. Examples are shown in Figure 12.

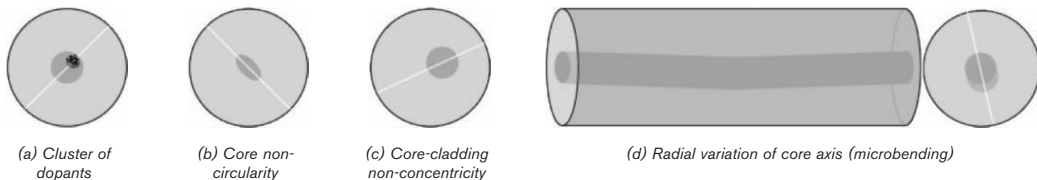
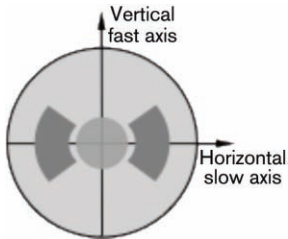
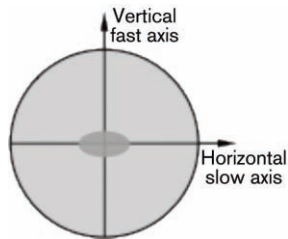

Figure 11 – Examples of Random Intrinsic Stresses on the Fiber Core



(a) Polarization-maintaining fiber



(b) High-birefringence (Hi-Bi) fiber

Figure 12 – Examples of Imposed Systematic Intrinsic Stress Causing Linear Fiber Birefringence

Twisting the fiber, as shown in Figure 13, is not going to produce any axial stress and consequently, no PMD.

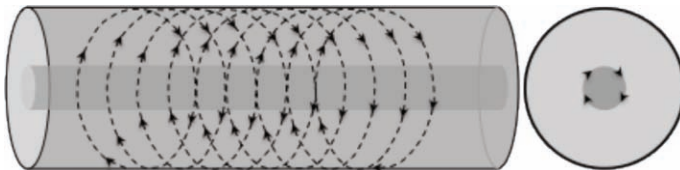

Figure 13 – Examples of Extrinsic Stress (twisting-torsion) Causing Circular Fiber Birefringence

## 3.2 Extrinsic Stresses

Extrinsic stresses are produced during cable installation and by the environment during network operation. Since they are random in nature and difficult to mitigate, these extrinsic stresses are the worst contributors to PMD in installed, cabled fibers. The magnitude of the birefringence will depend on the nature and conditions of these stresses.

It is important to note that PMD in the field is directly proportional to the extrinsic stress and to the length of the installed cabled-fiber sections, spans and links. The terms are defined as follows:

- > An installed cabled-fiber section is the distance between two splices
- > A span is the distance between two optical inline amplifiers
- > A link is the distance between Tx and Rx

A local, stressful event produced over a short distance (meters), such as the pinching, bending and twisting of a fiber in a manhole or removing the fiber from a trench, is unlikely to contribute significantly to the randomly accumulated stresses over a long distance (kilometers). This will barely or not at all increase the overall PMD.

### 3.3 Birefringence Planes and Axes

As seen on the previous page, birefringent materials will exhibit two different indexes in two different planes that are perpendicular to the axis of propagation (z plane). These planes (of polarization) will not have equal IORs. The larger IOR will create a slower phase velocity along that plane. This axis does not have to be the x or y axis as shown in Figure 14; it depends on the direction of perturbation (stress).

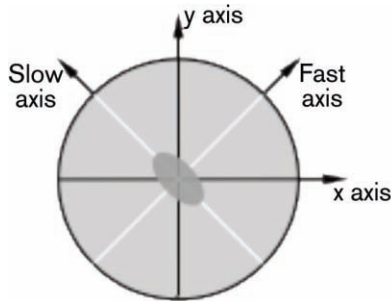

Figure 14 – Difference Between x, y Axes and Fast, Slow Axes

The wave propagating in the plane of perturbation with the lowest phase velocity is said to be retarded with respect to the other wave and its polarization axis is called the slow axis; the fast axis corresponds to a smaller IOR and a faster phase velocity. This retardance is due to birefringence.

## 4. Principal States of Polarization

This chapter will examine one of the most critical parameters responsible for PMD: the principal states of polarization.

### 4.1 Definition

In a birefringent medium, such as an optical fiber, there are two states of polarization (SOP) called the principal SOPs (PSP).

One PSP is called the slow PSP. It is aligned with the slow axis (higher IOR or propagation index) and yields the slowest group velocity and consequently, the longest propagation delay. The other one is called the fast PSP. It gives the fastest group velocity and consequently, the shortest propagation delay.

These two PSPs are typically orthogonal.

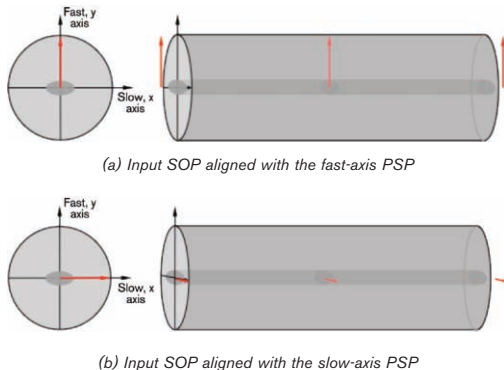

Figure 15 – Unchanged Output SOP for Input SOP Aligned with PSP

### 4.2 DGD, PMD and Pulse Broadening

Pulse broadening is related to the PSP split and how the pulse SOP is launched with respect to the PSP axes. The PSP split in the time domain is related to the PSP difference in group velocity and difference in their group delay or DGD.

## 4.2.1 No Pulse Broadening

Figure 16 shows that if a pulse's SOP is aligned with a PSP axis, the pulse travels from the input to the output undisturbed. For example, a racecar that is travelling along on a perfect racetrack will travel without interference.

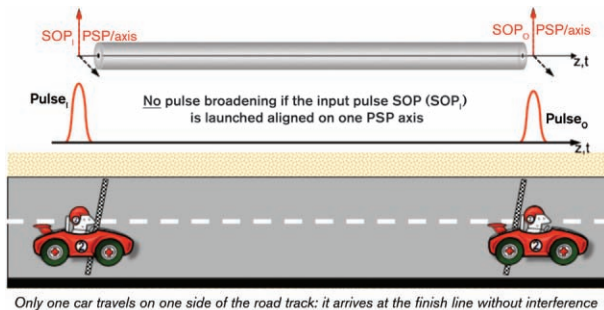

Figure 16 – Pulse Whose SOP is Aligned with a PSP Experiences No DGD and No Pulse Broadening



## 4.2.2 Fixed DGD, PMD and Pulse Broadening

Figure 17 shows an input pulse SOP launched with its energy shared half-half by two PSP's. If this pulse is launched in a Polarization Maintaining Fiber (PMF), the pulse travels from the input to the output disturbed by the fixed stress imposed by the PMF design. For example, a racecar is driving on one lane of the racetrack with rough pavement along its edge, while another car is racing on another lane with no disturbances. There is therefore a large fixed stress and one car lags behind the other by a fixed, constant delay, until the end of the race. This example illustrates the following conditions:

- > PMF case
- > Systematic constant stress applied to one PSP axis/plane
- > Launch SOP aligned equally between both PSPs (equal PSP energy in the pulse)
- > PMD value (mean or RMS DGD) depending on the length.

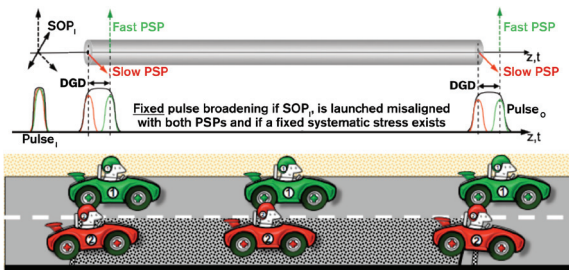

Two cars start at the same time, but one experiences a systematic fixed disturbance and gets retarded by a constant delay with respect to the other one until the finish line

Figure 17 – Pulse Whose SOP is Aligned with Both PSPs Experiences Fixed DGD and Pulse Broadening

In the above example, the stress (birefringence) is constant over the full length of the SMF.

### 4.2.3 Random DGD, PMD and Growing Pulse Broadening

In Figure 18, the stress (birefringence) varies randomly in magnitude and length over the full distance of the fiber. The input pulse SOP is launched with a certain amount of energy shared over both PSPs. As a consequence, the pulse experiences a continuous broadening caused by that random stress from input to output. For example, two racecars are travelling along a racetrack and both are experiencing bumps varying in size and length over the full distance of the racetrack. At constant velocity, each car suffers a delay that is comparable to the other car and the statistical accumulation of these delays will determine the overall delay at the finish line. This example illustrates the following conditions:

- > Conventional telecom fiber case
- > Random, variable stress applied to both PSP axes/planes
- > Launched SOP shared between both PSPs
- > PMD value (mean or RMS DGD) depending on the SMF length, magnitude of individual stress and degree of randomness (ideal or semi-random)

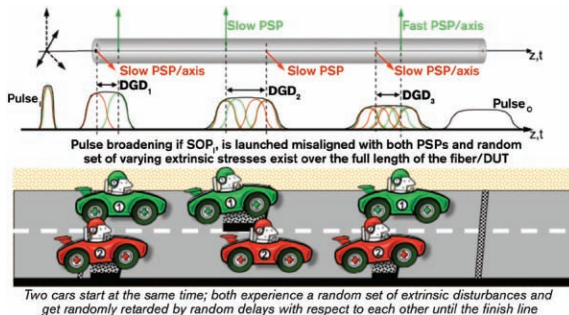

Figure 18 – SMF Case with Random Coupling, DGD and Growing Pulse Broadening

#### 4.2.4 Random DGD, PMD and Growing Pulse Broadening as a Function of Fiber Length

In Figure 18, the pulse broadens along the entire SMF length. Figure 19 illustrates this property for various SMF lengths.

According to Figure 19, a short-length PMD case is established on the basis of a cable section ( $\leq 6$  km) especially considering the constant manufacturing improvement in lowering PMD in SMFs. The case does not apply to patchcords, jumpers or any short cable assemblies.

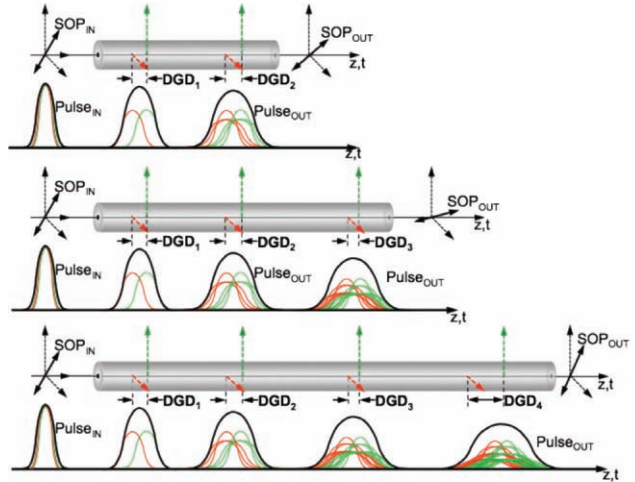

Figure 19 – Growing Pulse Broadening with SMF Length

## 5. PMD Specifications and International Standardization

With the advent of 40 and 100 Gbit/s using new advanced modulation formats, a number of publications on PMD and DGD specifications have been written by IEEE 802.3, the ITU-T and its Study Group 15, as well as the IEC Technical Committee – TC 86.

### 5.1 PMD Cable and Link Design Specifications

A PMD link design value,  $PMD_Q$ , is used as a PMD coefficient (PMD per unit of distance) for cables/links. The  $PMD_Q$  (coefficient) is used as an upper limit for the PMD coefficient of a long optical cabled SMF within a defined concatenated link of  $M$  cable sections. This limit is defined in terms of a probability level,  $Q$ , which is the probability that the PMD coefficient value of that long cabled SMF exceeds the  $PMD_Q$  (coefficient). For the values of  $M$  and  $Q$  given in Table 2 (see page 27), the corresponding values of  $PMD_Q$  (coefficient) are not to be exceeded.

Table 2 — Recommended [standardized] Values of the Maximum PMD Coefficient

Number of cable sections M	Probability level Q	SMF			PMD <sub>0</sub> (coefficient) [ps/km <sup>1/2</sup> ]
		ITU-T		IEC	
		Type	Category	60793-2-50	
20	1 x 10 <sup>-4</sup> or 0.01%	G.652	A and C <sup>1</sup>	B1.1	≤ 0.5
			B and D <sup>1</sup>	B1.3	≤ 0.20
		G.653	A	B2	≤ 0.5
			B		≤ 0.20 (Larger values can be agreed upon by manufacturers and users)
		G.654	A	B1.2	≤ 0.5
			B and C		≤ 0.20
		G.655	A and B	B4	≤ 0.5
			C, D and E		≤ 0.20
		G.656		B5	≤ 0.20
		G.657	A	B6	≤ 0.20
B	Not essential as the SMF supports the access network installation with very small bending radii				

<sup>1</sup> G.652.C and G.652.D SMFs are also called low water-peak SMFs

It is important to remember that the PMD<sub>Q</sub> specification can only be used for cabled SMFs in production, and installed links, spans and cable sections, with careful consideration for PMD measurement uncertainties, as discussed below.

## 5.2 System PMD Specification

The maximum DGD ( $DGD_{max}$ ) is used as a PMD specification in transmission systems.  $DGD_{max}$  is defined as a DGD value corresponding to the probability that the transmission system will experience a DGD value larger than  $DGD_{mean}$  over a duration specified in Table 3.

Due to the statistical nature of PMD, a relationship between  $DGD_{max}$  and  $DGD_{mean}$  can be established and defined probabilistically using a ratio  $S$  of  $DGD_{max}$  to  $DGD_{mean}$ , as shown in Table 3.

International standards organizations provide documents on  $DGD_{max}$  specifications for various applications and bit rates (br). The following sections provide a summary of  $DGD_{max}$  specifications with a 1-dB penalty, except otherwise indicated.

While most test equipment measure  $DGD_{mean}$  (or  $DGD_{rms}$ ), systems use  $DGD_{max}$ . Table 3 helps translate a system requirement into a testing requirement, based on an acceptable BER.

Table 3 – Ratio of Maximum to Mean DGD and Corresponding Probability

DGD <sub>max</sub> to DGD <sub>mean</sub> Ratio	Probability of DGD <sub>mean</sub> being over DGD <sub>max</sub>	Time per year of DGD <sub>mean</sub> being over DGD <sub>max</sub>
2.5	$1.5 \times 10^{-3}$	13.1 h
3.0	$4.2 \times 10^{-5}$	22 min
3.1	$2.0 \times 10^{-5}$	10.5 min
3.2	$9.2 \times 10^{-6}$	5 min
3.25	$6.19 \times 10^{-6}$	3.2 min
3.3	$4.1 \times 10^{-6}$	2.15 min
3.4	$1.8 \times 10^{-6}$	56.6 s
3.5	$7.7 \times 10^{-7}$	24 s
3.6	$3.2 \times 10^{-7}$	10.1 s
3.7	$1.3 \times 10^{-7}$	4.1 s
3.75	$8.21 \times 10^{-8}$	2.6 s
3.775	$6.5 \times 10^{-8}$	2.0 s
3.8	$5.1 \times 10^{-8}$	1.6 s
3.9	$2.0 \times 10^{-8}$	0.63 s
4.0	$7.4 \times 10^{-9}$	0.23 s
4.1	$2.7 \times 10^{-9}$	0.09 s
4.2	$9.6 \times 10^{-10}$	0.03 s
4.3	$3.3 \times 10^{-10}$	0.01 s
4.4	$1.1 \times 10^{-10}$	0.0035 s
4.5	$3.7 \times 10^{-11}$	0.0012 s
4.6	$1.2 \times 10^{-11}$	0.00038 s

### 5.3 DGD<sub>max</sub> Specifications for Various Applications and Modulation Formats

DGD<sub>max</sub> specifications are listed in Tables 4.a and b for synchronous digital hierarchy (SDH)/synchronous optical network (SONET) non-return to zero (NRZ) and optical transport network (OTN) applications. It is assumed that at bit rates lower than those in the table, DGD<sub>max</sub> becomes too large to have a significant effect on power penalty due to PMD.

Table 4.a – DGD<sub>max</sub> Specifications for SDH/SONET NRZ Applications

NRZ applications		Bit rate [Gbit/s]		DGD <sub>max</sub> [ps]
STM-x	OC-x	Exact	Nominal	
4	12	0.622	0.622	480
8	24	1.244	1.25	240
16	48	2.488	2.5	120
64	192	9.953	10	30
256	768	39.813	40	7.5  (some SMF categories have a PMD coefficient too high to guarantee this DGD)

Table 4.b – DGD<sub>max</sub> Specifications for OTN Applications

OTN applications	Bit rate [Gbit/s]	DGD <sub>max</sub> [ps]
NRZ OTU1 + FEC	2.666	120
NRZ OTU2 + FEC	10.709	30
NRZ OTU3 + FEC	43.018	7.5  (some SMF categories have a PMD coefficient too high to guarantee this DGD)

NOTE: OTU: optical transport unit; FEC: forward error correction

Table 4.c – DGD<sub>max</sub> Specifications for NRZ 25G (OTN NRZ OTL4.4) Application

Parameters	Units	OTN NRZ OTL4.4 <sup>1</sup> + FEC	
Nominal bit rate	Gbit/s	25	
OTN bit rate		4 x 27.953 [111.810]	
Wavelength window	nm	1310	
Frequency range	THz	229.0 + (0.8•m), m = 0 to 3	
Source type	–	SLM	
Channel spacing	GHz	800	
Number of channels	–	4	
SMF type		ITU-T Rec. G.652 [??]	
Maximum BER		1x10 <sup>-12</sup>	
Maximum path penalty	dB	1.5	2.5
Maximum attenuation	dB	6.3	18
Reach	km	10	40
DGD <sub>max</sub>	ps	8	10.3

<sup>1</sup> Optical channel transport lane (OTL) 4.4 (OTU4 signal running on 4 channels also called lanes) =  $255/227 \times 24.883200 \text{ Gbit/s} = 27.952493 \text{ Gbit/s per lane or } 111.810 \text{ Gbit/s total}$



## 5.4 Proposals for $DGD_{max}$ Values for Various Applications and Modulation Formats

Tables 5 and 6 list the various proposals for system PMD specifications at 40 and 100 Gbit/s respectively. The  $DGD_{max}$  values should not be interpreted or used as system PMD specifications. The information is given only to demonstrate the effort of the international standardization community to understand the effect of PMD at very high bit rates and in various transport mechanisms. This continuous and evolving effort may eventually lead to system PMD specifications.

Table 5.a — Proposed  $DGD_{max}$  Values for 40-Gbit/s OTN Applications Using Various Modulation Formats

OTN application		40G OTU3 + FEC				
Parameters	Units	ODB/PSBT	NRZ-DPSK	NRZ-p-DPSK 66 GHz FSR	P-DPSK	DP-QPSK [coherent]
Bit rate	Gbit/s	43.018				4 x 10.7545
Wavelength range	nm	1530 - 1565 [C-band]				
SMF type reference	—	ITU-T Rec. G.652 [77] and G.655 [80]				
$DGD_{max}$ (1-dB OSNR penalty)	ps	5.5/7	8	7	6	75

ODB: optical duo binary; PSBT: phase-shaped binary transmission; DPSK: differential phase-shift keying; FSR: free spectral range; DP-QPSK: dual polarization-quadrature phase-shift keying

Table 5.b – Proposed  $DGD_{max}$  Values for 40-Gbit/s OTN Applications Using Various –RZ-Based Modulation Formats (return to zero)

OTN application		40G OTU3+ FEC			
Parameters	Units	RZ-QPSK	RZ-DQPSK (coherent)	OPFDM-RZ-DQPSK	RZ-AMI
Bit rate	Gbit/s	43.018	2 x 21.509	2 x 21.509	43.018
Wavelength range	nm	1530 - 1565			
SMF type reference	–	ITU-T Rec. G.652 [??] and G.655 [80]			
$DGD_{max}$ (1-dB OSNR penalty)	ps	9	18/20	20	9.5

*DQPSK: Differential QPSK; OPFDM: orthogonal polarization frequency-domain multiplexing; AMI: alternate mark inversion*

Table 6.a – Proposed  $DGD_{max}$  Values for 100-Gbit/s OTN Applications Using Various Modulation Formats

OTN application		100G OTU4				
Parameters	Units	NRZ		ODB/PSBT		
Bit rate	Gbit/s	4 x 27.953 (111.810)	3 x 43.018 (130)	43.018	4 x 27.953 (111.810)	3 x 43.018 (130)
Wavelength range	nm	1530-1565 (not mentioned but presumed)				
SMF type reference	–	ITU-T Rec. G.652 [??] and G.655 [80]				
$DGD_{max}$ (1-dB OSNR penalty, BER = $1 \times 10^{-4}$ )	ps	2.9	2.5	7	2.7	2.3

Table 6.b – Proposed  $DGD_{max}$  Values for 100-Gbit/s OTN Applications Using Various Modulation Formats

OTN application		100G OTU4				
Parameters	Units	RZ-QPSK			DPSK	
Bit rate	Gbit/s	43.018	4 x 27.953 [111.810]	3 x 43.018 [130]	4 x 27.953 [111.810]	3 x 43.018 [130]
Wavelength range	nm	1530-1565 (not mentioned but presumed)				
SMF type reference	–	ITU-T Rec. G.652 [??] and G.655 [80]			ITU-T Rec. G.652 [??] + DCF (80 km + 12.8 km)	
$DGD_{max}$ (1-dB OSNR penalty, BER = $1 \times 10^{-4}$ )	ps	19	7.3	6.3	9	7.7
		Ratio DGD to symbol duration = 10%				

DCF: dispersion-compensating fiber

 Table 6.c – Proposed  $DGD_{max}$  Values for 100-Gbit/s OTN Applications Using the Most Advanced Modulation Formats

OTN application		100G OTU4					
Parameters	Units	DP-QPSK		QPSK		DP-QPSK	
Bit rate	Gbit/s	4 x 27.953 [111.810]	3 x 43.018 [130]	4 x 27.953 [111.810]	3 x 43.018 [130]	4 x 27.953 [111.810]	3 x 43.018 [130]
Wavelength range	nm	1530-1565 (not mentioned but presumed)					
SMF type reference	–	ITU-T Rec. G.652 [??] + DCF (80 km + 12.8 km)					
$DGD_{max}$ (1-dB OSNR penalty, BER = $1 \times 10^{-4}$ )	ps	27	23	18	15.4	36	30.8
		Ratio DGD to symbol duration = 10%					

## 5.5 DGD<sub>max</sub> Specifications for Ethernet Applications

The tables below show the Ethernet system PMD specifications for various bit rates.

Table 7.a — DGD<sub>max</sub> Specifications for 40-Gbit/s Ethernet Serial Application [95]

OTN application		40GBASE-FR	
Parameters	Units		
Signaling rate	Gbit/s	41.25	
Channel spacing	nm	—	
Wavelength range	Tx	1530 to 1565	
	Rx		1290 to 1330 1530 to 1565
SMF type	—	IEC 60793-2-50 type B1.1, B1.3, B6 [96]	
Reach	km	0.002 to 2	
DGD <sub>max</sub> [2-dB penalty, BER = 1 x 10 <sup>-12</sup> ]	ps	0.5	

Table 7.b – DGD<sub>max</sub> Specifications for 40-Gbit/s and 100-Gbit/s Ethernet Applications [97]

OTN application				
Parameters	Units			
Signaling rate	Gbit/s	4 lanes x 10.3125 GBd (41.25 Gbit/s)	4 lanes x 25.78125 GBd (103.125 Gbit/s)	
Channel spacing	nm	20 (CWDM)		
	GHz		800 (DWDM)	
Center wavelength (wavelength range)	nm	1271 nm (1264.5 to 1277.5) 1291 nm (1284.5 to 1297.5) 1310 nm (1304.5 to 1317.5) 1331 nm (1324.5 to 1337.5)		
Center frequency (wavelength range)	THz		231.4 THz (1294.53 to 1296.59) 230.6 THz (1299.02 to 1301.09) 229.8 THz (1303.54 to 1305.63) 229.0 THz (1308.09 to 1310.19)	
SMF type	—	IEC 60793-2-50 type B1.1, B1.3 , B6		
Reach	km	0.002 to 10	0.002 to 10	0.002 to 30
				0.002 to 401
DGD <sub>max</sub> (2.6-dB link penalty, BER = 1 x 10 <sup>-12</sup> )	ps	10	8	10.3

<sup>1</sup> Links > 30 km with the same power budget are considered engineered links. Attenuation for such links needs to be less than the worst case specified for B1.1, B1.3 or B6A SMF

## 6. PMD-Induced Pulse Broadening and Penalty

$DGD_{max}$  is set to allow no more than a specified power penalty. The worst case power penalty is also affected by the transmission format: NRZ or RZ.

For 40-Gbit/s NRZ applications, a 1-dB penalty allowance corresponds to a  $DGD_{max}$  of 7.5 ps, which is the limit on the DGD at the receiver. If half the penalty is allowed, then the  $DGD_{max}$  decreases, whereas if twice as much penalty is allowed, then the  $DGD_{max}$  increases, giving the system more PMD tolerance.

Figure 20 shows the mean PMD-induced power penalty as a function of PMD.

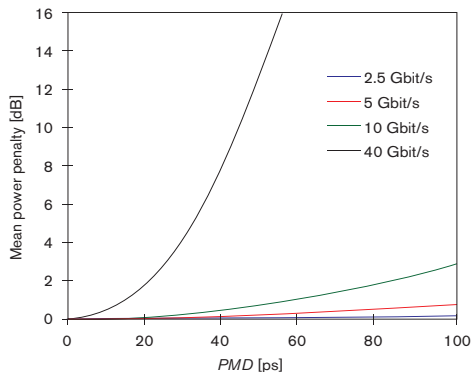

Figure 20 – PMD-Induced Mean Power Penalty as a Function of PMD and Bit Rate

## 7. PMD Tests and Measurements

PMD measurement has been the subject of studies and publications including lengthy discussions in international forums since the early 90s, when operators began to observe the impact of PMD at 10 Gbit/s as random network outages.

Since then, quite a few PMD measurement and test methods have been proposed. The following is a list containing the main ones, in alphabetical order:

- > Fixed analyzer
  - Extrema counting (FA-EC) (standardized; N/A)
  - Fourier transform (FA-FT) (standardized; commercially available)
- > Interferometric method:
  - Generalized interferometry (GINTY) (standardized; commercially available)
  - Traditional interferometry (TINTY) (standardized; commercially available)
- > Modulation phase shift (MPS) (standardized; N/A)
- > Poincaré sphere arc method (PS) also called SOP method (standardized; N/A)
- > Polarization phase shift (PPS) (standardized; N/A)
- > Scrambling SOP analysis (SSA) (standardized; commercially available)
- > Stokes parameter evaluation:
  - Jones matrix eigenanalysis (JME) (standardized; commercially available)
  - Poincaré sphere analysis (PSA) (standardized; N/A)

*NOTE: N/A means that the method is either only published or not commercially available.*

Only the methods that are available and usable in field instruments for installed-link PMD testing are discussed hereafter.

## 7.1 Description of the Available Test Methods

### 7.1.1 Fixed Analyzer — Fourier Transform

FA-FT uses one SOP from a BroadBand Source (BBS) or a Tunable Laser Source (TLS) and one SOP from a corresponding optical spectrum analyzer or power meter depending on the setup, as shown in Figure 21.

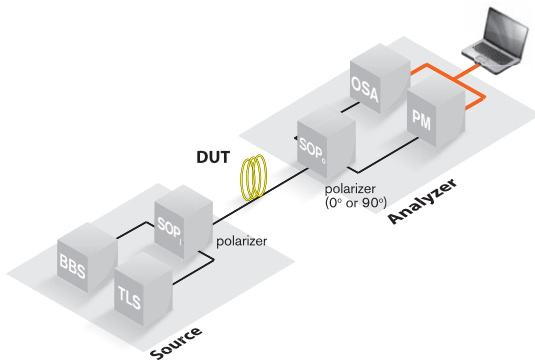

Figure 21 — Schematic of FA-FT Test Method Setup

The method measures the statistical power variation of the SOP going across and changed by a DUT during a wavelength scan (this is where the term wavelength scanning originated).



Similar to TINTY, which will be discussed below, FA-FT must respect stringent requirements (these stringent requirements will not be repeated in the TINTY section to lighten the text):

- > If a BBS is used, its spectrum must be Gaussian with no spectral power ripples
- > The mode coupling must be random (no mixed coupling measurements are allowed); Figure 22 illustrates Random Mode Coupling (RMC)

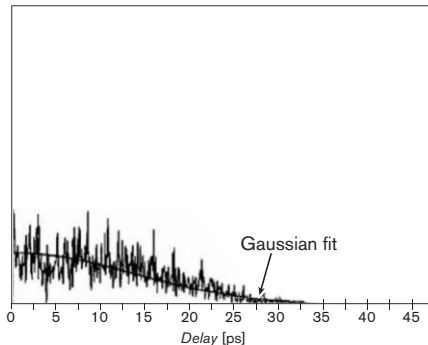

Figure 22 – Schematic of FA-FT Test Method Setup

- > The SMF must be very long (kms)
- > The resulting interferogram (half) must be ideally Gaussian (half) with a large number of fringes (100s to 1000s)
- > The resulting interferogram (half) must extend to zero by at least three times its RMS half-width
- > The PMD must be large (no fraction-of-a-ps measurement is allowed); no cable section measurements are allowed
- > No measurements of optical amplifiers or narrowband components or links containing them are allowed with the BBS
- > The TLS Degree of Polarization (DOP) must remain high during the measurement period
- > The frequency increment/spacing must be constant
- > The source spectrum (BBS) or range (TLS) is limited to a predefined fixed window, so the statistical averaging is limited to a finite amount of wavelengths (or window) and consequently, the mean or RMS value comes with an uncertainty that is directly proportional to the spectral windowing.

In the case of random mode coupling (RMC), like any other PMD test method, the light source window must be as wide as possible (e.g., typically  $\geq 200$  nm, theoretically to infinity) in order to get the largest possible amount of statistical sampling. This allows the statistical average to be determined with a minimum amount of uncertainty. This is why it is difficult to obtain an accurate PMD value with short SMF and low PMD: the uncertainty simply becomes unacceptably high.

## 7.1.2 Interferometric Methods (TINTY/GINTY)

The interferometric PMD test method is divided into two different analyses:

- > A traditional analysis restricted to a number of stringent conditions for getting  $DGD_{RMS}$  in RMC regime (large PMD value, long SMF) as defined in the previous section
- > An unrestricted, generalized analysis for getting  $DGD_{RMS}$  in any mode coupling regime (any SMF type and length and any PMD value).

### 7.1.2.1 Traditional Analysis

The traditional interferometric PMD test method, TINTY, is based on a linearly polarized BBS and an interferometer (in which orthogonal SOPs interfere) as well as a polarizing analyzer that is used at the input, as shown in Figure 23.

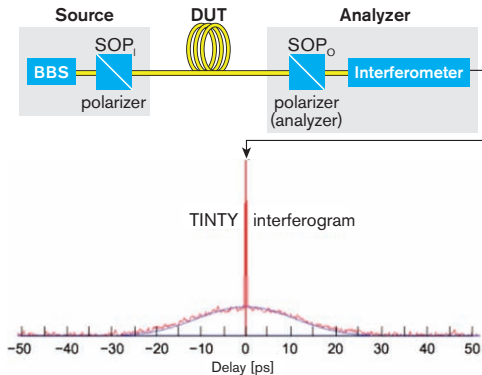

Figure 23 – TINTY Schematic and Typical Test Result Interferogram

### 7.1.2.2 Generalized Analysis

In case of GINTY, there are no restrictive conditions and the method applies to any situation starting at the lowest PMD (zero) of a very complex DUT or link with mixed mode coupling or to any light source shape and spectrum.

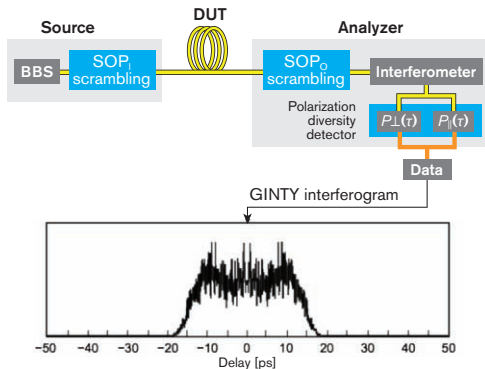

Figure 24 – GINTY Schematic and Typical Cross-Correlation Interferogram Test Result

## 7.1.3 Scrambled State-of-Polarization Analysis (SSA)

### 7.1.3.1 General Theory

SSA measures the power from the DUT at two closely spaced frequencies (i.e., a frequency pair) with  $k = 1$  to  $N$ , where  $N$  is the total number of pairs across a selected frequency range. Every pair is associated to a set of randomly and uniformly scrambled in/out-SOPs in order to obtain the DGD or one randomly scrambled in/out-SOP to obtain the PMD.

Figure 25 illustrates the concept of frequency pairs, the amount of center frequencies, frequency spacing and frequency ranges in an SSA implementation.

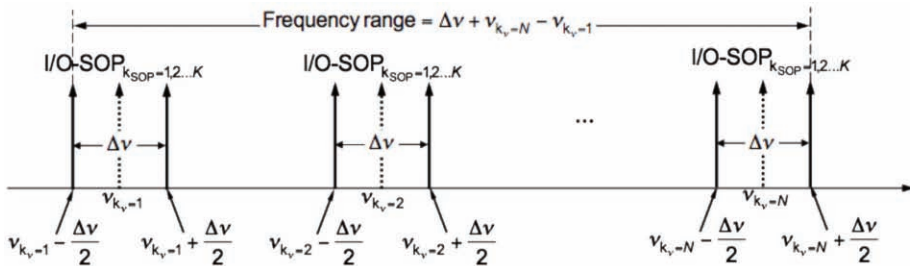

NOTE: I/O-SOP's are randomly and uniformly scrambled at every pair

Figure 25 – SSA Concepts of Frequency Pair, Spacing and Range and I/O-SOP Scrambling

From a measurement standpoint, a large number of I/O-SOPs (in the thousands) improves the uncertainty, but it requires a long measurement and averaging time. On the other hand, a small number of I/O-SOPs (in the tens) requires a shorter measurement and averaging time, but has increased uncertainty.

### 7.1.3.2 Experimental Implementations

With the above approach, SSA can be used in an end-to-end forward implementation or in a single-end roundtrip implementation. Each implementation has its own experimental configuration and application conditions. Table 8 describes the various SSA implementations, conditions and results.

Table 8 – SSA Experimental Configuration Matrix Using TLS

Parameters	SSA implementation	
	End-to-end forward	Single-end roundtrip
SOP	Independent randomly and uniformly scrambled I-SOP and O-SOP	Combined randomly and uniformly scrambled I/O-SOP
Light source	CW TLS	Pulsed TLS
Detection	Polarization diversity detector	

### 7.1.3.3 Measurement of PMD as a Function of Distance

Another SSA implementation is the quantitative measurement of PMD ( $DGD_{RMS}$ ) as a function of distance along an installed, cabled SMF using random scrambling polarization optical time domain reflectometry (RS-POTDR).

Since the implementation is based on OTDR, the single-end roundtrip configuration is used, as shown in Figure 26.

The same SSA theory applies here, except that in this case, the average is calculated as a function of distance using a certain distance interval from the installed SMF related to the selected OTDR pulse width.

The  $PMD(z)$  value is calculated from the value of local differences between pairs of OTDR traces, which correspond to random pairs of closely-spaced frequencies/wavelengths.

Figure 27 provides an example of a bidirectional test result showing the cumulative PMD of an 18.9-km SMF with splices and PMD emulators. Connectors are also used at both ends.

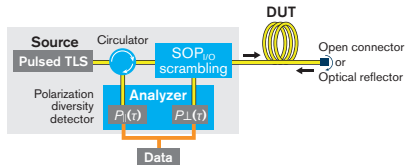

Figure 26 – Single-End Roundtrip Configurations with Pulsed TLS, Combined  $SOP_I$  and  $SOP_O$  Scrambling and PDD

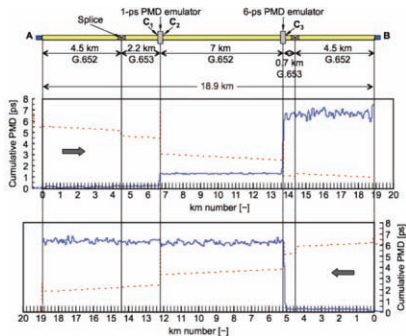

Figure 27 – Example of SSA Cumulative PMD Test Result as a Function of Distance



## 7.2 Uncertainty in PMD Tests and Measurements

The uncertainty of PMD test and measurement results is based on two elements, as shown in Figure 28.

The first element is the measurement uncertainty as per the selected instrumental implementation and equipment parameter settings.

The second element is the fundamental uncertainty of the selected frequency/wavelength range and the PMD value. This is called Gisin's Uncertainty, and this is what, in many conditions, limits the measurement and/or accuracy of low PMD values. This uncertainty is fairly small in absolute terms, but can be significant with low PMD measurements (relatively speaking).

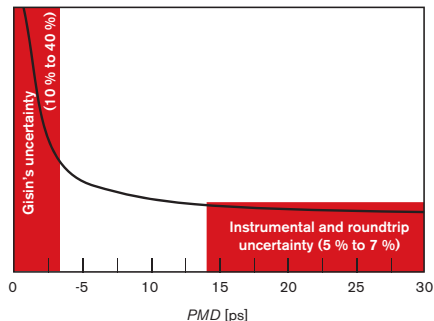

Figure 28 – Example of Typical Experimental Uncertainty

## 7.3 Calibration of PMD Test and Measurement Instruments

The calibration of a PMD test instrument, like any other test instrument, must be done using a traceability process and a set of procedures that involve a number of critical steps.

The first step consists in using standard reference material (SRM), designed by and available from an internationally recognized independent national metrology laboratory (INML). This SRM is provided with a calibration certificate stating the guaranteed value of PMD and its uncertainty obtained from DGD measured over a fixed frequency/wavelength range at precise controlled environmental conditions. To obtain a guaranteed value, the INML designs and builds its own instrumentation in its own laboratory.

### 7.3.1 Applicability Matrix for the Available PMD Test Methods

Table 9 gives an overview of the PMD test methods and their applications.

Table 9 — Applicability of PMD Test Methods

	Available PMD Test Methods			
	FA-FT	INTY		SSA
		TINTY	GINTY	
Configuration	E2E	E2E	E2E	1E
Applications	RMC	RMC	Any MC	Any MC
Conditions	PMD > 1 ps, long fiber		X	
Fibers and cables in factory	PMD > 1 ps, long fiber		X	
Passive components in factory				
Pumped amplifiers in factory				
Aerial links in the field	PMD > 1 ps, long fiber		X	X
Unamplified links in the field	PMD > 1 ps, long fiber		X	X
Amplified links in the field	With TLS/OSA PMD > 1 ps, long fiber		X	

## Acknowledgements

This guide would not have been possible without the enthusiasm and teamwork of EXFO staff, particularly the hard work and technical expertise of the Product Line Management team.

No part of this guide may be reproduced in any form  
or by any means without the prior written permission of EXFO.

Printed and bound in Canada

ISBN 978-1-55342-102-3

Legal Deposit-National Library of Canada 2012  
Legal Deposit-National Library of Quebec 2012



For details on any of our products and services, or to download technical and application notes, visit our website at [www.EXFO.com](http://www.EXFO.com).

**EXFO**